

ProMix[®] 2KS

312776L

Plural Component Proportioner

EN

Manual system for proportional mixing of plural component coatings.
For professional use only.

Approved for use in explosive atmospheres (except the EasyKey).



Important Safety Instructions

Read all warnings and instructions in this manual. Save these instructions.

See page 4 for model information, including maximum working pressure. Equipment approval labels are on page 3. Some components shown are not included with all systems.

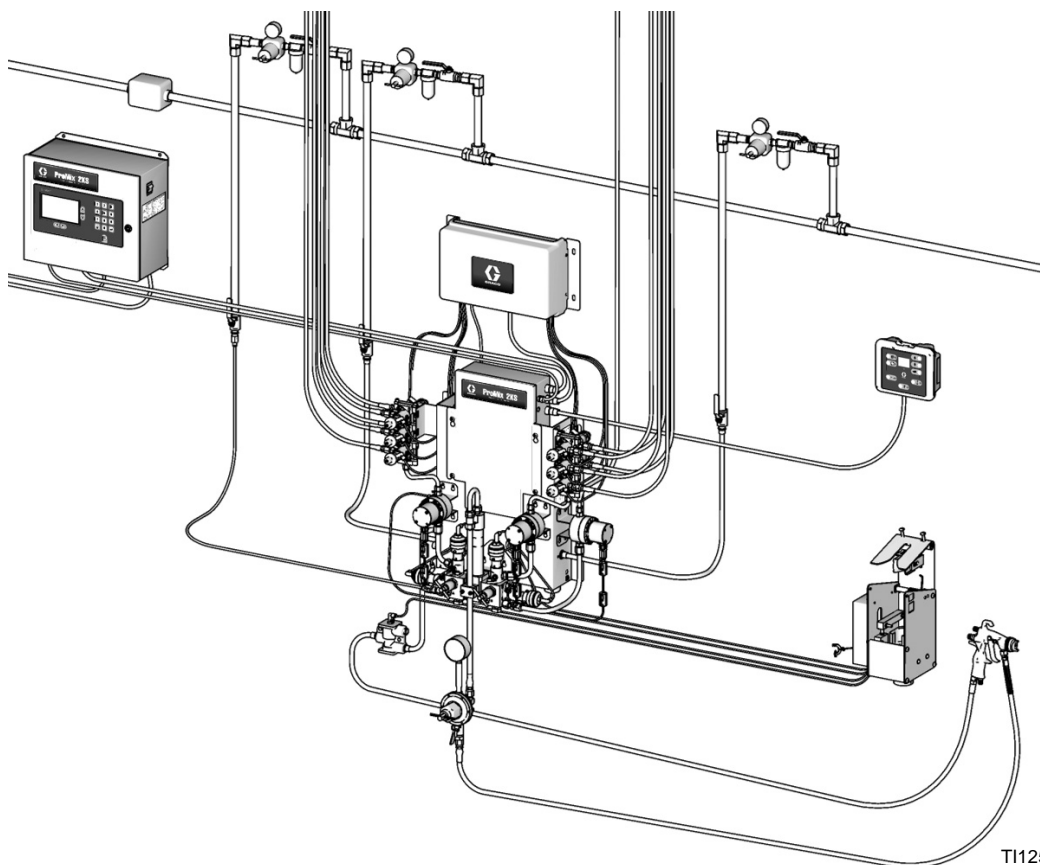

Contents

Related Manuals	3	Recipe Setup Screens	40
Equipment Approvals	3	Recipe 0 Screens	45
System Configuration and Part Numbers	4	Calibration Screen	47
Configurator Key	4	System Operation	48
Standard Features	6	Operation Modes	48
Accessories	6	Sequential Dosing	48
2KS Accessories	6	Dynamic Dosing	48
2KS Acid Compatible Accessories	6	Recipe (Color) Change	48
Warnings	7	Solvent Push	48
Important Two-Component Material Information .	9	Mix Fill Push	48
Isocyanate Conditions	9	General Operating Cycle, Sequential Dosing .	48
Material Self-ignition	9	General Operating Cycle, Dynamic Dosing . . .	50
Keep Components A and B Separate	9	Mix Manifold Valve Settings	53
Moisture Sensitivity of Isocyanates	10	Air Flow Switch (AFS) Function	54
Changing Materials	10	Start Up	55
Important Acid Catalyst Information	11	Shutdown	57
Acid Catalyst Conditions	11	Pressure Relief Procedure	57
Moisture Sensitivity of Acid Catalysts	11	Purging	61
Glossary of Terms	12	Solvent Push Feature	65
Overview	15	Mix Fill Push Feature	66
Usage	15	Meter Calibration	67
Component Identification and Definition	15	Color Change	69
Booth Control	19	Color Change Procedures	69
EasyKey Display and Keypad	20	Color Change Sequences	69
Display	20	Alarms and Warnings	82
Keypad	20	System Alarms	82
AC Power Switch	21	System Warnings	82
I/S Power	21	Alarm Troubleshooting	83
Audible Alarm	21	Schematic Diagrams	94
Graco Web Interface Port	21	System Pneumatic Schematic	94
Ethernet Connection	21	System Electrical Schematic	95
Run Mode Screens	22	EasyKey Electrical Schematic	97
Splash Screen	22	Meter Performance Data (G3000 on A and B) . . .	98
Status Screen	24	Meter Performance Data (G3000 on A, Coriolis	
Totals Screen	25	on B)	99
Reset Total Screen	25	Technical Data	101
Reset Solvent Screen	25	Graco Standard Warranty	102
Alarms Screens	26	Graco Information	102
Level Control Screen	26		
Setup Mode	27		
Password Screen	28		
Set Up Home Screen	28		
System Configuration Screens	30		
Option Screens	34		
Advanced Setup Screens	36		

Related Manuals

Component Manuals in English

Manual	Description
312775	ProMix 2KS Manual System Installation
312777	ProMix 2KS Manual System Repair-Parts
312781	Fluid Mix Manifold
312782	Dispense Valve
312783	Color Change Valve Stacks
312787	Color Change Module Kit
312784	Gun Flush Box Kits
310745	Gun Air Shutoff Kit
312786	Dump Valve and Third Purge Valve Kits
312785	Network Communication Kits
308778	G3000/G3000HR Flow Meter
313599	Coriolis Flow Meter
313290	Floor Stand Kit
313542	Beacon Kit
313386	Basic Web Interface/Advanced Web Interface
406799	15V256 Automatic System Upgrade Kit
406800	15V825 Discrete I/O Board Kit

Equipment Approvals

Equipment approvals appear on the following labels which are attached to the Fluid Station and EasyKey™. See FIG. 1 on page 5 for label locations.

EasyKey and Fluid Station Label

ATEX Certificate is listed here

ProMix 2KS Electronic Proportioner

Intrinsically Safe (IS) System. Install per IS Control Drawing No. 289833. EasyKey Interface IS Associated Apparatus for use in non hazardous location, with IS Connection to Smart Fluid Plate IS Apparatus for use in: Class I, Division 1, Group D T3 Hazardous Locations

Read Instruction Manual
Warning: Substitution of components may impair intrinsic safety.

Part No. Series Serial

--	--	--

MFG. YR.

--

MPa bar PSI
MAX AIR WPR

.7	7	100
----	---	-----

MPa bar PSI
MAX FLUID WPR

--	--	--

MPa bar PSI
MAX TEMP 50°C (122°F)

CE 2575

FM Approved Intrinsic safe equipment for Class I, Div 1, Group D, T3 Ta = -20°C to 50°C

Ex ia IIA T3

GRACO INC. P.O. Box 1441 Minneapolis, MN 55440 U.S.A.

Fluid Station Label

ProMix 2KS FLUID PANEL

Part No. Series Serial Mfg. Yr.

--	--	--	--

MPa bar PSI
MAX AIR WPR

.7	7	100
----	---	-----

MPa bar PSI
MAX FLUID WPR

--	--	--

MPa bar PSI
MAX TEMP 50°C (122°F)

CE 2575

FM Approved Intrinsic safe equipment for Class I, Div 1, Group D, T3 Ta = -20°C to 50°C

Ex ia IIA T3

GRACO INC. P.O. Box 1441 Minneapolis, MN 55440 U.S.A.

T113581b

ATEX Certificate is listed here

EasyKey Label

ProMix 2KS POWER REQUIREMENTS

Part No. Series No. Mfg. Yr.

--	--	--

VOLTS **85-250 ~**

AMPS **2 AMPS MAX**

50/60 Hz

Um: 250 V

CE 2575

FM Approved Intrinsic safe connections for Class I, Div 1, Group D Ta = -20°C to 50°C

Ex ia IIA

GRACO INC. P.O. Box 1441 Minneapolis, MN 55440 U.S.A.

T113582b

ATEX Certificate is listed here

System Configuration and Part Numbers

Configurator Key

The configured part number for your equipment is printed on the equipment identification labels. See Fig. 1 for location of the identification labels. The part number includes one digit from each of the following six categories, depending on the configuration of your system.

Manual System	Control and Display	A and B Meter	Color Valves	Catalyst Valves	Applicator Handling
M	D = EasyKey with LCD Display	0 = No Meters 1 = G3000 (A and B) 2 = G3000HR (A and B) 3 = 1/8 in. Coriolis (A) and G3000 (B) 4 = G3000 (A) and 1/8 in. Coriolis (B) 5 = 1/8 in. Coriolis (A) and G3000HR (B) 6 = G3000HR (A) and 1/8 in. Coriolis (B) 7 = 1/8 in. Coriolis (A and B)	0 = No Valves (single color) 1 = Two Valves (low pressure) 2 = Four Valves (low pressure) 3 = Seven Valves (low pressure) 4 = Twelve Valves (low pressure) 5 = Two Valves (high pressure) 6 = Four Valves (high pressure)	0 = No Valves (single catalyst) 1 = Two Valves (low pressure) 2 = Four Valves (low pressure) 3 = Two Valves (high pressure)	1 = One Air Flow Switch Kit 2 = Two Air Flow Switch Kits 3 = One Gun Flush Box Kit 4 = Two Gun Flush Box Kits
M (acid models)	E = EasyKey with LCD Display	1 = G3000 (A) and G3000A (B)	0 = No Valves (no color; need to order acid kit 26A096-26A100; see page 6)	0 = No Valves (single catalyst)	1 = One Air Flow Switch Kit 2 = Two Air Flow Switch Kits 3 = One Gun Flush Box Kit 4 = Two Gun Flush Box Kits

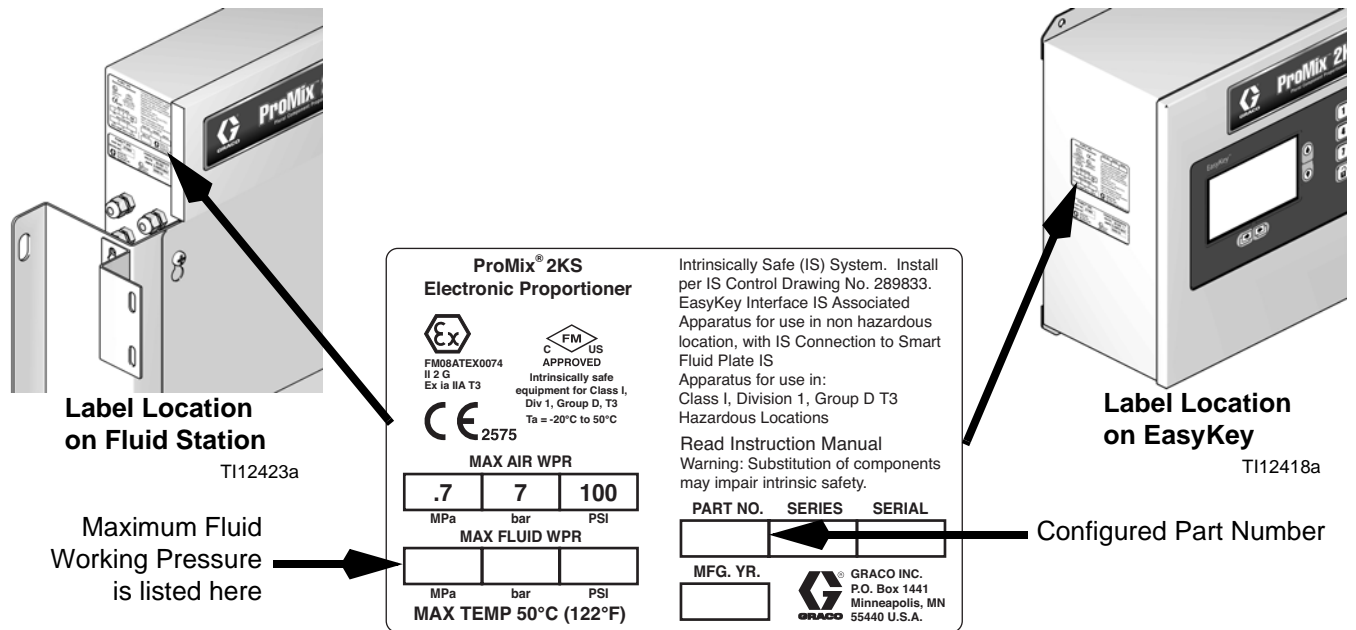

FIG. 1: Identification Label

Hazardous Location Approval

Models using a G3000, G3000HR, G3000A, or intrinsically safe Coriolis meter for both A and B meters are approved for installation in a Hazardous Location - Class I, Div I, Group D, T3 or Zone I Group IIA T3.

Maximum Working Pressure

Maximum working pressure rating is dependent on the fluid component options selected. **The pressure rating is based on the rating of the lowest rated fluid component.** Refer to the component pressure ratings below.
Example: Model MD2531 has a maximum working pressure of 3000 psi (21 MPa, 210 bar).

Check the identification label on the EasyKey or fluid station for the system maximum working pressure. See Fig. 1.

ProMix Fluid Components Maximum Working Pressure

Base System (no meters [option 0], no color/catalyst change [option 0])	4000 psi (27.58 MPa, 275.8 bar)
Meter Option 1 and 2 (G3000 or G3000HR)	4000 psi (27.58 MPa, 275.8 bar)
Meter Option 3, 4, 5, 6, and 7 (one or two Coriolis Meters)	2300 psi (15.86 MPa, 158.6 bar)
Meter Option 8 (G3000 and G3000A)	4000 psi (27.58 MPa, 275.8 bar)
Color Change Option 1, 2, 3 and 4 and Catalyst Change Option 1 and 2 (low pressure valves)	300 psi (2.07 MPa, 20.6 bar)
Color Change Option 5 and 6 and Catalyst Change Option 3 (high pressure valves)	3000 psi (21 MPa, 210 bar)

Flow Meter Fluid Flow Rate Range

G3000 and G3000A	75-3800 cc/min. (0.02-1.0 gal./min.)
G3000HR	38-1900 cc/min. (0.01-0.50 gal./min.)
Coriolis Meter	20-3800 cc/min. (0.005-1.00 gal./min.)
S3000 Solvent Meter (accessory)	38-1900 cc/min. (0.01-0.50 gal./min.)

Standard Features

Feature
EasyKey with LCD
Fiber Optic and Power Cables, 50 ft (15.25 m)
Wall Mount Fluid Station, 50 cc Integrator and Static Mixer
B Side Dump Valve, if multiple catalyst valves
Booth Control
Basic Web Interface

Accessories

2KS Accessories

Accessory
Gun Flush Box Gun Insert Selection
15V354 Third Purge Valve Kit
15V536 Solvent Flow Switch Kit
15V213 Power Cable, 100 ft (30.5 m)
15G710 Fiber Optic Cable, 100 ft (30.5 m)
15U955 Injection Kit for Dynamic Dosing
15V034 10 cc Integrator Kit
15V033 25 cc Integrator Kit
15V021 50 cc Integrator Kit
24B618 100 cc Integrator Kit
15W034 Strobe Light Alarm Indicator Kit
15V337 Advanced Web Interface
15V256 Automatic Mode Upgrade Kit
16D329 S3000 Solvent Flow Meter Kit
15V825 Discrete I/O Integration Board Kit

2KS Acid Compatible Accessories





Intended for use with acid catalyst materials.





Accessory
26A096 No Color /1 Catalyst Change Kit
26A097 2 Color/1 Catalyst Change Kit
26A098 4 Color/1 Catalyst Change Kit
26A099 7 Color/1 Catalyst Change Kit
26A100 12 Color/1 Catalyst Change Kit

NOTE: This is not a complete list of available accessories and kits. Refer to the Graco website for more information about accessories available for use with this product.

Warnings

The following warnings are for the setup, use, grounding, maintenance, and repair of this equipment. The exclamation point symbol alerts you to a general warning and the hazard symbols refer to procedure-specific risks. When these symbols appear in the body of this manual, refer back to these Warnings. Product-specific hazard symbols and warnings not covered in this section may appear throughout the body of this manual where applicable.

 WARNING	
	<p>FIRE AND EXPLOSION HAZARD</p> <p>Flammable fumes, such as solvent and paint fumes, in work area can ignite or explode. To help prevent fire and explosion:</p> <ul style="list-style-type: none"> • Use equipment only in well ventilated area. • Eliminate all ignition sources; such as pilot lights, cigarettes, portable electric lamps, and plastic drop cloths (potential static arc). • Keep work area free of debris, including solvent, rags and gasoline. • Do not plug or unplug power cords, or turn power or light switches on or off when flammable fumes are present. • Ground all equipment in the work area. See Grounding instructions. • Use only grounded hoses. • Hold gun firmly to side of grounded pail when triggering into pail. • If there is static sparking or you feel a shock, stop operation immediately. Do not use equipment until you identify and correct the problem. • Keep a working fire extinguisher in the work area.
	<p>ELECTRIC SHOCK HAZARD</p> <p>This equipment must be grounded. Improper grounding, setup, or usage of the system can cause electric shock.</p> <ul style="list-style-type: none"> • Turn off and disconnect power at main switch before disconnecting any cables and before servicing equipment. • Connect only to grounded power source. • All electrical wiring must be done by a qualified electrician and comply with all local codes and regulations.
	<p>INTRINSIC SAFETY</p> <p>Intrinsically safe equipment that is installed improperly or connected to non-intrinsically safe equipment will create a hazardous condition and can cause fire, explosion, or electric shock. Follow local regulations and the following safety requirements.</p> <ul style="list-style-type: none"> • Only models with a G3000, G250, G3000HR, G250HR, G3000A, or intrinsically safe Coriolis meter are approved for installation in a Hazardous Location - Class I, Div I, Group D, T3 or Zone I Group IIA T3. • Do not install equipment approved only for a non-hazardous location in a hazardous area. See the ID label for the intrinsic safety rating of your model. • Do not substitute or modify system components as this may impair intrinsic safety.

 WARNING	
	<p>SKIN INJECTION HAZARD</p> <p>High-pressure fluid from gun, hose leaks, or ruptured components will pierce skin. This may look like just a cut, but it is a serious injury that can result in amputation. Get immediate surgical treatment.</p> <ul style="list-style-type: none"> • Tighten all fluid connections before operating the equipment. • Do not point gun at anyone or at any part of the body. • Do not put your hand over the spray tip. • Do not stop or deflect leaks with your hand, body, glove, or rag. • Follow Pressure Relief Procedure in this manual, when you stop spraying and before cleaning, checking, or servicing equipment.
	<p>EQUIPMENT MISUSE HAZARD</p> <p>Misuse can cause death or serious injury.</p> <ul style="list-style-type: none"> • Do not operate the unit when fatigued or under the influence of drugs or alcohol. • Do not exceed the maximum working pressure or temperature rating of the lowest rated system component. See Technical Data in all equipment manuals. • Use fluids and solvents that are compatible with equipment wetted parts. See Technical Data in all equipment manuals. Read fluid and solvent manufacturer's warnings. For complete information about your material, request MSDS forms from distributor or retailer. • Check equipment daily. Repair or replace worn or damaged parts immediately with genuine manufacturer's replacement parts only. • Do not alter or modify equipment. • Use equipment only for its intended purpose. Call your distributor for information. • Route hoses and cables away from traffic areas, sharp edges, moving parts, and hot surfaces. • Do not kink or over bend hoses or use hoses to pull equipment. • Keep children and animals away from work area. • Comply with all applicable safety regulations.
	<p>TOXIC FLUID OR FUMES HAZARD</p> <p>Toxic fluids or fumes can cause serious injury or death if splashed in the eyes or on skin, inhaled, or swallowed.</p> <ul style="list-style-type: none"> • Read MSDS's to know the specific hazards of the fluids you are using. • Store hazardous fluid in approved containers, and dispose of it according to applicable guidelines. • Always wear chemically impermeable gloves when spraying or cleaning equipment.
	<p>PERSONAL PROTECTIVE EQUIPMENT</p> <p>You must wear appropriate protective equipment when operating, servicing, or when in the operating area of the equipment to help protect you from serious injury, including eye injury, inhalation of toxic fumes, burns, and hearing loss. This equipment includes but is not limited to:</p> <ul style="list-style-type: none"> • Protective eyewear • Clothing and respirator as recommended by the fluid and solvent manufacturer • Gloves • Hearing protection

Important Two-Component Material Information

Isocyanates (ISO) are catalysts used in two component materials.

Isocyanate Conditions

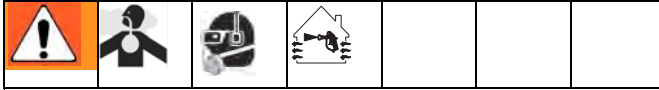

Spraying or dispensing materials that contain isocyanates creates potentially harmful mists, vapors, and atomized particulates.

- Read and understand the fluid manufacturer's warnings and Safety Data Sheet (SDS) to know specific hazards and precautions related to isocyanates.
- Use of isocyanates involves potentially hazardous procedures. Do not spray with this equipment unless you are trained, qualified, and have read and understood the information in this manual and in the fluid manufacturer's application instructions and SDS.
- Use of incorrectly maintained or mis-adjusted equipment may result in improperly cured material. Equipment must be carefully maintained and adjusted according to instructions in the manual.
- To prevent inhalation of isocyanate mists, vapors, and atomized particulates, everyone in the work area must wear appropriate respiratory protection. Always wear a properly fitting respirator, which may include a supplied-air respirator. Ventilate the work area according to instructions in the fluid manufacturer's SDS.
- Avoid all skin contact with isocyanates. Everyone in the work area must wear chemically impermeable gloves, protective clothing and foot coverings as recommended by the fluid manufacturer and local regulatory authority. Follow all fluid manufacturer recommendations, including those regarding handling of contaminated clothing. After spraying, wash hands and face before eating or drinking.

Material Self-ignition



Some materials may become self-igniting if applied too thick. Read material manufacturer's warnings and Safety Data Sheet (SDS).

Keep Components A and B Separate



Cross-contamination can result in cured material in fluid lines which could cause serious injury or damage equipment. To prevent cross-contamination:

- **Never** interchange component A and component B wetted parts.
- Never use solvent on one side if it has been contaminated from the other side.

Moisture Sensitivity of Isocyanates

Exposure to moisture (such as humidity) will cause ISO to partially cure; forming small, hard, abrasive crystals, which become suspended in the fluid. Eventually a film will form on the surface and the ISO will begin to gel, increasing in viscosity.

NOTICE

Partially cured ISO will reduce performance and the life of all wetted parts.

- Always use a sealed container with a desiccant dryer in the vent, or a nitrogen atmosphere. **Never** store ISO in an open container.
- Keep the ISO pump wet cup or reservoir (if installed) filled with appropriate lubricant. The lubricant creates a barrier between the ISO and the atmosphere.
- Use only moisture-proof hoses compatible with ISO.
- Never use reclaimed solvents, which may contain moisture. Always keep solvent containers closed when not in use.
- Always lubricate threaded parts with an appropriate lubricant when reassembling.

NOTE: The amount of film formation and rate of crystallization varies depending on the blend of ISO, the humidity, and the temperature.

Changing Materials

NOTICE

Changing the material types used in your equipment requires special attention to avoid equipment damage and downtime.

- When changing materials, flush the equipment multiple times to ensure it is thoroughly clean.
- Always clean the fluid inlet strainers after flushing.
- Check with your material manufacturer for chemical compatibility.
- When changing between epoxies and urethanes or polyureas, disassemble and clean all fluid components and change hoses. Epoxies often have amines on the B (hardener) side. Polyureas often have aminies on the A (resin) side.

Important Acid Catalyst Information

The 2KS Plural Component Proportioner is designed for acid catalysts (“acid”) currently used in two-component, wood-finishing materials. Current acids in use (with pH levels as low as 1) are more corrosive than earlier acids. More corrosion-resistant wetted materials of construction are required, and must be used without substitution, to withstand the increased corrosive properties of these acids.

Acid Catalyst Conditions



Acid is flammable, and spraying or dispensing acid creates potentially harmful mists, vapors, and atomized particulates. To help prevent fire and explosion and serious injury:

- Read and understand the fluid manufacturer’s warnings and Safety Data Sheet (SDS) to know specific hazards and precautions related to the acid.
- Use only genuine, manufacturer’s recommended acid-compatible parts in the catalyst system (hoses, fittings, etc). A reaction may occur between any substituted parts and the acid.
- To prevent inhalation of acid mists, vapors, and atomized particulates, everyone in the work area must wear appropriate respiratory protection. Always wear a properly fitting respirator, which may include a supplied-air respirator. Ventilate the work area according to instructions in the acid manufacturer’s SDS.
- Avoid all skin contact with acid. Everyone in the work area must wear chemically impermeable gloves, protective clothing, foot coverings, aprons, and face shields as recommended by the acid manufacturer and local regulatory authority. Follow all fluid manufacturer recommendations, including those regarding handling of contaminated clothing. Wash hands and face before eating or drinking.
- Regularly inspect equipment for potential leaks and remove spills promptly and completely to avoid direct contact or inhalation of the acid and its vapors.
- Keep acid away from heat, sparks, and open flames. Do not smoke in the work area. Eliminate all ignition sources.
- Store acid in the original container in a cool, dry, and well-ventilated area away from direct sunlight and away from other chemicals in accordance with acid manufacturer’s recommendations. To avoid corrosion of containers, do not store acid in substitute containers. Reseal the original container to prevent vapors from contaminating the storage space and surrounding facility.

Moisture Sensitivity of Acid Catalysts

Acid catalysts can be sensitive to atmospheric moisture and other contaminants. It is recommended the catalyst pump and valve seal areas exposed to atmosphere are flooded with ISO oil, TSL, or other compatible material to prevent acid build-up and premature seal damage and failure.

NOTICE
<p>Acid build-up will damage the valve seals and reduce the performance and life of the catalyst pump. To prevent exposing acid to moisture:</p> <ul style="list-style-type: none"> • Always use a sealed container with a desiccant dryer in the vent, or a nitrogen atmosphere. Never store acids in an open container. • Keep the catalyst pump and the valve seals filled with the appropriate lubricant. The lubricant creates a barrier between the acid and the atmosphere. • Use only moisture-proof hoses compatible with acids. • Always lubricate threaded parts with an appropriate lubricant when reassembling.

Glossary of Terms

Advanced Web Interface (AWI) - This allows remote ProMix backup and restore, configuration, logging, and software update options.

Air Chop - the process of mixing air and solvent together during the flush cycle to help clean the lines and reduce solvent usage.

Air Chop Time- duration of each activation of the air purge valve during a chop sequence. User settable from 0.0-99.9 seconds.

Analog - relating to, or being a device in which data are represented by continuously variable, measurable, physical quantities, such as length, width, voltage, or pressure.

B Purge After Chop - Optional 2-second B solvent valve activation after the Chop sequence. This is used to separate the chop material and the Final Purge material to prevent unwanted mixing.

Basic Web Interface (BWI) - This allows remote ProMix backup and restore, logging, and software update options.

Bootloader - The utility program that handles initial system startup re-programming of the main ProMix application.

Chop Time- refers to the total length of the chop sequence during a purge. User settable from 0-999 seconds.

Closed Loop Flow Control - refers to the process when the flow rate is adjusted automatically to maintain a constant flow.

Color/Catalyst Purge - refers to the time required to flush the lines from the color or catalyst change module to the mix manifold during a color or catalyst change.

Color/Catalyst Fill - refers to the time required to fill the lines from the color or catalyst change module to the mix manifold.

Command Holdoff - The amount of time that flow rate learning is not allowed after the set point is changed to allow the flow rate to stabilize.

Coriolis Meter - a non-intrusive flow meter often used in low flow applications or with light viscosity, shear sensitive, or acid catalyzed materials. This meter uses vibration to measure flow.

Custom Language - A method to load a translation file into the ProMix to display languages other than those built into the system. Only Unicode characters through codespace 0x00FF are supported.

Digital Input and Output - a description of data which is transmitted as a sequence of discrete symbols, most commonly this means binary data represented using electronic or electromagnetic signals.

Discrete I/O - refers to data that constitutes a separate entity and has direct communication to another control.

Dose Size - the amount of resin (A) and catalyst (B) that is dispensed into an integrator.

Dose Time Alarm - the amount of time that is allowed for a dose to occur before an alarm occurs. More than 30 pulses from the flow meter of the active dose valve are needed while the Gun Trigger is on to prevent the alarm.

Dynamic Dosing - Component A dispenses constantly. Component B dispenses intermittently in the necessary volume to attain the mix ratio.

Ethernet - a method for directly connecting a computer to a network or equipment in the same physical location.

ExtSP - External Set Point selection for PLC input of the flow rate set point while operating in Flow Control Override mode.

Fiber Optic Communication - the use of light to transmit communication signals. Blue is the transmitter, and black is the receiver. This must be cross-connected between the EasyKey and the Fluid Panel for communication to work. The Fiber Optic cable has a blue band to indicate the proper connection.

Final Purge Source- source of the media used in the final purge cycle. User settable to air purge valve, solvent purge valve, or 3rd purge valve.

Final Purge Time- duration of the final purge cycle. User settable from 0-999 seconds.

First Purge Source- source of the media used in the first purge cycle. User settable to air purge valve, solvent purge valve, or 3rd purge valve

First Purge Time- duration of the first purge cycle. User settable from 0-999 seconds.

Flow Control Resolution - a settable value that allows the flow control system to maximize its performance. The value is based on maximum desired flow rates.

Flow Rate Analog Signal - the type of communication signal that can be used on the ProControl module.

Flow Rate Tolerance - the settable percent of acceptable variance that the system will allow before a flow rate warning occurs.

Flow Set Point - a predefined flow rate target.

Flush Volume Check - system monitors flush volume. E-11 Alarm occurs if minimum volume is not achieved. Minimum flush volume is user settable (0-999 cc).

Global - indicates that values on the screen apply to all recipes, 1 through 60.

Grand Total - a non-resettable value that shows the total amount of material dispensed through the system.

GT-Off Drive Time - The amount of time to regulate the fluid pressure based on the flow rate set point after the gun trigger is closed.

GT-Off Target Rise - The additional time to regulate the fluid pressure based on the flow rate set point after the gun trigger is closed.

Gun Trigger Holdoff - The amount of time that flow rate learning is not allowed after the gun trigger is opened to allow the flow rate to stabilize.

Gun Trigger Input Signal - used to manage ratio assurance dose times and flow control processes.

Intrinsically Safe (IS) - refers to the ability to locate certain components in a hazardous location.

Idle - if the gun is not triggered for 2 minutes the system enters Idle mode. Trigger the gun to resume operation.

Job Total - a resettable value that shows the amount of material dispensed through the system for one job. A job is complete when a color change or complete system flush occurs.

K-factor - a value that refers to the amount of material that passes through a meter. The assigned value refers to an amount of material per pulse.

Kd - refers to the amount the fluid flow system attempts to not overshoot the target set point.

Ki - refers to the degree fluid flow over shoots its set point.

Kp - refers to the speed in which the fluid flow reaches its set point.

Learn Strength - How much and how quickly to apply the difference in the flow rate set point compared to the measured flow rate when updating the flow control data table.

Manual Mode - when the proportioning or flow control system is controlling the inputs without any input from an outside control.

Minimum Material Fill Volume - system monitors material fill volume. E-21 Alarm occurs if minimum volume is not achieved. Minimum material fill volume is user settable (0-9999 cc).

Mix - when cross-linking of the resin (A) and catalyst (B) occurs.

Mix Fill Push - An option for the Autodump selection to automatically clear the Potlife alarm if the gun is in the Gun Flush Box by running new mixed material through the gun.

Mix Input Signal- refers to system mode status where system begins a dose sequence each time the mix signal is made "High".

Mixed Material Fill Time - the amount of time that is required to load mixed material from the dose valves to the applicator/gun.

Modbus/TCP - a type of communication protocol used to communicate Digital I/O signals over an ethernet.

Network Station - a means to identify a particular individual proportioning or flow control system.

One-Point Learning - Flow Control table calibration method using learned points above a specified flow rate to interpolate the table at low flow rates with short gun trigger times.

Overdose (A, B, C) Alarm - when either the resin (A), or catalyst (B), or reducer (C) component dispenses too much material and the system cannot compensate for the additional material.

Potlife Time - the amount of time before a material becomes unsprayable.

Potlife Volume - the amount of material that is required to move through the mix manifold, hose and applicator before the potlife timer is reset.

Purge - when all mixed material is flushed from the system.

Purge Drive - The voltage drive during the Purge sequence, maximum of 3300 mV. The response curve of the V/P regulator is not linear, so it may be necessary to test the response using Manual Override mode.

Purge Time - the amount of time required to flush all mixed material from the system.

Purge Volume Alarm - E-11 Alarm occurs if minimum flush volume is not achieved.

Ratio Tolerance - the settable percent of acceptable variance that the system will allow before a ratio alarm occurs.

Sequential Color Change - the process when a color change is initiated and the system automatically flushes the old color and loads a new color.

Sequential Dosing - Components A and B dispense sequentially in the necessary volumes to attain the mix ratio.

Solvent/3rd Purge Valve Chop Time - duration of each activation of the solvent or 3rd purge valve during a chop sequence. User settable from 0.0-99.9 seconds.

Solvent Fill - the time required to fill the mixed material line with solvent.

Solvent Push - enables the user to save some mixed material by pushing it out to the gun with solvent. Requires an accessory solvent meter.

Standby - refers to the status of the system.

System Idle - This warning occurs if the ProMix is set to Mix, and 2 minutes have elapsed since the system received a flow meter pulse.

Third Purge Valve - refers to the use of three purge valves used to flush some waterborne materials. The valves are used to flush with water, air and solvent.

V/P - refers to the voltage to pressure device in the flow control module.

Valve Holdoff Maximum - The maximum amount of time that flow rate learning is not allowed after a dose valve cycles. The system may internally use a time less than is based on the stability of the fluid meter pulse stream.

Overview

Usage

The Graco ProMix 2KS is an electronic two-component paint proportioner. It can blend most two-component solvent and waterborne epoxy, polyurethane, and acid-catalyzed paints. It is not for use with “quick-setting” paints (those with a potlife of less than 15 minutes).

- Can proportion at ratios from 0.1:1 to 50:1 in 0.1 increments with the wall mount fluid station.
 - Has user selectable ratio assurance and can maintain up to +/-1% accuracy, depending on materials and operating conditions.
 - Models are available to operate air spray or air-assisted systems with a capacity of up to 3800 cc/min.
 - Color change options are available for low pressure (300 psi [2.1 MPa, 21 bar]) air spray and high pressure (3000 psi [21 MPa, 210 bar]) systems with up to 30 color change valves and up to 4 catalyst change valves.
- NOTE:** Optional accessories are available for in field installation to achieve 30 colors.

Component Identification and Definition

See Table 1, FIG. 2, and FIG. 3 for the system components.

Table 1: Component Descriptions

Component	Description
EasyKey (EK)	Used to set up, display, operate, and monitor the system. The EasyKey accepts 85-250 VAC, 50/60 Hz line power and converts that power to acceptable low voltage and optical signals used by other system components.
Booth Control (BC)	Used by the operator for daily painting functions including: choosing recipes, initiating job complete, reading/clearing alarms, and placing the system in Standby, Mix, or Purge mode. It is typically mounted inside the booth or near the painter.
Fluid Station (ST)	Includes air control solenoids, flow switches, and mountings for the fluid flow meters and the fluid manifold assembly. Its control board manages all proportioning functions.
Fluid Manifold (FM)	<ul style="list-style-type: none"> • Pneumatically Operated Dose Valves for component A and B • Purge Valves for solvent and air purge • Sampling Valves for calibrating the flow meters and performing ratio checks • Shutoff Valves for component A and B to close their fluid passages to the mix manifold, to allow for accurate calibration and ratio checks • Mix Manifold, which includes the fluid integrator and static mixer. <ul style="list-style-type: none"> → Fluid Integrator is the chamber where component A and B align at the selected ratio and begin to mix. → Static Mixer has 24 elements to uniformly blend the materials downstream of the fluid integrator.

Table 1: Component Descriptions

Component	Description
Flow Meters (MA, MB, MS)	<p>Three optional flow meters are available from Graco:</p> <ul style="list-style-type: none"> • G3000 is a general purpose gear meter typically used in flow ranges of 75-3800 cc/min. (0.02–1.0 gal/min.), pressures up to 4000 psi (28 MPa, 276 bar), and viscosities of 20–3000 centipoise. The K-factor is approximately 0.119 cc/pulse. • G3000A is a gear meter for use with acid catalyst fluids. It is typically used in flow ranges of 75-3800 cc/min. (0.02–1.0 gal/min.), pressures up to 4000 psi (28 MPa, 276 bar), and viscosities of 20–3000 centipoise. The K-factor is approximately 0.119 cc/pulse. • G3000HR is a high resolution version of the G3000 meter. It is typically used in flow ranges of 38–1900 cc/min. (0.01–0.5 gal/min.), pressures up to 4000 psi (28 MPa, 276 bar), and viscosities of 20–3000 centipoise. The K-factor is approximately 0.061 cc/pulse. • S3000 is a gear meter used for solvents in flow ranges of 38-1900 cc/min. (0.01–0.50 gal/min.), pressures up to 3000 psi (21 MPa, 210 bar), and viscosities of 20–50 centipoise. The K-factor is approximately 0.021 cc/pulse. Required to use the Solvent Push feature. • Coriolis is a specialty meter capable of a wide range of flow rates and viscosities. This meter is available with 1/8 in. or 3/8 in. diameter fluid passages. For detailed information on the Coriolis meter, see manual 313599. The K-factor is user-settable; at lower flow rates use a lower K-factor. <ul style="list-style-type: none"> → 1/8 in. fluid passages: set K-factor to .020 or .061. → 3/8 in. fluid passages: set K-factor to .061 or 0.119.
Color Change Valves (ACV) and Color Change Module (CCM)	An optional component. It is available as a color change valve stack for either low or high pressure with up to 30 color change valves. Each stack includes one additional valve for solvent to clean the fluid line between color changes.
Catalyst Change Valves (BCV)	<p>An optional component. It is available as a catalyst change valve stack for either low or high pressure with up to 4 catalyst change valves. Each stack includes one additional valve for solvent to clean the fluid line between catalyst changes.</p> <p>A different catalyst change valve is used on acid catalyst systems.</p>
Dual Fiber Optic Cable (FO)	Used to communicate between the EasyKey and Wall Mount Fluid Station.
Fluid Station Power Supply Cable (PS)	Used to provide power to the Wall Mount Fluid Station.
Applicator Handling: use Air Flow Switch (AFS) or Gun Flush Box (GFB)	<p>Air Flow Switch: The air flow switch detects air flow to the gun and signals the ProMix controller when the gun is being triggered. The switch functions with the flow meters to ensure that the system components are functioning correctly. See page 54 for further information.</p> <p>Gun Flush Box: The gun flush box kit provides an automated flushing system for manual spray guns, and includes an air flow switch.</p>

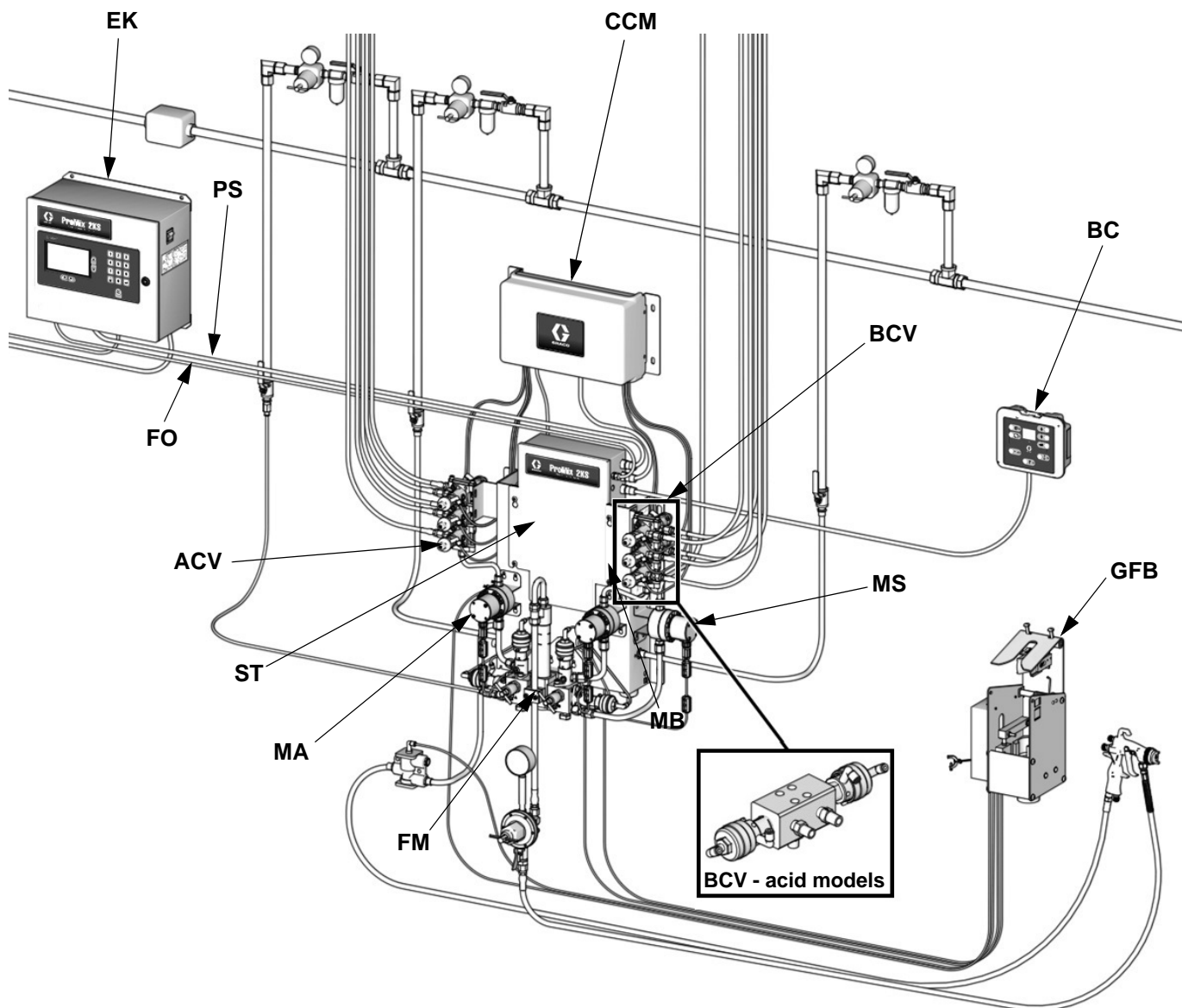

TI29655a

FIG. 2. Manual System, shown with G3000 Meters, Color/Catalyst Change, One Gun Flush Box, and Accessory Solvent Flow Meter

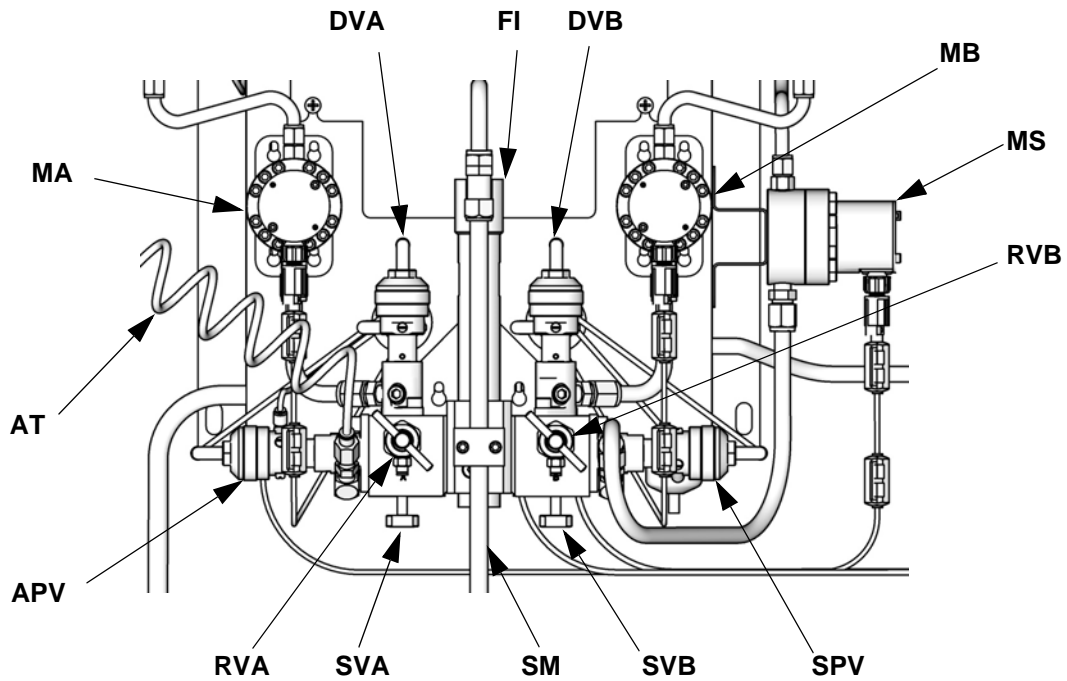

T112556b

FIG. 3. Wall Mount Fluid Station

Key:

- MA Component A Meter
- DVA Component A Dose Valve
- RVA Component A Sampling Valve
- SVA Component A Shutoff Valve
- MB Component B Meter
- DVB Component B Dose Valve
- RVB Component B Sampling Valve
- SVB Component B Shutoff Valve
- MS Solvent Meter (accessory)
- SPV Solvent Purge Valve
- APV Air Purge Valve
- SM Static Mixer
- FI Fluid Integrator
- AT Air Purge Valve Air Supply Tube

Booth Control

Used by the operator for daily painting functions including: changing recipes, signalling job complete, reading/clearing alarms, and placing the system in Standby, Mix, or Purge mode. It is typically mounted inside the booth or near the painter.

Table 2: Booth Control Key and Indicator Functions (see FIG. 4)

Key/Indicator	Definition and Function
Display	<ul style="list-style-type: none"> Displays recipe number in Run mode. If an alarm occurs, displays the alarm code (E1 to E28) and red Alarm indicator blinks. Recipe number displays after alarm is reset. If Solvent Push is on, display alternately shows dashes and the percentage remaining (see page 65).
Recipe Indicator	<ul style="list-style-type: none"> Green LED stays lit while a recipe is in use. LED shuts off when Up ↑ or Down ↓ keys are pressed or if an alarm occurs. LED blinks while a new recipe is loading and turns solid after loading is complete. LED blinks when purging. Select a new recipe by pressing Up ↑ or Down ↓ keys, then pressing Enter ←.
Alarm Reset Key and Indicator	<ul style="list-style-type: none"> Red LED blinks when an alarm occurs. Press key to reset alarm. LED shuts off after alarm is reset.
Job Complete Key and Indicator	<ul style="list-style-type: none"> Signals that job is complete, and resets A and B totalizers. Green LED blinks once after key is pressed.
Enter Key	Enters selected recipe and starts color change sequence.

Table 2: Booth Control Key and Indicator Functions (see FIG. 4)

Key/Indicator	Definition and Function
Up Key	Scrolls recipe numbers up.
Down Key	Scrolls recipe numbers down.
Mix Mode Key	<ul style="list-style-type: none"> Starts Mix mode. Green LED remains lit while in Mix mode or in Idle mode. Press and hold for 5 seconds to turn on the Solvent Push feature.
Standby Mode Key	<ul style="list-style-type: none"> Starts Standby mode. Green LED remains lit while in Standby mode.
Purge Mode Key	<ul style="list-style-type: none"> Starts Purge mode. Green LED remains lit while in Purge mode.

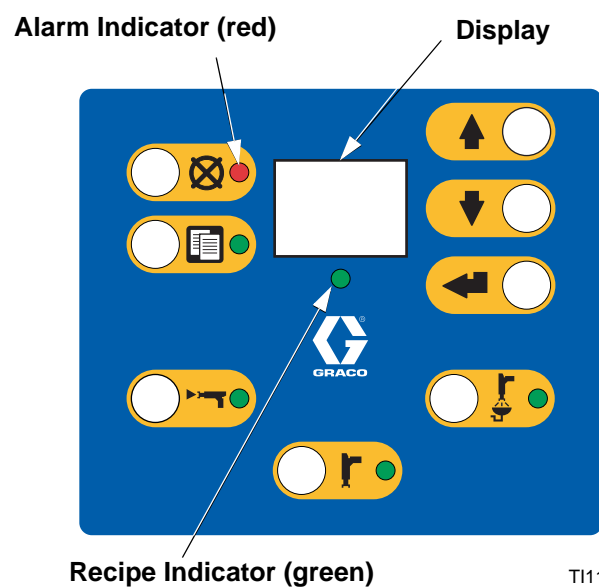
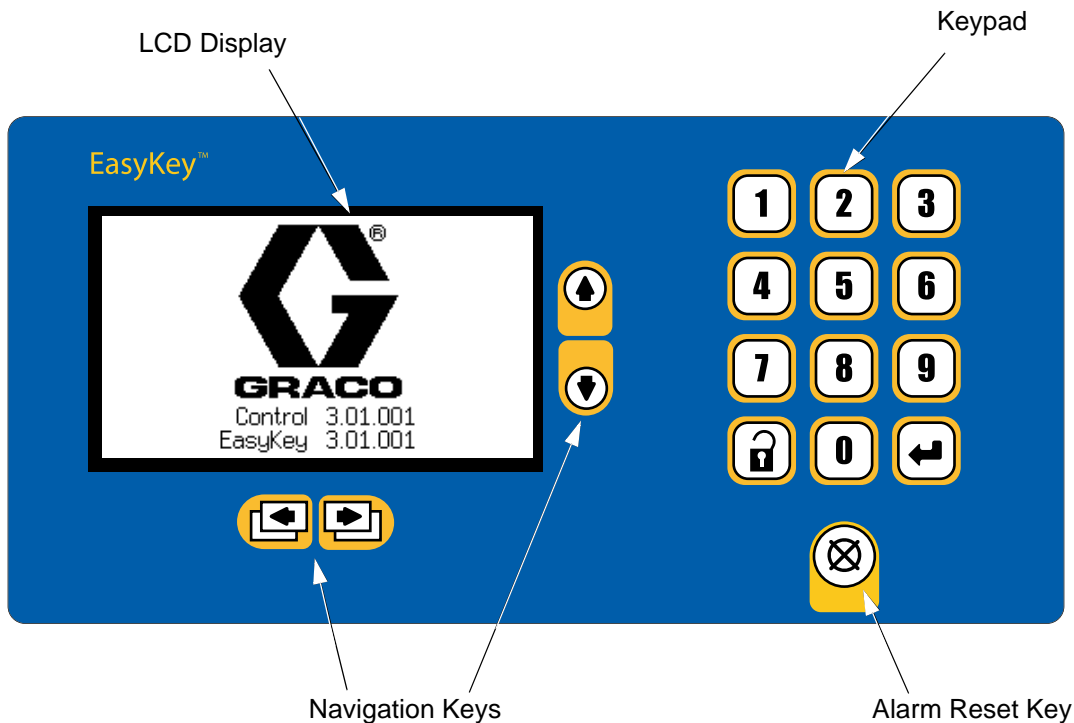

FIG. 4. Booth Control (see Table 2)

TI11614A

EasyKey Display and Keypad



TI11630A

FIG. 5. EasyKey Display and Keypad

Display

Shows graphical and text information related to setup and spray operations. Back light will turn off after 10 minutes without any key press. Press any key to turn back on.

NOTE: Pressing a key to turn on the display back light will also perform the function of that key. If you are unsure whether that key will impact your current operation, use the setup or navigation keys to turn on the display back light.

Keypad

Used to input numerical data, enter setup screens, scroll through screens, and select setup values.

In addition to the numbered keys on the EasyKey keypad, which are used to enter values in setup, there are keys to navigate within a screen and between screens, and to save entered values. See Table 3.

Table 3: EasyKey Keypad Functions (see FIG. 5)

Key	Function
	<i>Setup:</i> press to enter or exit Setup mode.
	<i>Enter:</i> if cursor is in menu box, press Enter key to view menu. Press Enter to save a value either keyed in from the numerical keypad or selected from a menu.
	<i>Up Arrow:</i> move to previous field or menu item, or to previous screen within a group.
	<i>Down Arrow:</i> move to next field or menu item, or to next screen within a group.
	<i>Left Arrow:</i> move to previous screen group.
	<i>Right Arrow:</i> move to next screen group.
	<i>Alarm Reset:</i> resets all active alarms. If the display becomes unresponsive, pressing this key 4 times in succession will re-initialize the display.

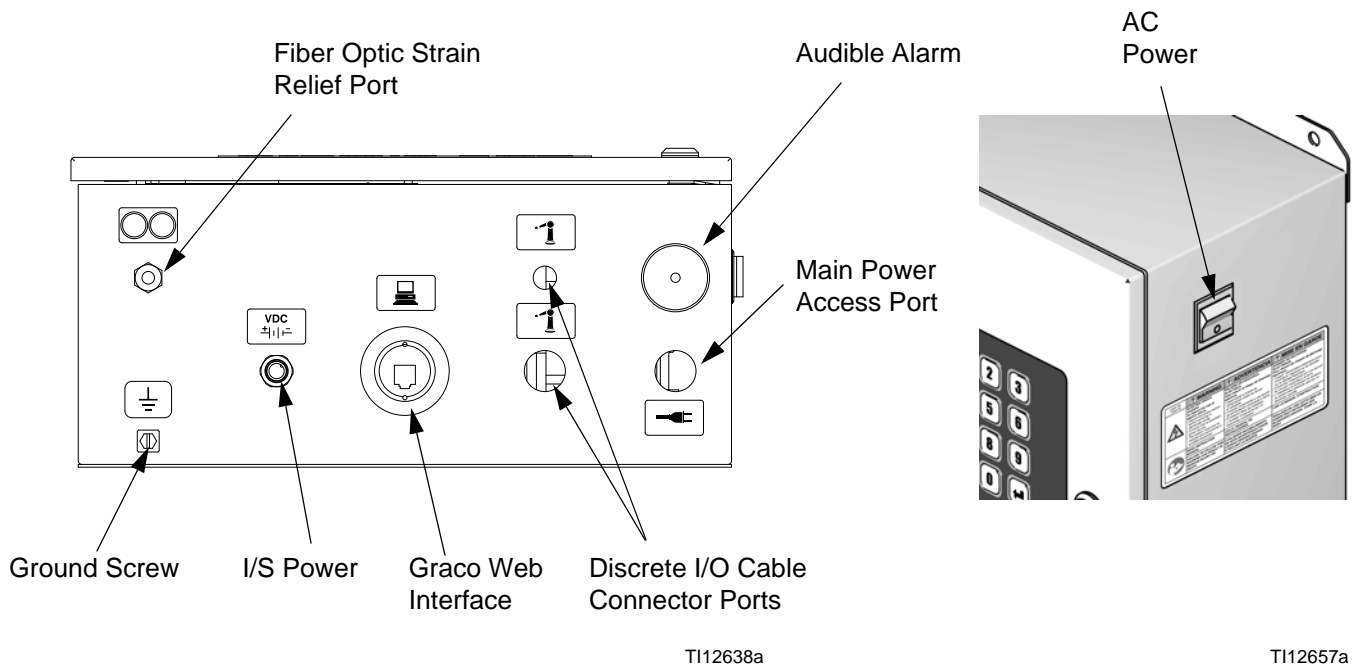

FIG. 6. EasyKey Connections and AC Power Switch

AC Power Switch

Turns system AC power on or off.

I/S Power

Power circuit to Fluid Station.

Audible Alarm

Alerts the user when an alarm occurs. Available settings for selecting which alarms will cause an audible alarm are explained in **Configure Screen 1**, page 31.

Clear the audible alarm by pressing the Alarm Reset



key.

Even after the Alarm Reset key is pressed, the Potlife Exceeded alarm message will remain displayed until a sufficient amount of mixed material has been dispensed to ensure that the expired material has been ejected.

Graco Web Interface Port

Used to communicate from a PC to:

- Upgrade software
- View software version
- Download
 - Job and alarm logs
 - Material usage report
 - Setup values (can also upload)
- Clear job, alarm, and material usage reports
- Upload a custom language to view on screen
- Restore factory defaults
- Restore setup password

See manual 313386 for more information.

Ethernet Connection

You can access data on an office or industrial network through the internet with the proper configuration. See manual 313386 for more information.

Run Mode Screens

NOTE: See FIG. 9 for a map of the Run screens. Detailed screen descriptions follow.

Splash Screen

At power up, the Graco logo and software revision will display for approximately 5 seconds, followed by the **Status Screen** (see page 24).



FIG. 7. Splash Screen

The Splash screen will also momentarily display “Establishing Communication.” If this display remains for more than one minute, check that the fluid station circuit board is powered up (LED is on) and that the fiber optic cable is properly connected (see installation manual).

NOTE: If the software version of the fluid plate does not match the version of the EasyKey, the EasyKey will update the fluid plate, and the fluid plate programming screen will appear until the update is completed.

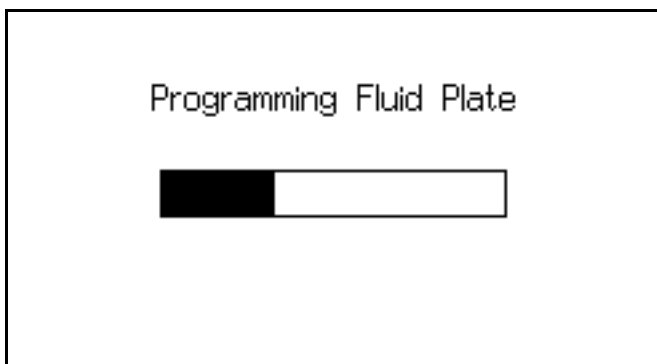
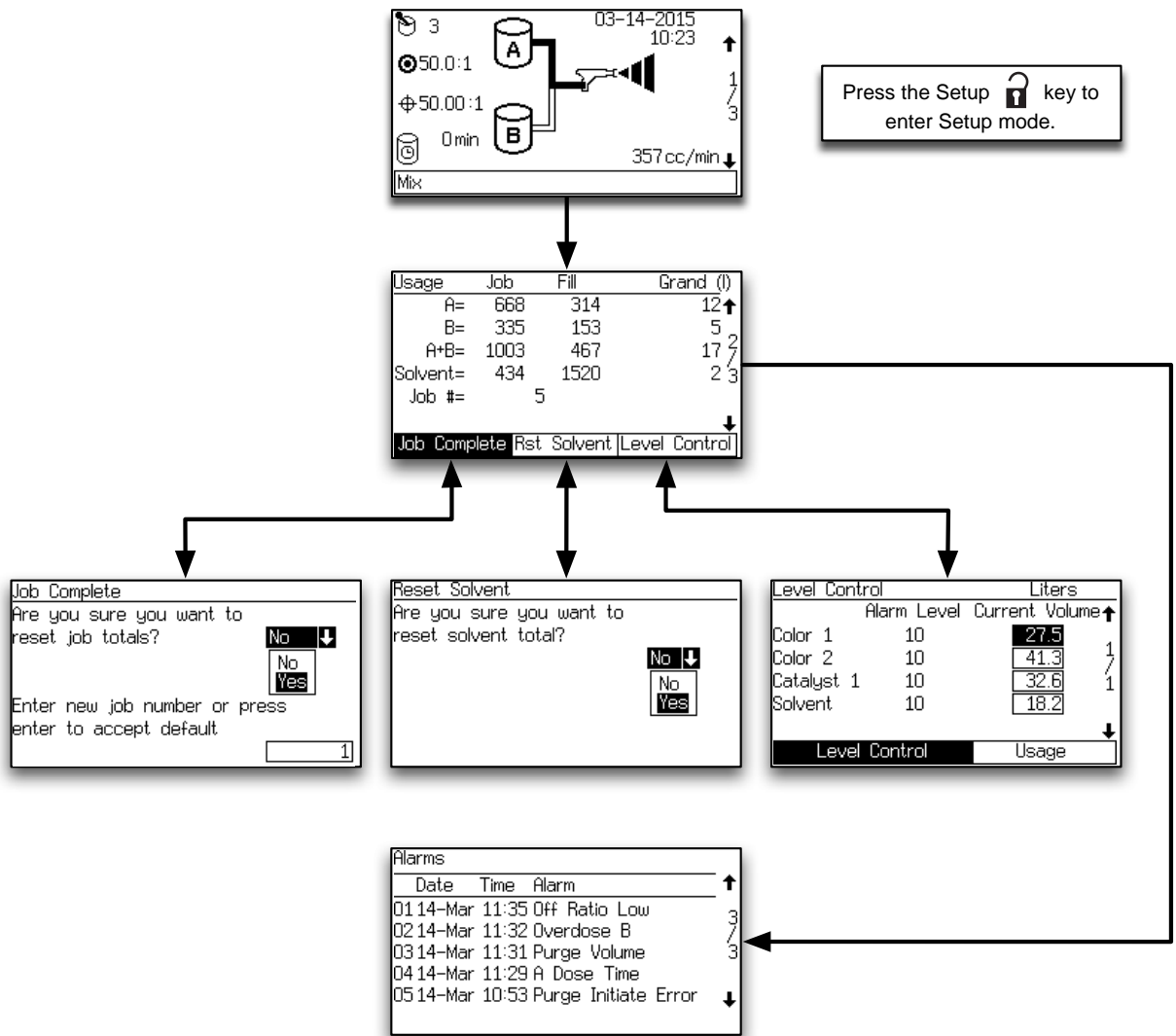





FIG. 8. Fluid Plate Programming Screen



T112783a

FIG. 9. Run Screens Map

Status Screen

- Use the Up  or Down  keys to scroll through the Run screens.
- Press the Setup  key to enter the Setup screens from the Status screen.
- The other keys have no function in this Status screen.

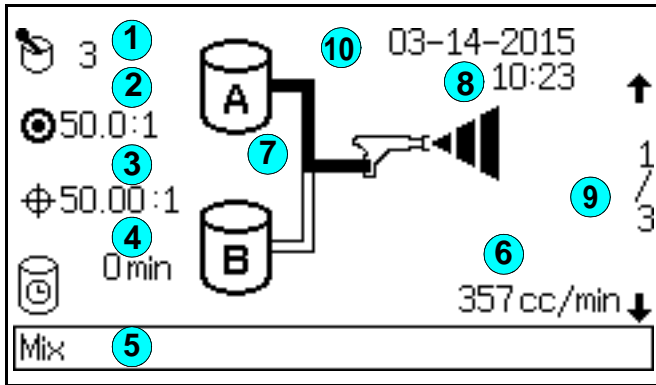

FIG. 10. Status Screen

Key to FIG. 10:

- ① **Active Recipe:** shows the active recipe.
NOTE: At power up the system defaults to Recipe 61, which is not a valid recipe number.
- ② **Target Ratio:** for the active recipe. The ratio can be from 0.0:1–50.0:1, in 0.1 increments.
- ③ **Actual Ratio:** in hundredths, calculated after each dose of A and B.

- ④ **Potlife Timer:** shows remaining potlife time in minutes. Two times are shown if there are two guns.
- ⑤ **Status Bar:** shows current alarm or operation mode (standby, mix, purge, recipe change, or the current alarm).
- ⑥ **Current Flow Rate:** in cc/min.
- ⑦ **Animation:** when the gun is triggered, the gun appears to spray and the component A or B hose lights up, showing which component dose valve is open.
- ⑧ **Current Date and Time**
- ⑨ **Screen Number and Scroll Arrows:** displays the current screen number and the total number of screens in a group. The Up and Down arrows on the right edge of the screen indicate the scroll feature. The total number of screens in some groups may vary depending on system configuration selections.
- ⑩ **Lock Symbol:** indicates that Setup screens are password protected. See page 28.

Totals Screen

Usage	Job	Fill	Grand (l)
A=	668	314	12 ↑
B=	335	153	5
A+B=	1003	467	17 2
Solvent=	434	1520	2 3
Job #=	5		
↓			
Job Complete Rst Solvent Level Control			

FIG. 11. Totals Screen

This screen shows the job totals, fill totals, grand totals, and job number. Use the tabs to reset job totals (Job Complete), reset solvent totals (Rst Solvent), or go to **Level Control Screen**, page 26.

The job totals generally refer to material dispensed while in Mix mode. This is likely atomized and sprayed material with the gun trigger "On".

The fill totals generally refer to material dispensed while in Mix-fill mode after a color change or a purge operation. This is likely not sprayed or atomized, and is dispensed to a purge container.

Solvent Totals and the Rst Solvent tab only appear if "Meter" is selected under Solvent Monitor in **Configure Screen 5** on page 33.

NOTE: Grand totals are not resettable.

Reset Total Screen

Job Complete

Are you sure you want to reset job totals?

No ↓

No
Yes

Enter new job number or press enter to accept default

1

FIG. 12. Reset Total Screen

If job is reset, job number will increment by one for default.

Reset Solvent Screen

Reset Solvent

Are you sure you want to reset solvent total?

No ↓

No
Yes

FIG. 13. Reset Solvent Total Screen

The screen will ask if you want to reset solvent total. Select Yes or No.

Alarms Screens



Alarms			
Date	Time	Alarm	
01	14-Mar 11:35	Off Ratio Low	3
02	14-Mar 11:32	Overdose B	3
03	14-Mar 11:31	Purge Volume	3
04	14-Mar 11:29	A Dose Time	
05	14-Mar 10:53	Purge Initiate Error	

FIG. 14. Alarms Screen

occur after 25% of the remaining volume is mixed. Refill tank volume to clear the alarm.

Warning: Tank Level Low Alarm	
Color 1	10 Liters Alarm Level
	10 Liters Current Volume
1. Refill Tank Volume	
2. Spray 25% of Remainder	
Selection	<input type="radio"/>

FIG. 16. Tank Level Low Screen (Tank A Shown)

Two screens show the last 10 alarms. Use the Up  or Down  keys to scroll between the two screens.

See Table 10 on page 82 for a list of alarm codes.

Level Control Screen

Level Control		Liters	
	Alarm Level	Current Volume	
Color 1	10	27.5	1
Color 2	10	41.3	1
Catalyst 1	10	32.6	1
Solvent	10	18.2	

Level Control Usage

FIG. 15. Level Control Screen

This screen shows the current volume for each fluid. Adjust the current volumes on this screen, or use the tab to go to Usage (**Totals Screen**, page 25). The Alarm Level values may be adjusted using the advanced web interface.

See FIG. 16. If the tank volume reaches the low-level threshold, the EasyKey screen will display the Tank Level Low alarm and prompt the user to do one of the following:

1. Refill tank volume to clear the alarm.
2. Resume mixing by selecting “Spray 25% of Remainder.” If this selection is chosen, a second alarm will

Setup Mode

Press the Setup  key to enter Setup mode.

NOTE: See FIG. 17 for a map of the Setup screens. Detailed screen descriptions follow.

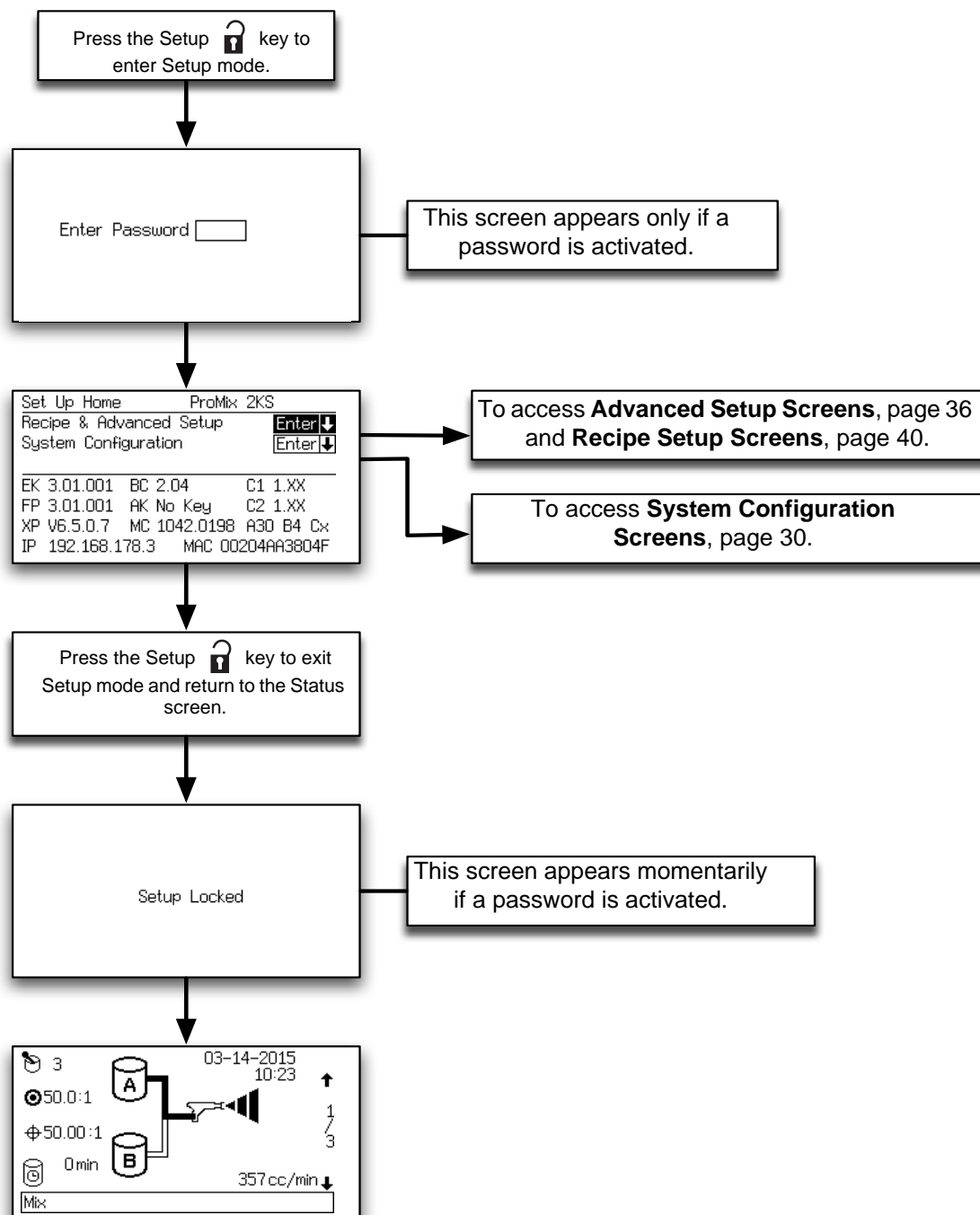

T112784a

FIG. 17. Setup Screens Map

Password Screen

If a password has been activated (see **Configure Screen 1**, page 31), the Password screen will appear. You must enter the password to access the **Set Up Home Screen**. Entering the wrong password returns the display to the **Status Screen**.

NOTE: If you forget the password, you can reset the password (to 0), using the ProMix 2KS Web Interface (see manual 313386).

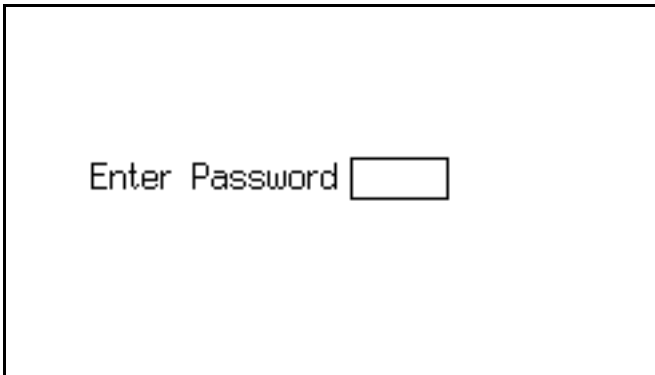

FIG. 18. Password Screen

NOTE: If a password is activated, **Setup Locked** displays momentarily after exiting Setup mode and returning to the **Status Screen**. A lock  symbol appears on the **Status Screen**.



FIG. 19. Setup Locked Screen

Set Up Home Screen

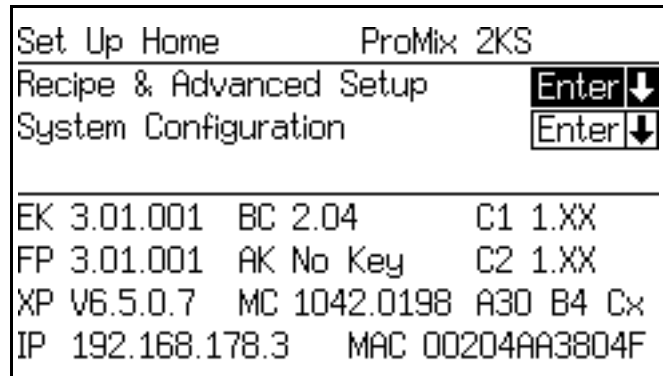



FIG. 20. Set Up Home Screen

This screen displays when you enter Setup mode. From it you can go to **Recipe and Advanced Setup Screens** (pages 36-44) or **System Configuration Screens** (pages 30-33). Press the Enter  key to go to the selected screen set.

The screen also displays software versions and internet addresses of various components. The values shown in FIG. 20 are only examples and may vary on your screen. See Table 4 for further information.

Table 4: Component Software Versions

Component	Display (may vary from examples shown)	Description
EK (EasyKey)	3.01.001	EasyKey software version.
FP (Fluid Plate)	3.01.001	Fluid Plate software version.
BC (Booth Control)	.-	Booth Control not installed, not detected, or not operational.
	1.XX	Booth Control software version 1.00 or 1.01.
	2.XX	Booth Control software version 2.XX.
C1/C2 (Color Change Modules 1 and 2)	.-	Color Change Module 1/2 not installed, not detected, or not operational.
	1.XX	Color Change Module software version 1.00 or 1.01.
	2.XX	Color Change Module software version 2.XX.
AK (Autokey)	No Key	No AutoKey installed or detected. System operates in 2K Manual Mode only
	2K-Auto	2K AutoKey detected. System can operate in 2K Manual, Semi-automatic, or Automatic Mode.
	3K-Auto	3K AutoKey detected. System can operate in 3K Manual, Semi-automatic, or Automatic Mode.
XP (XPORT)	V6.6.0.2	Example of XPORT network module software version. Other versions are acceptable.
MC (Micro Controller)	1042.0198	Example of fluid plate micro controller version. Other versions are acceptable.
Axx By Cz	A30 B4 Cx	Color Change board valve configuration. This shows the number of valves available for each of the components. This is set by the configuration switches on the color change boards connected to the system.
		Code Description
		- Component not available with this machine configuration.
		x Component not used with this machine configuration.
		1 Component available but no change stack.
		4-30 Component available with change stack. Number of valves flushed with a solvent valve.
IP (Internet Address)	192.168.178.3	Example of the address EasyKey is set to for basic and advanced web interface reporting.
MAC (MAC address)	00204AAD1810	Example of internet MAC address. Each EasyKey will have a different value in this format.

System Configuration Screens

NOTE: See FIG. 21 for a map of the **System Configuration Screens**. Detailed screen descriptions follow.

NOTE: Each screen displays the current screen number and the total number of screens in the group.

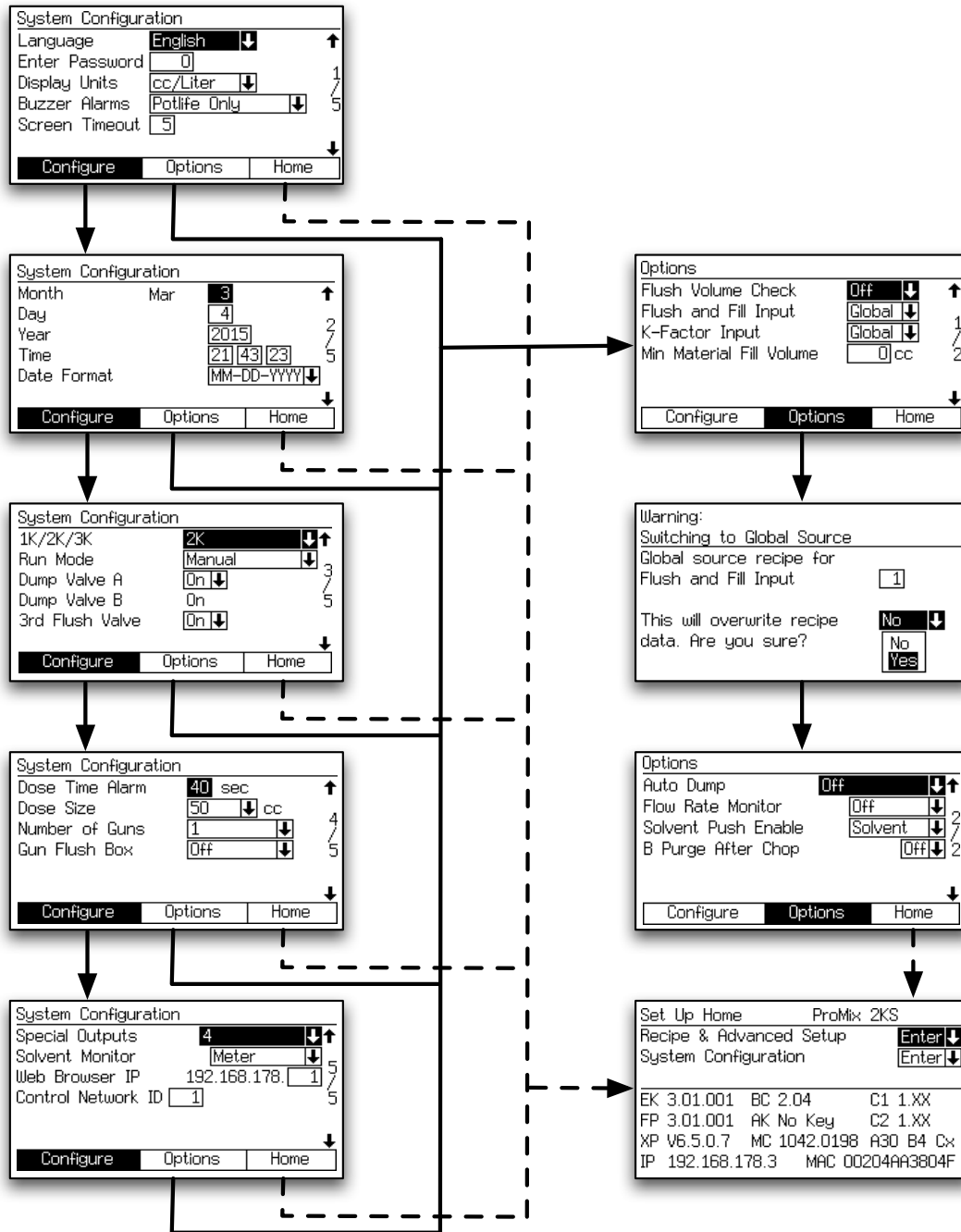

T112785a

FIG. 21. System Configuration and Option Screens Map

Configure Screen 1

System Configuration	
Language	English ↓ ↑
Enter Password	0
Display Units	cc/Liter ↓ ↑
Buzzer Alarms	Potlife Only ↓ ↑
Screen Timeout	5
<div style="display: flex; justify-content: space-around;"> Configure Options Home </div>	

FIG. 22. Configure Screen 1

Language

Defines the language of the screen text. Select English (default), Spanish, French, German, Italian, Dutch, Japanese (Kanji), Korean, Chinese (Simplified), and Custom.

NOTE: Refer to document 313386 for instructions on using the Custom Language feature to modify the screens to support undefined languages.

Password

The password is only used to enter Setup mode. The default is 0, which means no password is required to enter Setup. If a password is desired, enter a number from 1 to 9999.

NOTE: Be sure to write down the password and keep it in a secure location.

Display Units

Select the desired display units:

- cc/liter (default)
- cc/gallon

Buzzer Alarms

As the default, the alarm buzzer is set to “Potlife Only” and will sound only for the Potlife Alarm (E-2).

Set to “All Alarms” to have the buzzer sound for any alarm.

Set to “All Except Potlife” to have the buzzer sound for any alarm except a Potlife Alarm (E2). This option is not recommended unless another active method of handling the Potlife Alarm is implemented.

Screen Timeout

Select the desired screen timeout in minutes (0-99). 5 is the default.

Configure Screen 2

System Configuration	
Month	Mar 3 ↑
Day	4 ↑
Year	2015 ↑
Time	21 43 23 ↑
Date Format	MM-DD-YYYY ↓
<div style="display: flex; justify-content: space-around;"> Configure Options Home </div>	

FIG. 23. Configure Screen 2

Month

Enter current month.

Day

Enter current day.

Year

Enter current year (four digits).

Time

Enter current time in hours (24 hour clock), minutes, and seconds. Seconds are not adjustable.

Date Format

Select MM-DD-YYYY, DD-MM-YYYY, or YYYY-MM-DD.

Configure Screen 3

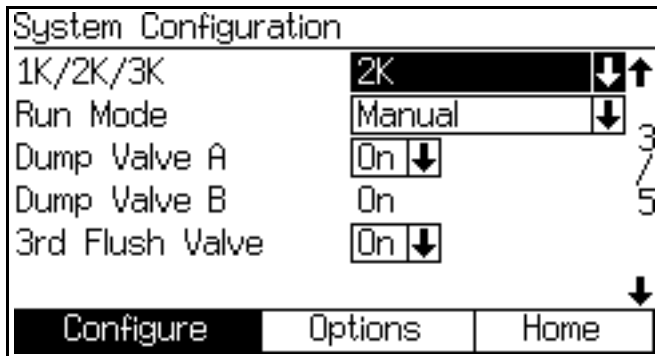

FIG. 24. Configure Screen 3

1K/2K/3K

Set this value to indicate the system performance level designation. Selecting a value other than the installed system level will result in restricted functionality.

Run Mode

NOTE: If an Autokey is installed, additional selections of Semi-Automatic and Automatic are available.

Indicates that this is a Manual system.

Dump Valve A

This field only appears if the color change option is detected from the cc board. Select "On" if an optional Dump Valve A is installed and desired to be used.

Dump Valve B

This field only appears if the catalyst change option is detected from the cc board, meaning that dump valve B is present. On is the only setting.

3rd Flush Valve

Off is default. If the system includes an optional 3rd flush valve, set to On.

Configure Screen 4

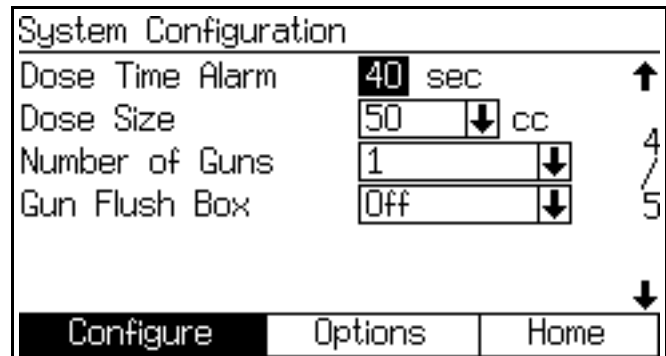

FIG. 25. Configure Screen 4

Dose Time Alarm

Enter the dose time (1 to 99 seconds). This is the amount of time allowed for a dose to occur before a dose time alarm occurs.

Dose Size

Select the total dose size (cc) from the pulldown menu: 100, 50, 25, 10, or select DD to turn on dynamic dosing (see page 50).

Example:

For a total dose size of 50 cc and a ratio of 4.0:1, the component A dose size is 40 cc and component B dose size is 10 cc.

NOTE: Increase the dose size in applications with higher flow rates or wider ratios. Decrease the dose size for a better mix under low flow conditions.

Number of Guns

Enter the number of spray guns (1 or 2).

Gun Flush Box

Enter the number of gun flush boxes (Off, 1, or 2).

NOTE: For color change and flushing purposes, it is recommended that two GFBs are installed when using a 2-gun system.

DD Setup Mode

See Fig. 26 and Fig. 27 on page 33.

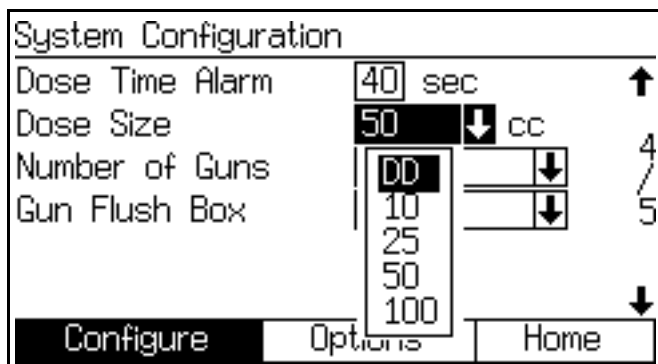

FIG. 26. Configure Screen 4, dynamic dosing selected

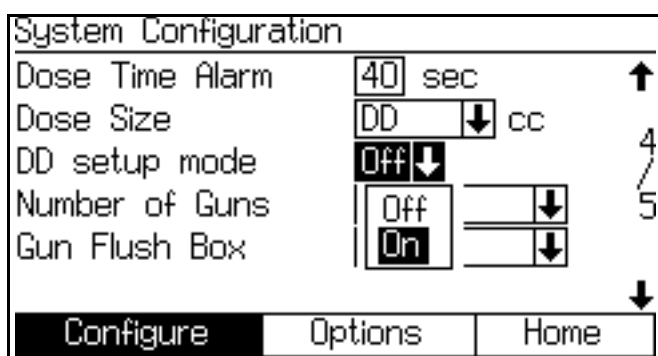

FIG. 27. Configure Screen 4, dynamic dosing setup mode enabled

DD Setup Mode

Selecting "DD" in the Dose Size field makes the Dynamic Dosing setup mode field appear. Select On to enable DD setup mode, or Off to disable. See page 51 for further information.

Configure Screen 5

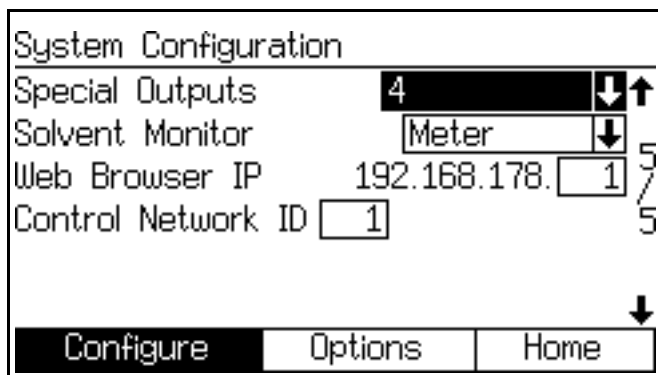

FIG. 28. Configure Screen 5

Special Outputs

Use of Special Outputs on Manual systems requires installation of a Discrete I/O Integration Board. Order Graco Part No. 15V825 Discrete I/O Integration Board Kit. See manual 406800.

NOTE: At system power up, the Special Outputs may activate for up to 1/4 second.

Select special outputs (0-4, or 3 + GFB on #4). A selection of "0" will disable use of the Special Outputs. If the "3 + GFB on #4" selection is chosen, the other 3 special outputs (1-3) can be used for user-defined functions and the special output #4 settings will duplicate those settings established for the Gun Flush Box.

Each output has two different start times and durations defined on the Recipe Setup screen (Flush and Fill Input is set to "Recipe" in **Option Screen 1**, page 34), or on the Advanced Setup screen (Flush and Fill Input is set to "Global" in **Option Screen 1**, page 34).

Solvent Monitor

Select solvent monitor (Off, Flow Switch, or Meter).

A selection of "Meter" will cause the system to track the amount of solvent used. See **Totals Screen**, page 25 for more information about solvent totals.

Web Browser IP

The default web browser IP address prefix is 192.168.178.___. Assign a unique number for each EasyKey in your system (1-99) and enter it here.

Control Network ID

Used for the Graco Gateway network system. See Graco Gateway manual 312785 for further information.

Option Screens

NOTE: See FIG. 21 on page 30 for a map of the **Option Screens**. Detailed screen descriptions follow.

NOTE: Each screen displays the current screen number and the total number of screens in the group.

Option Screen 1

Options			
Flush Volume Check	Off	↓	↑
Flush and Fill Input	Global	↓	1
K-Factor Input	Global	↓	2
Min Material Fill Volume	0	cc	

↓

Configure Options Home

FIG. 29. Option Screen 1

Flush Volume Check

This field only appears if Solvent Monitor is set to "Meter" in **Configure Screen 5**, page 33.

If set to "On", Minimum Flush Volume will appear in **Recipe Setup Screen 2**, page 41.

Flush and Fill Input

If set to "Global", Color/Catalyst Purge and Color/Catalyst Fill are added to **Advanced Setup Screen 1**, page 37. **Advanced Setup Screen 2, 3, and 5** are added. See pages 37-39.

If set to "Recipe", Color/Catalyst Purge and Color/Catalyst Fill are added to **Recipe Setup Screen 2**, page 41. **Recipe Setup Screen 3, 4, and 7** are added. See pages 42-44.

K-factor Input

Global mode is useful when the material properties, flush and fill characteristics, or K-factors are the same for all materials used by the system.

If set to "Global," **Advanced Setup Screen 4**, page 38 is added.

If set to "Recipe," **Recipe Setup Screen 5**, page 43, is added.

Minimum Material Fill Volume

Enter 0-9999 cc.

Verification Screen

Warning:	
Switching to Global Source	
Global source recipe for Flush and Fill Input	1
This will overwrite recipe data. Are you sure?	No ↓ No Yes

FIG. 30. Verification Screen

Verification

This screen appears if Flush and Fill Input or K-factor Input are changed from "Recipe" to "Global" in **Option Screen 1**.

Option Screen 2

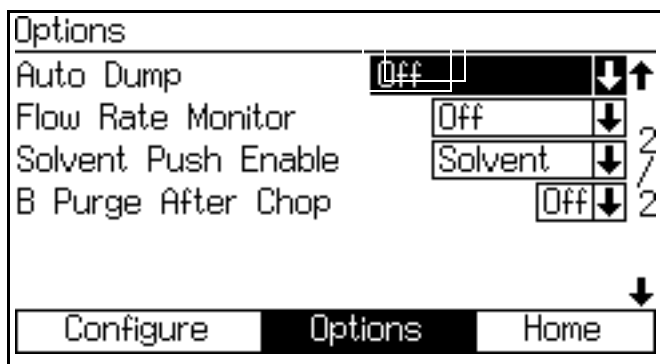

FIG. 31. Option Screen 2

Auto Dump

If the auto dump feature is being used, set to “Solvent Push” or “Mix Fill Push”. Once the auto dump is enabled, the gun flush box is enabled and the potlife alarm is active for 2 minutes, the system will automatically flush or push out the old material based on the selected option.

“Solvent Push” will flush out expired material using the solvent supply. See **Solvent Push Feature** on page 65 for more information.

“Mix Fill Push” will push out expired material with new mixed material. When sufficient material has been pushed, the potlife alarm will reset. See **Mix Fill Push Feature** on page 66 for more information.

Flow Rate Monitor

If set to “On,” **Recipe Setup Screen 6** on page 43 is added, enabling setting of high and low flow limits.

If set to “Off,” flow rate monitoring is disabled and **Recipe Setup Screen 6** on page 43 will not appear.

Solvent Push Enable

NOTE: See **Solvent Push Feature** on page 65 for more information.

To enable the Solvent Push feature, select “Solvent” or “3rd Valve” (available if 3rd Flush Valve in **Configure Screen 3**, page 32, is set to “On”).

To disable the Solvent Push feature, set to “Off.”

B Purge After Chop

NOTE: This is used to isolate the Chop cycle from the Final Purge cycle with solvent to prevent reaction issues with some types of materials.

Optional 2-second burst (2 s B) operation of the B Purge valve on the integrator after the Chop cycle.

See **Color Change Sequences**, page 69 for color change charts and timing information.

Advanced Setup Screens

NOTE: See FIG. 32 for a map of the **Advanced Setup Screens**. Detailed screen descriptions follow.

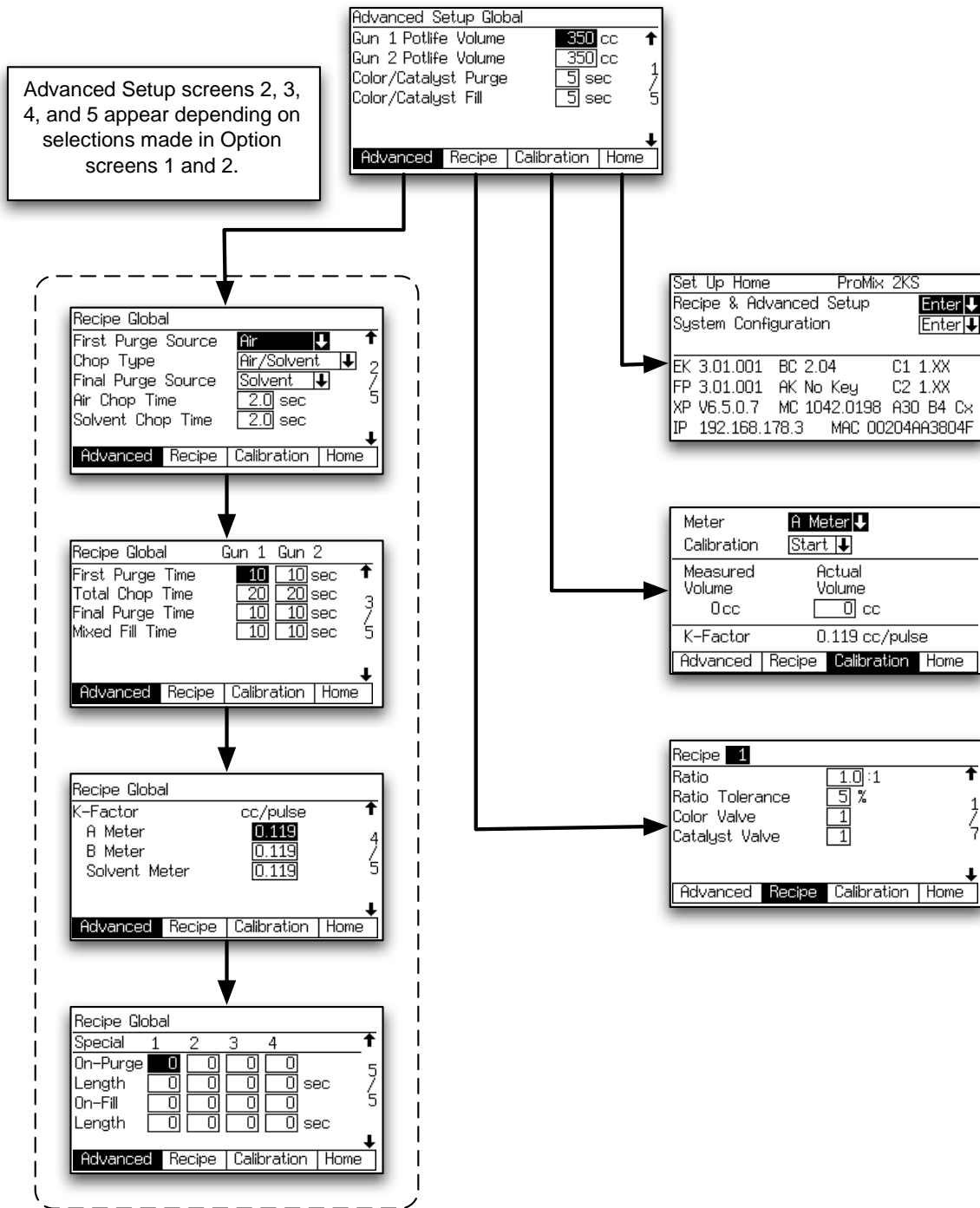

T112786a

FIG. 32. Advanced Setup Screens Map

NOTE: Each screen displays the current screen number and the total number of screens in the group. The total number of screens in a group and the fields displayed on each screen may vary depending on selections made in the **System Configuration Screens** and **Option Screens**.

Advanced Setup Screen 1

Advanced Setup Global			
Gun 1 Potlife Volume	350 cc	↑	
Gun 2 Potlife Volume	350 cc		1
Color/Catalyst Purge	5 sec		5
Color/Catalyst Fill	5 sec		
↓			
<div style="display: flex; justify-content: space-between; border: 1px solid black; padding: 2px;"> Advanced Recipe Calibration Home </div>			

FIG. 33. Advanced Setup Screen 1

Gun 1/Gun2 Potlife Volume

Enter the potlife volume (1 to 1999 cc) for each gun. This is the amount of material required to move through the mix manifold, hose and applicator/gun before the potlife timer is reset.

Use the following information to determine approximate pot life volume (PLV) in cc:

Hose ID (inches)	Volume (cc/foot)*
3/16	5.43
1/4	9.648
3/8	21.71

Integrator manifold and mixer volume = 75 cc
Spray Gun Volume = 20 cc

$(\text{Hose Volume} * \text{Feet of Hose}) + 75 + 20 = \text{PLV}$

Color/Catalyst Purge

This field only appears if the system includes a color change module and Flush and Fill Input is set to "Global" in **Option Screen 1**, page 34. Enter the purge time (0 to 99 seconds). It refers to the amount of time required to flush the lines from the color or catalyst module to the dose valve or dump valve.

Color/Catalyst Fill

This field only appears if the system includes a color change module and Flush and Fill Input is set to "Global" in **Option Screen 1**, page 34. Enter the fill time (0 to 99 seconds). It refers to the time required to fill the lines from the color or catalyst module to the dose valve or dump valve.

Advanced Setup Screen 2

Recipe Global			
First Purge Source	Air	↓	↑
Chop Type	Air/Solvent	↓	2
Final Purge Source	Solvent	↓	7
Air Chop Time	2.0 sec		5
Solvent Chop Time	2.0 sec		
↓			
<div style="display: flex; justify-content: space-between; border: 1px solid black; padding: 2px;"> Advanced Recipe Calibration Home </div>			

FIG. 34. Advanced Setup Screen 2

This screen appears only if Flush and Fill Input is set to "Global" in **Option Screen 1**, page 34.

First Purge Source

Select "Air," "Solvent," or "3rd Flush Valve" (available only if 3rd Flush Valve is set to "On" in **Configure Screen 3** on page 32).

Chop Type

Select "Air/Solvent" or "Air/3rd Flush Valve" (available only if 3rd Flush Valve is set to "On" in **Configure Screen 3** on page 32). This refers to the process of mixing air and solvent (or air and 3rd flush fluid) together during the flush cycle, to help clean the lines and reduce solvent usage.

Final Purge Source

Select "Air," "Solvent," or "3rd Flush Valve" (available only if 3rd Flush Valve is set to "On" in **Configure Screen 3** on page 32).

Air Chop Time

Enter the air chop time (0.0 to 99.9 seconds).

Solvent Chop Time/3rd Flush Valve Chop Time

Enter the solvent or 3rd flush valve chop time (0.0 to 99.9 seconds).

Advanced Setup Screen 3

Recipe Global	Gun 1	Gun 2	
First Purge Time	10	10	sec ↑
Total Chop Time	20	20	sec 3
Final Purge Time	10	10	sec /
Mixed Fill Time	10	10	sec 5 ↓
<div style="display: flex; justify-content: space-between; border-top: 1px solid black; padding-top: 5px;"> Advanced Recipe Calibration Home </div>			

FIG. 35. Advanced Setup Screen 3

This screen appears only if Flush and Fill Input is set to "Global" in **Option Screen 1**, page 34.

If Number of Guns is set to "2" in **Configure Screen 4**, page 32, a Gun 2 column will appear in this screen.

First Purge Time

Enter the first purge time (0 to 999 seconds).

Total Chop Time

Enter the total chop time (0 to 999 seconds).

Final Purge Time

Enter the final purge time (0 to 999 seconds).

Mixed Material Fill Time

Enter the mixed material fill time (0 to 999 seconds). It refers to the amount of time that is required to load mixed material from the dose valves to the applicator/gun.

Advanced Setup Screen 4

Recipe Global			
K-Factor		cc/pulse	↑
A Meter	0.119		4
B Meter	0.119		/
Solvent Meter	0.119		5 ↓
<div style="display: flex; justify-content: space-between; border-top: 1px solid black; padding-top: 5px;"> Advanced Recipe Calibration Home </div>			

FIG. 36. Advanced Setup Screen 4

This screen appears only if K-factor Input is set to "Global" in **Option Screen 1**, page 34.

K-factor A Meter

Enter the k-factor (cc/pulse) for flow meter A. This is the amount of material that passes through the flow meter per pulse (electrical pulse signal).

K-factor B Meter

Enter the k-factor (cc/pulse) for flow meter B.

K-factor Solvent Meter

This field only appears if Solvent Monitor in **Configure Screen 5**, page 33, is set to "Meter." Enter the k-factor (cc/pulse) for the solvent flow meter.

Advanced Setup Screen 5

Recipe Global						
Special	1	2	3	4	↑	
On-Purge	0	0	0	0	5 / 5 ↓	
Length	0	0	0	0		sec
On-Fill	0	0	0	0		
Length	0	0	0	0		sec
<div style="display: flex; justify-content: space-between; border-top: 1px solid black;"> Advanced Recipe Calibration Home </div>						

FIG. 37. Advanced Setup Screen 5

This screen appears only if Flush and Fill Input is set to "Global" in **Option Screen 1**, page 34 and Special Outputs is set to 1, 2, 3, or 4 in **Configure Screen 5**, page 33. The I/O board has four programmable outputs.

On-Purge

Delay time at the start of the purge cycle before the Special Output turns on.

Length

Duration for the Special Output to be active during the purge cycle.

On-Fill

Delay time at the start of the fill cycle before the Special Output turns on.

Length

Duration for the Special Output to be active during the fill cycle.

Recipe Setup Screens

NOTE: See FIG. 38 for a map of the Recipe screens. Detailed screen descriptions follow.

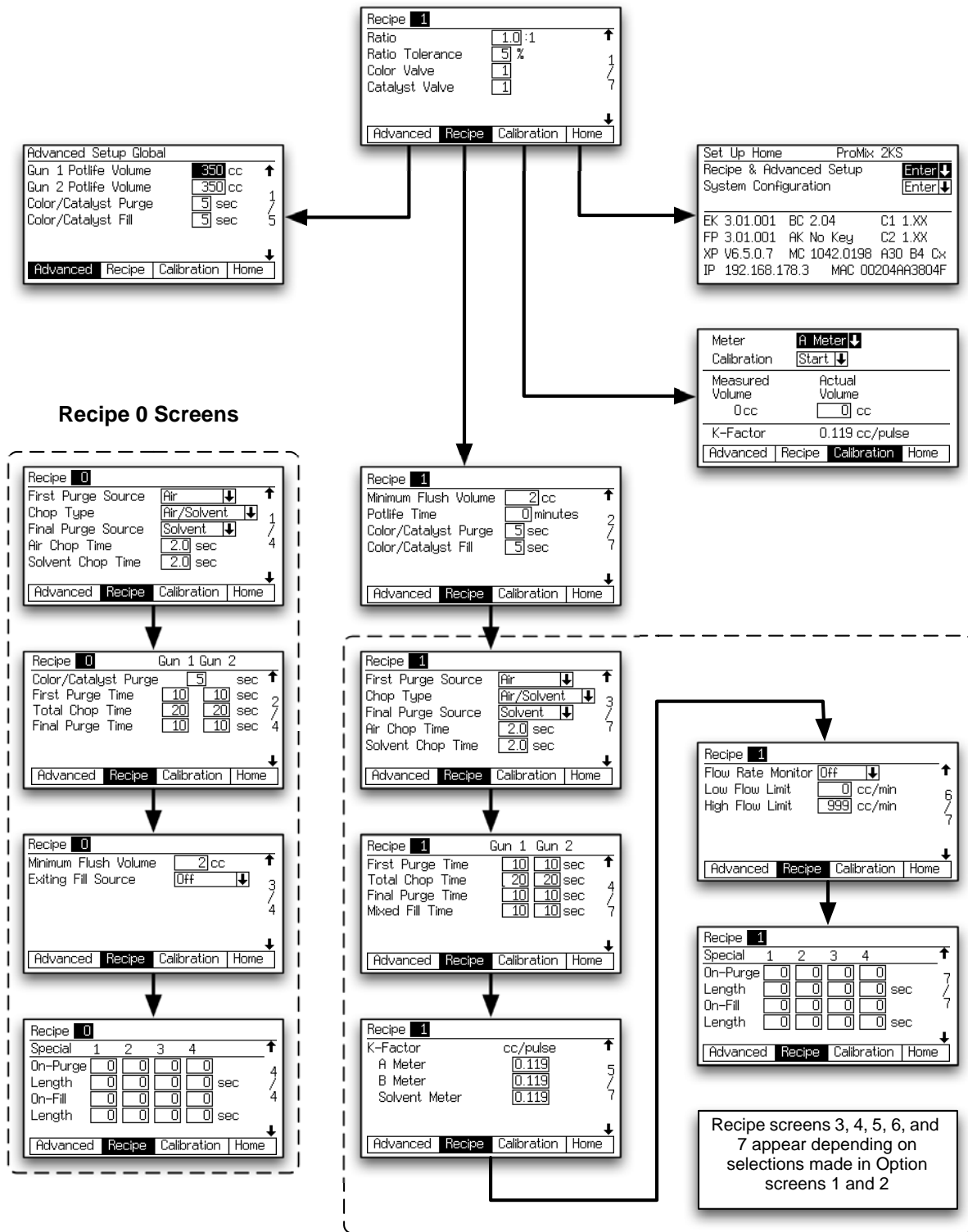

T112787a

FIG. 38: Recipe Screens Map

NOTE: Each screen displays the current screen number and the total number of screens in the group. The total number of screens in a group and the fields displayed on each screen may vary depending on selections made in the **System Configuration Screens** and **Option Screens**.

Recipe Setup Screen 1

FIG. 39. Recipe Setup Screen 1

Ratio

Enter the mix ratio of component A over component B (0.0:1 to 50:1).

Ratio Tolerance

Enter the ratio tolerance (1 to 99%). This refers to the percent of acceptable variance that the system will allow before a ratio alarm occurs.

Component A (Color) Valve (if present)

This field only appears if the system includes a color change module. Enter the color valve number (1 to 30).

Component B (Catalyst) Valve (if present)

This field only appears if the system includes a color change module. Enter the catalyst valve number (1 to 4).

Recipe Setup Screen 2

FIG. 40. Recipe Setup Screen 2

Minimum Flush Volume

This field only appears if Flush Volume Check is set to "On" in **Option Screen 1** on page 34. Enter the minimum flush volume (0 to 9999 cc). Entering 0 disables this function.

Potlife Time

Enter the potlife time (0 to 999 minutes). Entering 0 disables this function.

Color/Catalyst Purge

This field only appears if the system includes a color change module and Flush and Fill Input is set to "Recipe" in **Option Screen 1**, page 34. Enter the purge time (0 to 99 seconds). It refers to the amount of time required to flush the lines from the color or catalyst module to the dose valve or dump valve.

Color/Catalyst Fill

This field only appears if the system includes a color change module and Flush and Fill Input is set to "Recipe" in **Option Screen 1**, page 34. Enter the fill time (0 to 99 seconds). It refers to the time required to fill the lines from the color or catalyst module to the dose valve or dump valve.

Recipe Setup Screen 3

Recipe 1		
First Purge Source	Air ↓	↑
Chop Type	Air/Solvent ↓	3
Final Purge Source	Solvent ↓	7
Air Chop Time	2.0 sec	
Solvent Chop Time	2.0 sec	
Advanced Recipe Calibration Home		↓

FIG. 41. Recipe Setup Screen 3

This screen appears only if Flush and Fill Input is set to "Recipe" in **Option Screen 1**, page 34.

First Purge Source

Select "Air," "Solvent," or "3rd Flush Valve" (available only if 3rd Flush Valve is set to "On" in **Configure Screen 3** on page 32).

Chop Type

Select "Air/Solvent" or "Air/3rd Flush Valve" (available only if 3rd Flush Valve is set to "On" in **Configure Screen 3** on page 32). This refers to the process of mixing air and solvent (or air and 3rd flush fluid) together during the flush cycle, to help clean the lines and reduce solvent usage.

Final Purge Source

Select "Air," "Solvent," or "3rd Flush Valve" (available only if 3rd Flush Valve is set to "On" in **Configure Screen 3** on page 32.)

Air Chop Time

Enter the air chop time (0.0 to 99.9 seconds).

Solvent Chop Time/3rd Flush Valve Chop Time

Enter the solvent or 3rd flush valve chop time (0.0 to 99.9 seconds).

Recipe Setup Screen 4

Recipe 1	Gun 1	Gun 2	
First Purge Time	10	10	sec ↑
Total Chop Time	20	20	sec 4
Final Purge Time	10	10	sec 7
Mixed Fill Time	10	10	sec 7
Advanced Recipe Calibration Home			↓

FIG. 42. Recipe Setup Screen 4

This screen appears only if Flush and Fill Input is set to "Recipe" in **Option Screen 1**, page 34.

If Number of Guns is set to "2" in **Configure Screen 4**, page 32, a Gun 2 column will appear in this screen.

First Purge Time

Enter the first purge time (0 to 999 seconds).

Total Chop Time

Enter the total chop time (0 to 999 seconds).

Final Purge Time

Enter the final purge time (0 to 999 seconds).

Mixed Material Fill Time

Enter the mixed material fill time (0 to 999 seconds). It refers to the amount of time that is required to load mixed material from the dose valves to the applicator/gun.

Recipe Setup Screen 5

Recipe 1		
K-Factor	cc/pulse	↑
A Meter	<input type="text" value="0.119"/>	5
B Meter	<input type="text" value="0.119"/>	/
Solvent Meter	<input type="text" value="0.119"/>	7
		↓
Advanced	Recipe	Calibration Home

FIG. 43. Recipe Setup Screen 5

This screen appears only if K-factor Input is set to "Recipe" in **Option Screen 1**, page 34.

K-factor A Meter

Enter the k-factor (cc/pulse) for flow meter A. This is the amount of material that passes through the flow meter per pulse (electrical pulse signal).

K-factor B Meter

Enter the k-factor (cc/pulse) for flow meter B.

K-factor Solvent Meter

This field only appears if Solvent Monitor in **Configure Screen 5**, page 33, is set to "Meter." Enter the k-factor (cc/pulse) for the solvent flow meter.

Recipe Setup Screen 6

Recipe 1		
Flow Rate Monitor	<input type="text" value="Off"/>	↓ ↑
Low Flow Limit	<input type="text" value="0"/> cc/min	6
High Flow Limit	<input type="text" value="999"/> cc/min	/
		7
		↓
Advanced	Recipe	Calibration Home

FIG. 44. Recipe Setup Screen 6

This screen appears only if Flow Rate Monitor is set to "On" in **Option Screen 2** on page 35.

Flow Rate Monitor

Select the desired flow rate monitoring (Off, Warning, or Alarm).

Low Flow Limit

Enter the low flow rate limit (1 to 3999 cc/min).

High Flow Limit

Enter the high flow rate limit (1 to 3999 cc/min).

Recipe Setup Screen 7

Recipe 1	1	2	3	4	
Special					↑
On-Purge	<input type="text" value="0"/>	<input type="text" value="0"/>	<input type="text" value="0"/>	<input type="text" value="0"/>	7 / 7
Length	<input type="text" value="0"/>	<input type="text" value="0"/>	<input type="text" value="0"/>	<input type="text" value="0"/>	
On-Fill	<input type="text" value="0"/>	<input type="text" value="0"/>	<input type="text" value="0"/>	<input type="text" value="0"/>	↓
Length	<input type="text" value="0"/>	<input type="text" value="0"/>	<input type="text" value="0"/>	<input type="text" value="0"/>	
<div style="display: flex; justify-content: space-between; border: 1px solid black; padding: 2px;"> Advanced Recipe Calibration Home </div>					

FIG. 45. Recipe Screen 7

This screen appears only if Flush and Fill Input is set to "Recipe" in **Option Screen 1**, page 34 and Special Outputs is set to 1, 2, 3, 4, or "3 + GFB on #4" in **Configure Screen 5**, page 33. The I/O board has four programmable outputs.

NOTE: If the Special Outputs is set to "3 + GFB on #4", the Recipe 0 Screen 4 does not display the column of information for Special 4. That Output assumes the values assigned to GFB #1.

On-Purge

Delay time at the start of the purge cycle before the Special Output turns on.

Length

Duration for the Special Output to be active during the purge cycle.

On-Fill

Delay time at the start of the fill cycle before the Special Output turns on.

Length

Duration for the Special Output to be active during the fill cycle.

Recipe 0 Screens

NOTE: See FIG. 38 on page 40 for a map of the Recipe 0 screens. Detailed screen descriptions follow.

Recipe 0 is typically used:

- in multiple color systems to purge out material lines without loading a new color
- at the end of a shift to prevent hardening of catalyzed material.

NOTE: Each screen displays the current screen number and the total number of screens in the group. The total number of screens in a group and the fields displayed on each screen may vary depending on selections made in the **System Configuration Screens** and **Option Screens**.

Recipe 0 Screen 1

Recipe 0			
First Purge Source	Air	↓	↑
Chop Type	Air/Solvent	↓	1
Final Purge Source	Solvent	↓	/
Air Chop Time	2.0	sec	4
Solvent Chop Time	2.0	sec	
Advanced		Recipe	Calibration
Home			

FIG. 46. Recipe 0 Screen 1

First Purge Source

Select "Air," "Solvent," or "3rd Flush Valve" (available only if 3rd Flush Valve is set to "On" in **Configure Screen 3** on page 32).

Chop Type

Select "Air/Solvent" or "Air/3rd Flush Valve" (available only if 3rd Flush Valve is set to "On" in **Configure Screen 3** on page 32). This refers to the process of mixing air and solvent (or air and 3rd flush fluid) together during the flush cycle, to help clean the lines and reduce solvent usage.

Final Purge Source

Select "Air," "Solvent," or "3rd Flush Valve" (available only if 3rd Flush Valve is set to "On" in **Configure Screen 3** on page 32.)

Air Chop Time

Enter the air chop time (0.0 to 99.9 seconds).

Solvent Chop Time/3rd Flush Valve Chop Time

Enter the solvent or 3rd flush valve chop time (0.0 to 99.9 seconds).

Recipe 0 Screen 2

Recipe 0		Gun 1	Gun 2	
Color/Catalyst Purge	5			sec ↑
First Purge Time	10	10		sec 2
Total Chop Time	20	20		sec /
Final Purge Time	10	10		sec 4
↓				
Advanced		Recipe	Calibration	Home

FIG. 47. Recipe 0 Screen 2

If Number of Guns is set to "2" in **Configure Screen 4**, page 32, a Gun 2 column will appear in this screen.

Color/Catalyst Purge Time

This field only appears if the system includes a color change module. It refers to the amount of time required to flush the lines from the color or catalyst module to the dose valve or dump valve. Enter the purge time (0 to 999 seconds).

First Purge Time

Enter the first purge time (0 to 999 seconds).

Total Chop Time

Enter the total chop time (0 to 999 seconds).

Final Purge Time

Enter the final purge time (0 to 999 seconds).

Recipe 0 Screen 3

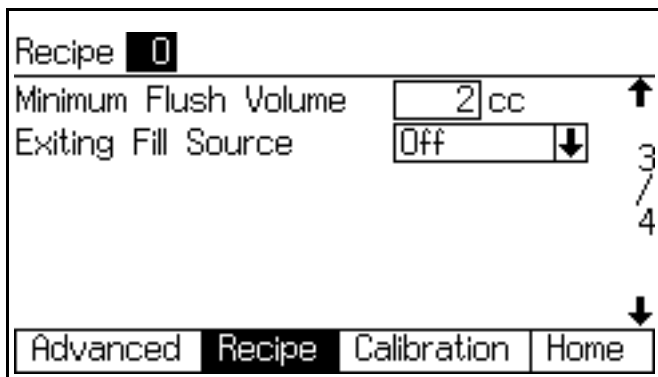

FIG. 48. Recipe 0 Screen 3

This screen only appears if Solvent Monitor is set to "Meter" in **Configure Screen 5**, page 33 and Flush Volume Check is set to "On" in **Option Screen 1**, page 34 or 3rd Flush Valve is set to "On" in **Configure Screen 3** on page 32.

Minimum Flush Volume

This field only appears if Flush Volume Check is set to "On" in **Option Screen 1** on page 34. Enter the minimum flush volume (0 to 9999 cc).

Exiting Fill Source

This field only appears if 3rd Flush Valve is set to "On" in **Configure Screen 3** on page 32. Select "Off," "Air," "Solvent," or "3rd Valve."

Recipe 0 Screen 4

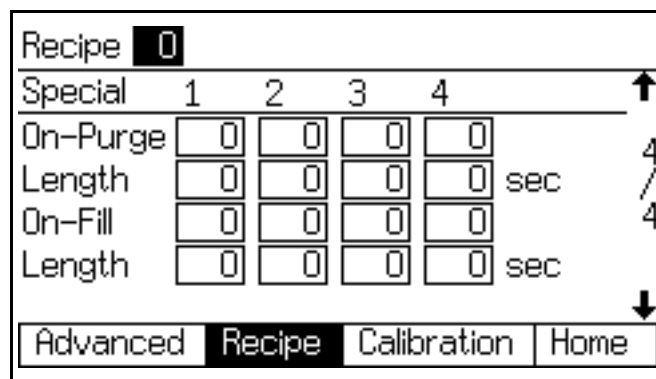

FIG. 49. Recipe 0 Screen 4

This screen appears only if Flush and Fill Input is set to "Recipe" in **Option Screen 1**, page 34 and Special Outputs is set to 1, 2, 3, 4, or "3 + GFB on #4" in **Configure Screen 5**, page 33. The I/O board has four programmable outputs.

NOTE: If the Special Outputs is set to "3 + GFB on #4", the Recipe 0 Screen 4 does not display the column of information for Special 4. That Output assumes the values assigned to GFB #1.

On-Purge

Delay time at the start of the purge cycle before the Special Output turns on.

Length

Duration for the Special Output to be active during the purge cycle.

On-Fill

Delay time at the start of the fill cycle before the Special Output turns on.

Length

Duration for the Special Output to be active during the fill cycle.

Calibration Screen

Meter	A Meter ↓
Calibration	Start ↓
Measured Volume	Actual Volume
0 cc	<input type="text" value="0"/> cc
K-Factor	0.119 cc/pulse
Advanced	Recipe
Calibration	Home

FIG. 50. Calibration Screen

Use this screen to calibrate a meter. Set to "A Meter," "B Meter," or "Solvent Meter" (available if Solvent Monitor in **Configure Screen 5**, page 33, is set to "Meter").

- **Start** - start calibration
- **Abort** - stop calibration
- **Purge** - purge sampling valves after calibration

See **Meter Calibration**, page 67, for when and how to calibrate a meter.

System Operation

Operation Modes



System mixes and dispenses material.



Stops the system.



Purges the system, using air and solvent.

Sequential Dosing

Components A and B dispense sequentially in the necessary volumes to attain the mix ratio.

Dynamic Dosing

In typical operation (ratios 1:1 and above), component A dispenses constantly. Component B dispenses intermittently in the necessary volume to attain the mix ratio.

Recipe (Color) Change

The process when the system automatically flushes out the old color and loads a new color.

Solvent Push

The Solvent Push feature enables the user to save some mixed material by pushing it out to the gun with solvent. The feature requires an accessory solvent meter. See page 65 for complete information.

Mix Fill Push

The Mix Fill Push feature enables the user to prevent potlife expiration of material by mixing and flowing new material through the Gun Flush Box. See page 66 for complete information.

General Operating Cycle, Sequential Dosing

1. The spray gun operator enters and loads the desired recipe. The color change LED blinks while recipe is loading, then turns solid when complete.
2. The operator presses the Mix  key to begin operation.
3. The ProMix 2KS controller sends signals to activate the solenoid valves. The solenoid valves activate Dose Valves A and B. Fluid flow begins when the gun is triggered.
4. Components A and B are introduced into the fluid integrator (FI) one at a time as follows.
 - a. Dose Valve A (DVA) opens, and fluid flows into the integrator.
 - b. Flow Meter A (MA) monitors the fluid volume dispensed and sends electrical pulses to the ProMix 2KS controller. The controller monitors these pulses and signals.
 - c. When the target volume dispenses, Dose Valve A closes.

NOTE: The dispense volume of component A and B is based on the mix ratio and dose size set by the user and calculated by the ProMix 2KS controller.

- d. Dose Valve B (DVB) opens, and fluid flows into the integrator and is aligned proportionately with component A.
- e. Flow Meter B (MB) monitors the fluid volume dispensed and sends electrical pulses to the ProMix 2KS controller.
- f. When the target volume is dispensed, Dose Valve B closes.

- The components are pre-mixed in the integrator, then uniformly blended in the static mixer (SM).

NOTE: To control output from the static mixer to the gun, install an optional fluid pressure regulator.

- Components A and B are alternately fed into the integrator as long as the gun is triggered.

- If the gun is not triggered for two minutes, the system switches to Idle mode, which closes off the mix manifold dose valves.

- When the gun is triggered again, the ProMix 2KS continues the process where it left off.

NOTE: Operation can be stopped at any time by pressing the Standby  key or shutting off the main power switch.

Table 5: Sequential Dosing Operation

Ratio = 2.0:1	Dose 1		Dose 2		Dose 3	
A = 2						
B = 1						

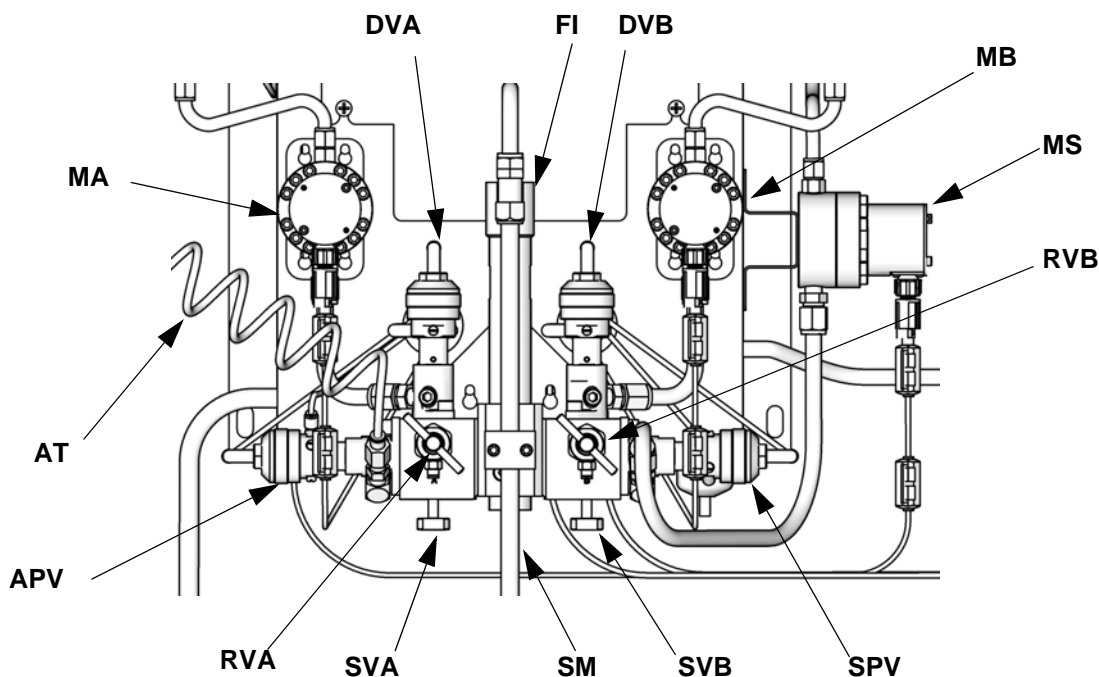

TI12556b

Key:

- | | | | |
|-----|----------------------------|-----|---------------------------------|
| MA | Component A Meter | SVB | Component B Shutoff Valve |
| DVA | Component A Dose Valve | MS | Solvent Meter (accessory) |
| RVA | Component A Sampling Valve | SPV | Solvent Purge Valve |
| SVA | Component A Shutoff Valve | APV | Air Purge Valve |
| MB | Component B Meter | SM | Static Mixer |
| DVB | Component B Dose Valve | FI | Fluid Integrator |
| RVB | Component B Sampling Valve | AT | Air Purge Valve Air Supply Tube |

FIG. 51. Wall Mount Fluid Station, Sequential Dosing

General Operating Cycle, Dynamic Dosing

Overview

Dynamic Dosing provides on-demand proportioning, eliminating the need for an integrator and therefore minimizing undesired material contact. This feature is especially useful with shear-sensitive and waterborne materials.

A restrictor injects component B into a continuous stream of component A. The software controls the duration and frequency of each injection. See FIG. 52 for a schematic diagram of the process.

Dynamic Dosing System Parameters

The following parameters affect dynamic dosing performance:

- **Component A Flow:** Ensure that the supply pump is sized to provide sufficient and uninterrupted flow. Note that component A provides majority of system flow at higher mix ratios.
- **Component B Flow:** Ensure that the supply pump is sized to provide sufficient and uninterrupted flow.
- **Component A Pressure:** Ensure precise pressure regulation. It is recommended that the component A pressure be 5-15% **lower** than the component B pressure.
- **Component B Pressure:** Ensure precise pressure regulation. It is recommended that the component B pressure be 5-15% **higher** than the component A pressure.

NOTE: When using dynamic dosing it is very important to maintain a constant, well-regulated fluid supply. To obtain proper pressure control and minimize pump pulsation, install a fluid regulator on the A and B supply lines upstream of the meters. In systems with color change, install the regulator downstream of the color/catalyst valve stack.

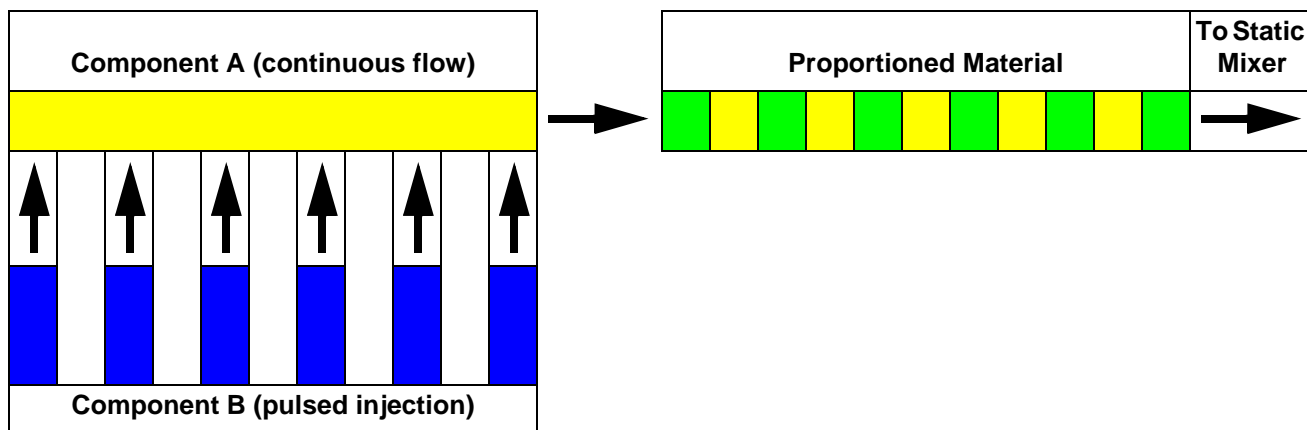



FIG. 52. Schematic Diagram of Dynamic Dosing Operation

Select a Component B Restrictor Size

Install the 15U955 Injection Kit in the fluid manifold as explained in the ProMix 2KS Installation manual. Use the charts provided in that manual to select an appropriate restrictor size based on the desired flow and mix ratio.

Turn On Dynamic Dosing

1. On the EasyKey press the Setup  key to access the Set Up Home screen. Select "System Configuration" to access the configuration screens. FIG. 53.

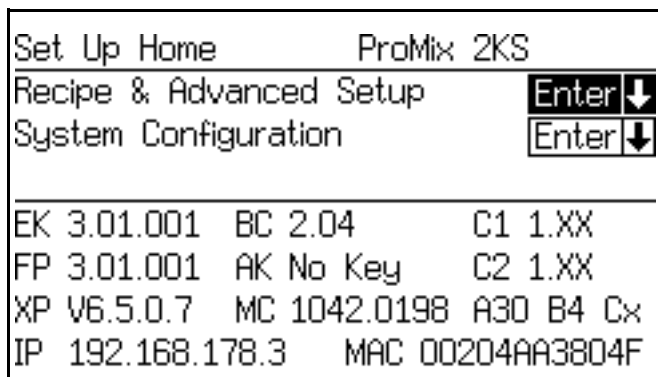

FIG. 53. Set Up Home Screen

2. Navigate to System Configure Screen 4. Select "DD" option from the "Dose Size" drop down menu. FIG. 54.

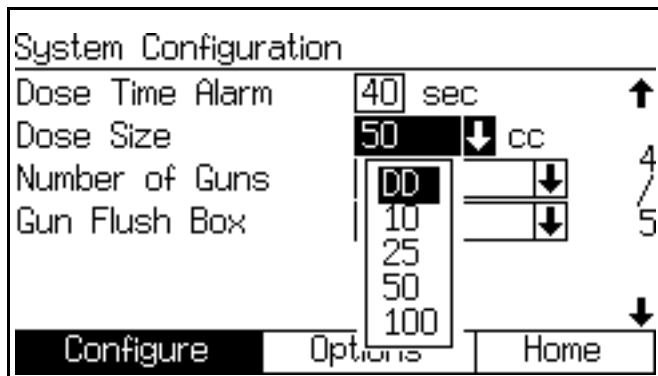

FIG. 54. Configure Screen 4, dynamic dosing selected

3. Selecting "DD" in System Configure Screen 4 makes the DD Setup mode available. See FIG. 55. To enable DD setup mode, select On in the DD setup mode drop down menu. This disables Off Ratio alarms E-3 and E-4, allowing uninterrupted setup and tuning.

NOTE: Do not use the material mixed when in DD setup mode, as it may not be on ratio due to the disabled alarms.

NOTE: If DD setup mode is not turned Off at the end of setup, it will automatically turn off 3 minutes after initiation of a Mix command.

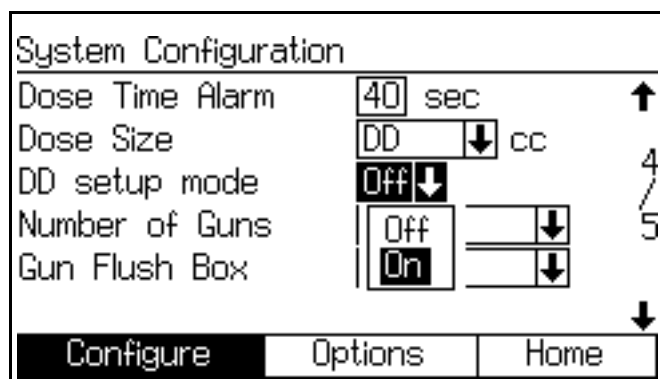

FIG. 55. Configure Screen 4, dynamic dosing setup mode enabled

Balancing A/B Pressure

If component B pressure is too high, it will push the component A stream aside during B injection. The valve will not open long enough, causing a High Ratio alarm.

If component B pressure is too low, it will not be injected in sufficient volume. The valve will stay open too long, causing a Low Ratio alarm.

Selecting the correct component B restrictor size and balancing the A/B pressures will keep the system in the proper pressure range, resulting in a consistent mix ratio.

FIG. 57 shows the A to B pressure balance, read at the proportioner inlet. It is recommended that the component B pressure be 5-15% higher than the component A pressure to keep the system in the control range, hold the proper mix ratio, and obtain properly mixed material. If pressures are not balanced (“B Pressure Too High” or “B Pressure Too Low”), it may not be possible to hold the desired mix ratio. The system will generate an off ratio alarm and stop operation.

NOTE: In multi-flow rate systems, it is recommended that you set up the system to run properly at the highest flow rate, to ensure adequate fluid supply across the flow rate range.

In dynamic dosing, component A dose valve is constantly on. Component B dose valve will cycle on and off; one cycle every 0.5 – 1.0 seconds indicates proper balance.

Monitor system performance by watching the EasyKey display for warning messages which provide information on system performance, and adjust pressures accordingly. See Table 6 on page 53.

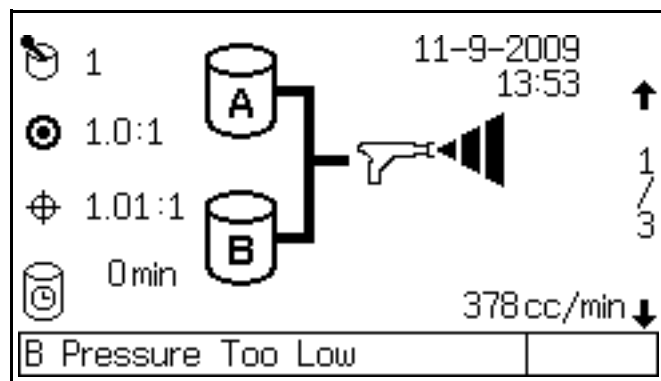

FIG. 56. B Pressure Too Low, displayed on EasyKey

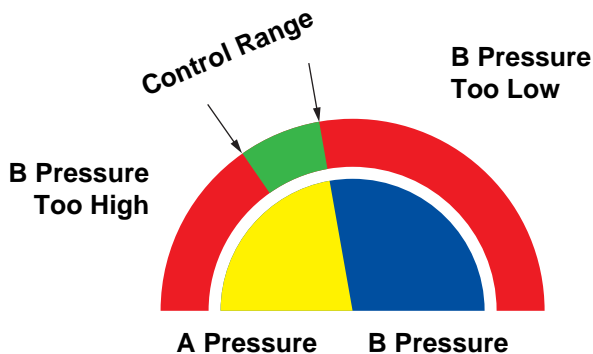
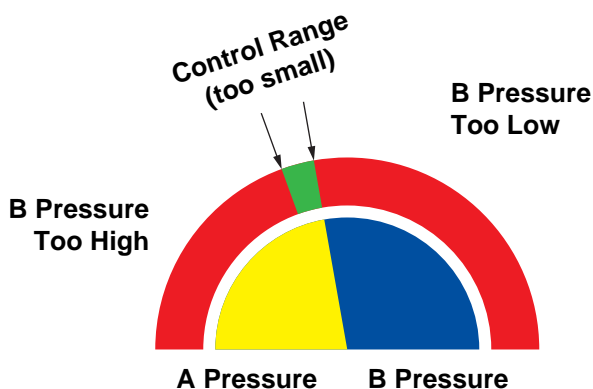

FIG. 57. A/B Control Range with Properly Sized Restrictor



NOTE: If the restrictor is too small, it may be necessary to supply more differential pressure than is available in your system.

FIG. 58. A/B Control Range with Too Large a Restrictor

Table 6: Dynamic Dosing Troubleshooting Guide
(for complete system troubleshooting, see Table 11 beginning on page 83)

Warning/Alarm Message	Solution
B Pressure Too Low (see FIG. 56)	<ul style="list-style-type: none"> • Increase B pressure. • Clean restrictor or use a larger size. • Verify B valve is opening properly.
B Pressure Too High	<ul style="list-style-type: none"> • Increase A pressure or decrease B pressure. • Use a smaller restrictor.
Off Ratio Low	<ul style="list-style-type: none"> • Increase A pressure or decrease B pressure. • Use a smaller restrictor.
Off Ratio High	<ul style="list-style-type: none"> • Increase B pressure. • Clean restrictor or use a larger size. • Verify B valve is opening properly.

Mix Manifold Valve Settings

To open dose or purge valves, turn hex nut (E) *counter-clockwise*. To close, turn *clockwise*. See Table 7 and FIG. 59.

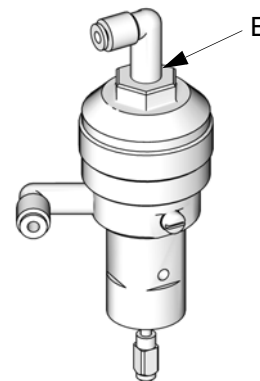

TI11581a

FIG. 59. Valve Adjustment

Table 7: Mix Manifold Valve Settings

Valve	Setting	Function
Dose (FIG. 59)	Hex nut (E) 1-1/4 turns out from fully closed	Limits maximum fluid flow rate into integrator and minimizes valve response time.
Purge (FIG. 59)	Hex nut (E) 1-1/4 turns out from fully closed	Limits maximum fluid flow rate into integrator and minimizes valve response time.
Shutoff (SVA and SVB, FIG. 67)	Fully open during Run/Mix operation	Closes component A and B ports to integrator during ratio check or meter calibration. Open ports during Run/Mix operation.
Sampling (RVA and RVB, FIG. 67)	Fully closed during Run/Mix operation	Open to dispense component A and B while calibrating meters. Do not open sampling valves unless fluid shutoff valves are closed.

Air Flow Switch (AFS) Function

Air or Air-assisted Guns

The air flow switch (AFS) detects air flow to the gun and signals the ProMix controller when the gun is triggered. The AFS functions with the flow meters to ensure that system components are functioning correctly.

For example, if a flow meter fails or clogs, pure resin or catalyst could spray indefinitely if the ProMix does not detect the condition and intervene, which is why the AFS is so important.

If the ProMix detects through the AFS signal that the gun is triggered, yet there is no fluid flow through the meter, a Dose Time Alarm (E-7 or E-8) occurs after 40 seconds and the system shuts down.

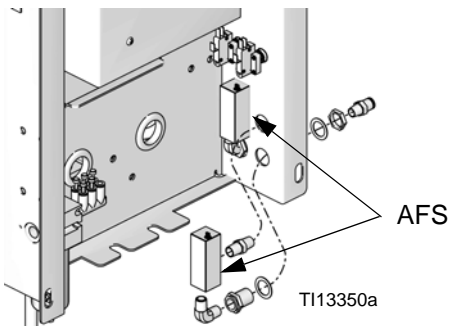

FIG. 60: Air Flow Switches

Operating Without Air Flow Switch

It is **not recommended** to run without an air flow switch. If a switch fails, replace it as soon as possible.

Airless Gun

It is **not recommended** to use an airless gun with the ProMix 2KS. Two issues can arise from operating without an air flow switch:

- Without a gun trigger/air flow switch input the ProMix 2KS does not know it is spraying and will not generate a Dose Time Alarm (E-7 or E-8). This means there is no way to detect a failed meter. You could spray pure resin or catalyst for 2 minutes without knowing.
- Since the ProMix 2KS does not know it is spraying because there is no gun trigger/air flow switch input, it will go into System Idle (E-15) every 2 minutes when in Mix mode.

System Idle Warning (E-15)

This warning occurs if the ProMix is set to Mix , and 2 minutes have elapsed since the system received a flow meter pulse.

In applications using the AFS, triggering the gun clears the warning and you can start spraying again.

Without the AFS, triggering the gun does not clear the alarm. To start spraying again, you must press Standby

, then Mix , then trigger the gun.

Start Up

1. Go through the Pre-Operation Checklist in Table 8.

Table 8: Pre-Operation Checklist

✓	Checklist
	<p>System grounded</p> <p>Verify all grounding connections were made. See the Installation manual.</p>
	<p>All connections tight and correct</p> <p>Verify all electrical, fluid, air, and system connections are tight and installed according to the Installation manual.</p>
	<p>Check air purge valve tubing</p> <p>Check the air purge valve supply tube daily for any visible solvent accumulation. Notify your supervisor if solvent is present.</p>
	<p>Fluid supply containers filled</p> <p>Check component A and B and solvent supply containers.</p>
	<p>Mix manifold valves set</p> <p>Check that mix manifold valves are set correctly. Start with the settings recommended in Mix Manifold Valve Settings, page 53, then adjust as needed.</p>
	<p>Fluid supply valves open and pressure set</p> <p>Component A and B fluid supply pressures should be equal unless one component is more viscous and requires a higher pressure setting.</p>
	<p>Solenoid pressure set</p> <p>75-100 psi inlet air supply (0.5-0.7 MPa, 5.2-7 bar)</p>

2. Turn the AC Power Switch ON (I = ON, 0 = OFF).

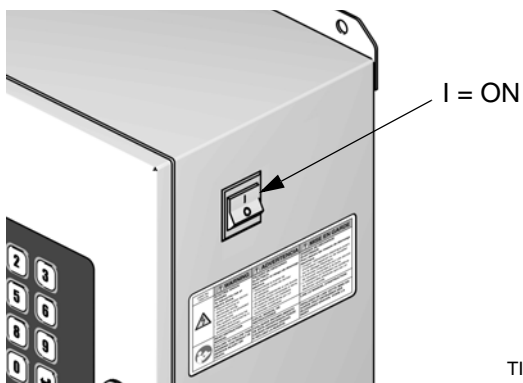

Fig. 61. Power Switch

- Graco logo, software revision, and “Establishing Communication” will display, followed by Status screen. See page 22.
- At power up the system defaults to Recipe 61, which is not a valid recipe number. Initiate a color change to Recipe 0 or a valid recipe number (1-60).
- In bottom left corner, the system status displays, which can be Standby, Mix, Purge, or an alarm notification

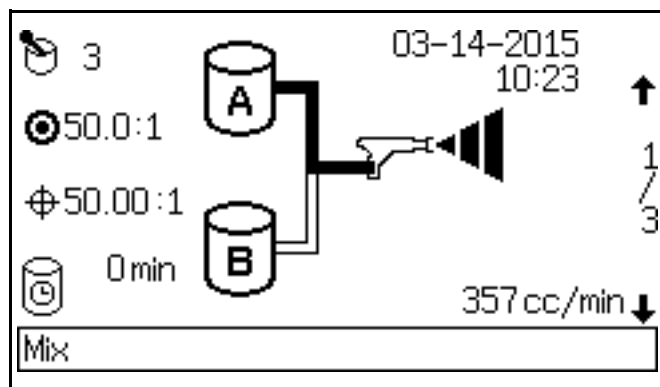



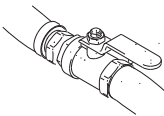



Fig. 62. Status Screen

3. Make sure that the Booth Control is working. The active recipe number should display and the Standby LED  should be lit.
4. If this is the first time starting up the system, purge it as instructed in **Purging Fluid Supply System**, page 62. The equipment was tested with lightweight oil, which should be flushed out to avoid contaminating your material.
5. Make sure that the Booth Control is in Standby  mode.

6. Adjust component A and B fluid supplies as needed for your application. Use lowest pressure possible. 
7. Do not exceed the maximum rated working pressure shown on the system identification label or the lowest rated component in the system.
8. Open the fluid supply valves to the system. 
9. Adjust the air pressure. Most applications require about 80 psi (552 kPa, 5.5 bar) air pressure to operate properly. Do not use less than 75 psi (517 kPa, 5.2 bar).
10. If using a gun flush box, place the gun into the box

and close the lid. Press the Purge  key on the Booth Control. The purge sequence automatically starts.

If the gun flush box is not used, trigger the gun into a grounded metal pail until the purge sequence is complete. 

When done purging, the Booth Control automatically switches to Standby mode.

11. Adjust the flow rate.

The fluid flow rate shown on the EasyKey Status screen is for either component A or B, depending on which dose valve is open. The fluid supply lines on the screen highlight to show which dose valve is open.

Watch the fluid flow rate displayed on the Status screen while the gun is fully open. Verify that the flow rate of components A and B are within 10% of each other.

If the fluid flow rate is too low: increase air pressure to component A and B fluid supplies or increase the regulated fluid pressure.

If the fluid flow rate is too high: reduce the air pressure, close the fluid manifold dose valves further, or adjust the fluid pressure regulator.

NOTE: Pressure adjustments of each component will vary with fluid viscosity. Start with the same fluid pressure for component A and B, then adjust as needed.

NOTE: Do not use the first 4-5 oz. (120-150 cc) of material as it may not be thoroughly mixed due to alarms while priming the system.

12. Turn on atomizing air to the gun. Check the spray pattern as instructed in your spray gun manual.

NOTE: Do not allow a fluid supply tank to run empty. It is possible for air flow in the supply line to turn gear meters in the same manner as fluid. This can lead to the proportioning of fluid and air that meets the ratio and tolerance settings of the equipment. This can further result in spraying uncatalyzed or poorly catalyzed material.

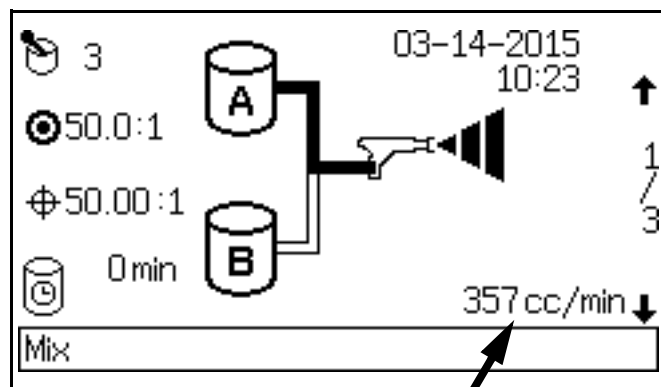

FIG. 63. Status Screen Flow Rate Display

Shutdown

Overnight Shutdown

1. Leave the power on.
2. Run Recipe 0 to purge solvent through meters and gun.

Service Shutdown

1. Follow **Pressure Relief Procedure** on page 57.
2. Close main air shutoff valve on air supply line and on ProMix.
3. Shut off ProMix 2KS power (0 position). FIG. 64.
4. If servicing EasyKey, also shut off power at main circuit breaker.

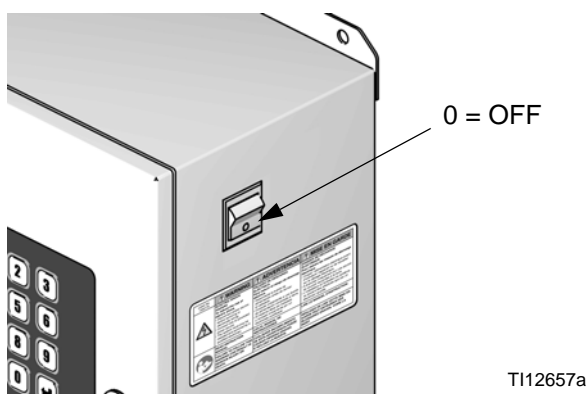
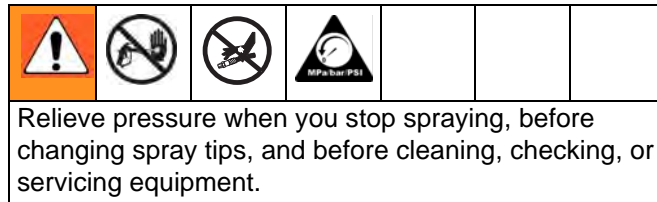

FIG. 64. Power Switch

Pressure Relief Procedure

NOTE: The following procedures relieve all fluid and air pressure in the ProMix 2KS system. Use the procedure appropriate for your system configuration.



Single Color Systems

1. While in Mix mode (gun triggered), shut off the A and B fluid supply pumps/pressure pots. Close all fluid shutoff valves at the pump outlets.
2. With the gun triggered, push the manual override on the A and B dose valve solenoids to relieve pressure. See FIG. 65.

NOTE: If a Dose Time alarm (E-7, E-8) occurs, clear the alarm.

3. Do a complete system purge, following the instructions under **Purging Using Recipe 0**, page 62.
4. Shut off the fluid supply to the solvent purge valve (SPV) and the air supply to the air purge valve (APV), FIG. 67.
5. With the gun triggered, push the manual override on the A and B purge valve solenoids to relieve air and solvent pressure. See FIG. 65. Verify that solvent pressure is reduced to 0.

NOTE: If a Purge Volume alarm (E-11) occurs, clear the alarm.

Systems with Color Change and without Dump Valves

NOTE: This procedure relieves pressure through the sampling valve.

1. Complete all steps under **Single Color Systems**, page 57.
2. Close the A side shutoff valve (SVA), FIG. 67. Open the A side sampling valve (RVA).
3. Direct the A side sampling tube into a waste container.
4. See FIG. 66. Open the color change module. Using the solenoid identification labels as a guide, press and hold the override button on each color solenoid until flow from the sampling valve stops.
5. Press and hold the solvent solenoid override until clean solvent comes from the sampling valve, then release.
6. Shutoff the solvent supply to the color change stack solvent valve.
7. Press and hold the solvent solenoid override until solvent flow from the sampling valve stops.
8. Open the A side shutoff valve (SVA), FIG. 67. Close the A side sampling valve (RVA).

Systems with Color/Catalyst Change and Dump Valves

NOTE: This procedure relieves pressure through the dump valves.

1. Complete all steps under **Single Color Systems**, page 57.
2. Shut off all color and catalyst supplies to the valve stacks.
3. Press and hold the dump valve A solenoid override, FIG. 65.
4. See FIG. 66. Open the color change module. Using the solenoid identification labels as a guide, press and hold the override button on each color solenoid until flow from dump valve A stops.
5. Press and hold the dump valve B solenoid override, FIG. 65.
6. See FIG. 66. Using the solenoid identification labels as a guide, press and hold the override button on each catalyst solenoid until flow from dump valve B stops.
7. Press and hold the dump valve A solenoid override, FIG. 65.
8. Press and hold the A side (color) solvent solenoid override until clean solvent comes from the dump valve, then release.
9. Press and hold the dump valve B solenoid override, FIG. 65.
10. Press and hold the B side (catalyst) solvent solenoid override until clean solvent comes from the dump valve, then release.
11. Shutoff the solvent supply to the color/catalyst change stack solvent valves.
12. Press and hold the A and B solvent solenoid overrides and dump valve overrides until solvent flow from the dump valves stops.

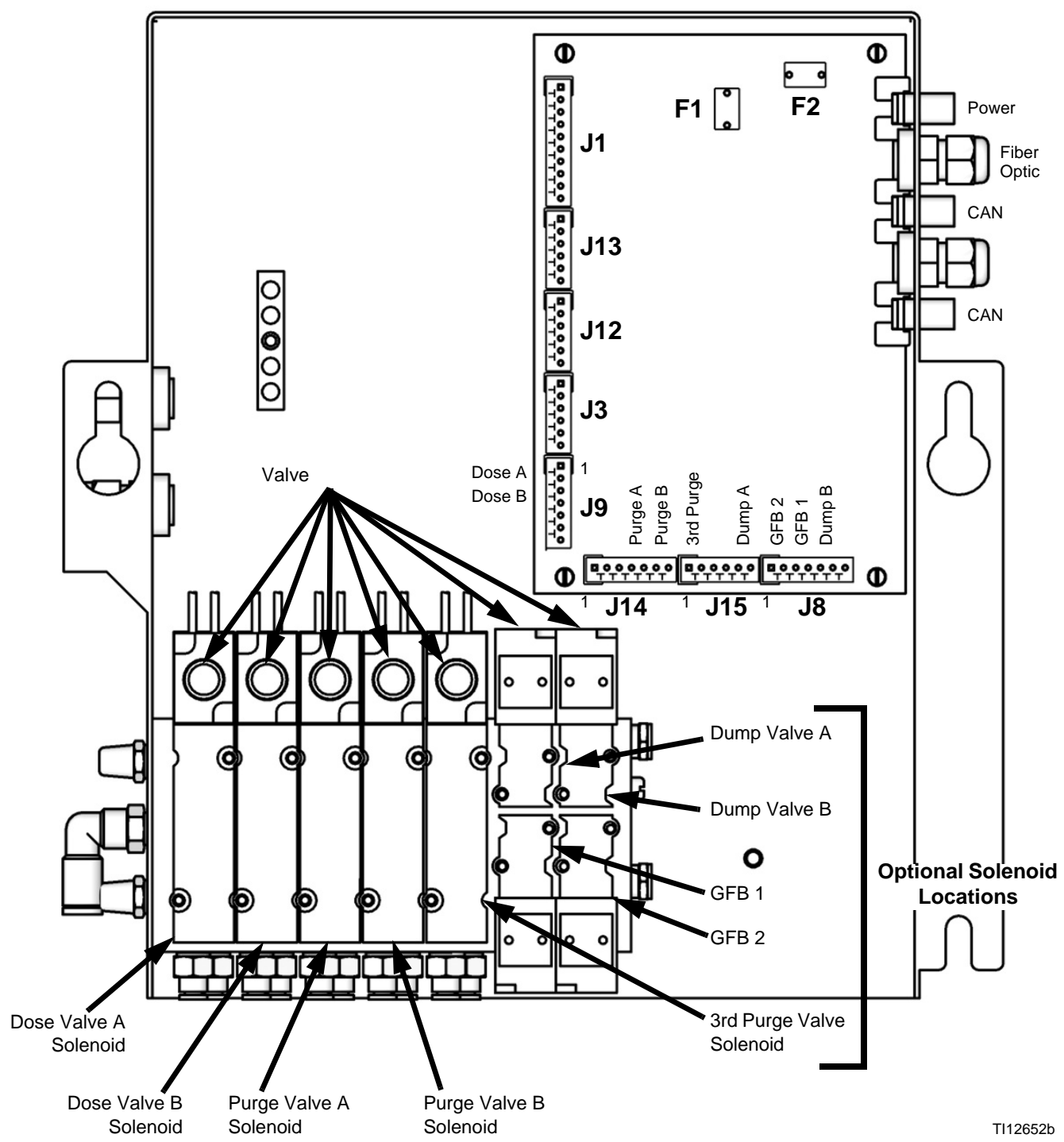

T112652b

FIG. 65. Fluid Solenoids

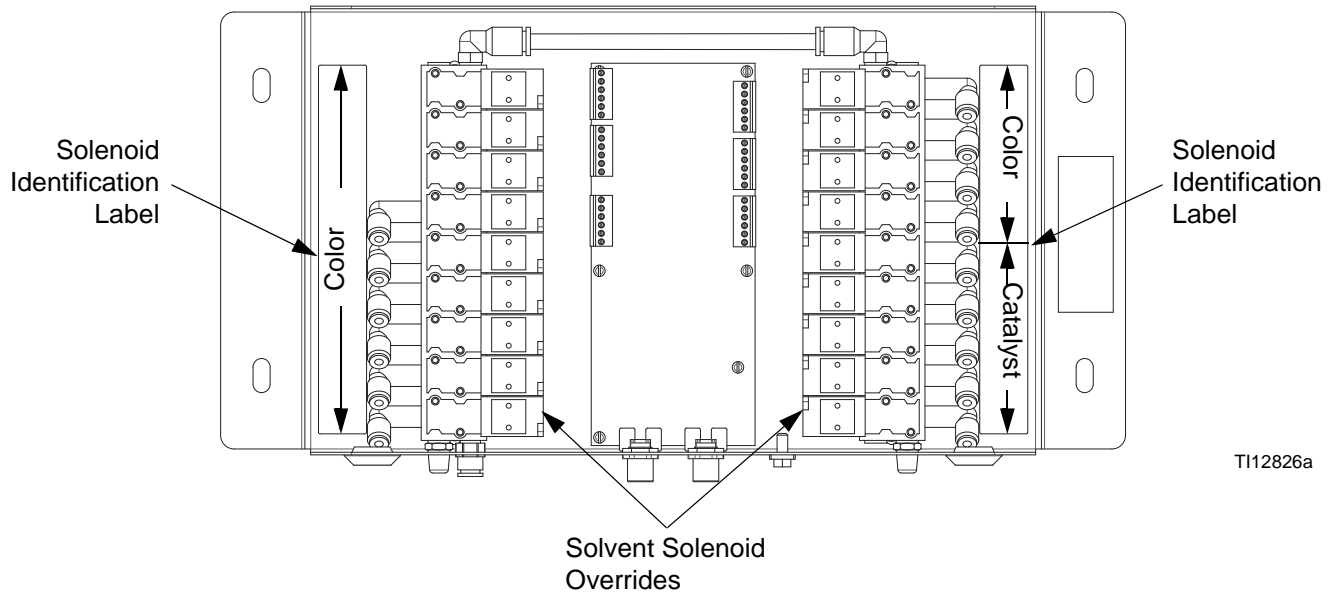

TI12826a



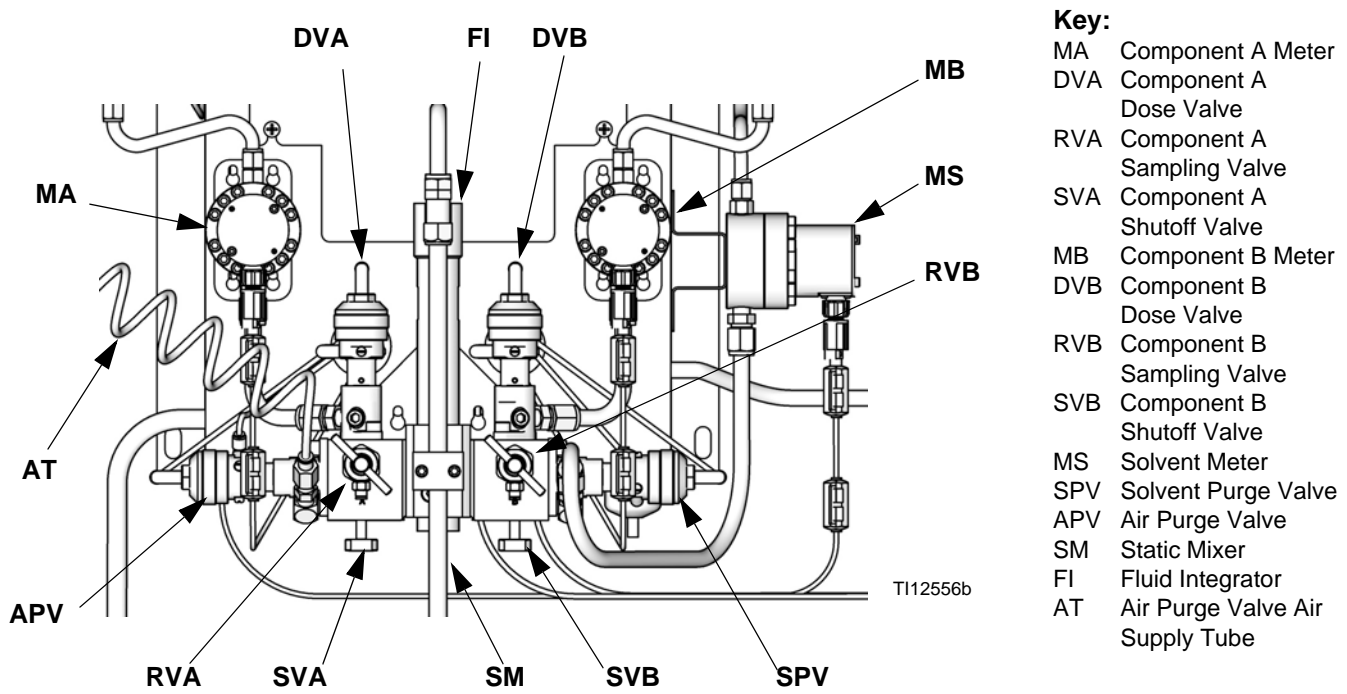



FIG. 66: Color Change Solenoids



TI12556b

FIG. 67. Wall Mount Fluid Station

Purging

						
<p>Read Warnings, page 7. Follow the Grounding instructions in your system Installation manual.</p> <p>To avoid splashing fluid in the eyes, wear eye protection.</p>						

There are 4 purging procedures in this manual:

- **Purging Mixed Material** (below)
- **Purging Using Recipe 0** (page 62)
- **Purging Fluid Supply System** (page 62)
- **Purging Sampling Valves and Tubes** (page 64)

Use the criteria listed in each procedure to determine which procedure to use.



Purging Mixed Material



There are times when you only want to purge the fluid manifold, such as:

- end of potlife
- breaks in spraying that exceed the potlife
- overnight shutdown
- before servicing the fluid manifold assembly, hose or gun.

Solvent purges the component B (catalyst, right) side of the mix manifold and the inner tube of the integrator. Air purges the component A (resin, left) side and the outer tube of the integrator.

1. Press the Standby  key on the Booth Control.

						
<p>Trigger the gun to relieve pressure.</p> <p>If you are using a high pressure gun, engage the trigger lock. Remove spray tip and clean tip separately.</p>						

						
<p>If using an electrostatic gun shut off the electrostatics before flushing the gun.</p>						

2. Set the solvent supply pressure regulator at a pressure high enough to completely purge the system in a reasonable amount of time but low enough to avoid splashing or an injection injury. Generally, a setting of 100 psi (0.7 MPa, 7 bar) is sufficient.

3. If using a gun flush box, place the gun into the box

and close the lid. Press the Purge  key on the Booth Control. The purge sequence automatically starts.

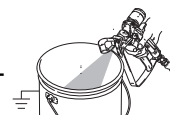

If the gun flush box is not used, trigger the gun into a grounded metal pail until the purge sequence is complete.



When done purging, the Booth Control automatically switches to Standby mode.

4. If the system is not completely clean, repeat step 3.

NOTE: If necessary, adjust purge sequence so only one cycle is required.

						
<p>Trigger the gun to relieve pressure. Engage trigger lock.</p>						

5. If spray tip was removed, reinstall it.
6. Adjust the solvent supply regulator back to its normal operating pressure.



Purging Using Recipe 0



Recipe 0 is typically used:



- in multiple color systems to purge out material lines without loading a new color
- at the end of a shift to prevent hardening of catalyzed material.

To setup Recipe 0, go to Advanced Setup. Select the Recipe tab and change the Recipe to 0. The Recipe 0 Setup Screen appears. Set the chop times from 0-999 seconds in increments of 1 second.

1. Press the Standby  key on the Booth Control.

						
Trigger the gun to relieve pressure.						
If you are using a high pressure gun, engage the trigger lock. Remove spray tip and clean tip separately.						

						
If using an electrostatic gun shut off the electrostatics before flushing the gun.						

2. If using a gun flush box, place the gun into the box and close the lid.
3. Select Recipe 0 and press Enter .
4. If a gun flush box is not used, trigger the gun into a grounded metal pail until the purge sequence is complete. 
5. The color change LED blinks while Recipe 0 runs and turns solid after purge sequence is complete.
6. If the system is not completely clean, you can repeat Recipe 0 by pressing Enter .



Purging Fluid Supply System



Follow this procedure before:

- the first time material is loaded into equipment*
- servicing
- shutting down equipment for an extended period of time
- putting equipment into storage

* Some steps are not necessary for initial flushing, as no material has been loaded into the system yet.

1. Press the Standby  key on the Booth Control.

						
Trigger the gun to relieve pressure.						
If you are using a high pressure gun, engage the trigger lock. Remove spray tip and clean tip separately.						

						
If using an electrostatic gun, shut off the electrostatics before flushing the gun.						

2. Attach solvent supply lines as follows:
 - **Single color/single catalyst systems:** disconnect the component A and B fluid supplies at the flow meter inlets, and connect regulated solvent supply lines.
 - **Multiple color/single catalyst systems:** disconnect only the component B fluid supply at the flow meter inlet and connect a regulated solvent supply line.
 - **Multiple color/multiple catalyst systems:** connect the solvent supply lines to the designated solvent valve on the color and catalyst valve stacks. Do not connect a solvent supply to either flow meter.

3. Adjust the solvent fluid supply pressure. Use the lowest possible pressure to avoid splashing.
4. Remove the Fluid Station cover to access the solenoid valves. See FIG. 65.
5. Purge as follows:

- **Single color/single catalyst systems:** Purge component A side. Press the manual override on the Dose Valve A solenoid valve and trigger the gun into a grounded metal pail.

Purge component B side. Press the manual override on the Dose Valve B solenoid valve and trigger the gun into a grounded metal pail until clean solvent flows from the gun.

Repeat to thoroughly clean the fluid integrator.

- **Multiple color/single catalyst systems:**
Select Recipe 0 and press Enter  to purge the component A side. The color change LED blinks while Recipe 0 runs and turns solid after purge sequence is complete.

Purge component B side. Press the manual override on the Dose Valve B solenoid valve and trigger the gun into a grounded metal pail until clean solvent flows from the gun.

Repeat to thoroughly clean the fluid integrator.





- **Multiple color/multiple catalyst systems:**
Select Recipe 0 and press Enter  to purge the component A side and the component B side. The color change LED blinks while Recipe 0 runs and turns solid after purge sequence is complete.

Repeat to thoroughly clean the fluid integrator.

6. Reinstall the Fluid Station cover.
7. Shut off the solvent fluid supply.
8. Disconnect the solvent supply lines and reconnect the component A and B fluid supplies.
9. See page 55 for **Start Up** procedure.

Purging Sampling Valves and Tubes

Follow this procedure after meter calibration.

1. Press the Standby  key on the Booth Control.
2. See FIG. 67. Close both fluid shutoff valves and sampling valves.
3. Route the sampling tubes into a grounded waste container.
4. **On a single color system**, attach a solvent supply line to Flow Meter A inlet.
5. On the EasyKey, press the Setup  key and access the Advanced Setup screens.
6. Press the Right Arrow  key to select the Calibration screen. Press the Down Arrow  key and select Purge from the menu. Press the Enter  key.

Dose A, solvent purge valve (B side), and color change solvent valves (if used) will open.

8. Close sampling valves.
NOTE: Select Abort on Calibration screen to cancel current calibration and close dose or purge valves.
9. Fully open both fluid shutoff valves.
10. **On a single color system**, reconnect component A fluid supply line to flow meter A.

NOTE: After calibration it is necessary to clean out contaminated mix material. Do a manual purge and resume the recipe just tested, or do Recipe 0 then go on to the next recipe.



Meter	A Meter 
Calibration	Start 
Measured Volume	Actual Volume
0 cc	<input type="text" value="0"/> cc
K-Factor	0.119 cc/pulse
Advanced	Recipe
Calibration	Home

FIG. 68. Calibration Screen



7. To avoid splashing, slowly open the sampling valves and dispense solvent until the valves and tubes are clean.

NOTE: When performing a calibration purge, the solvent valve(s) close automatically after 2 minutes or when Abort is selected on the screen.

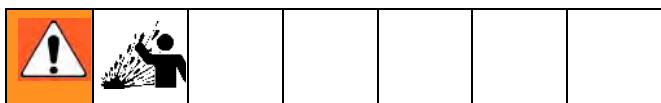
Solvent Push Feature

The Solvent Push feature enables the user to save some mixed material by pushing it out to the gun with solvent. The quantity saved is 50% of the potlife volume entered in **Advanced Setup Screen 1** on page 37. If there are 2 guns, the smaller potlife volume is used.

Solvent Push requires an accessory solvent meter (MS). Order Graco Part No. 16D329 S3000 Solvent Meter Kit. See manual 308778.

1. See FIG. 69. Install the solvent meter (MS) on the side of the fluid station, as explained in the ProMix 2KS Installation Manual.
2. To enable Solvent Push, select "Solvent" or "3rd Valve," as desired. See **Option Screen 2**, page 35.

NOTE: If you are using a 3rd purge valve instead of the solvent purge valve to run the Solvent Push feature, connect the solvent supply line from the solvent meter to the inlet of the 3rd purge valve.



NOTE: The system must be in Mix to initiate Solvent Push.

3. Press and hold the Mix  key for 5 seconds to turn on Solvent Push. The green Mix LED will light and the Recipe LED will blink. The system will

close the Dose Valves (DVA, DVB) and open the Solvent Purge Valve (SPV).

4. The system will dispense solvent to push the mixed material out to the gun. The Booth Control display alternately shows dashes and the percent remaining (0-99%) of the 50% of the potlife volume.

NOTE: To manually interrupt Solvent Push, press the

Standby  key. The Solvent Purge Valve (SPV) or 3rd purge valve will close. To re-enter Solvent Push, press the Mix  key.

5. When the total solvent dispensed exceeds 50% of the potlife volume, the system will go into Standby

 mode.

6. Perform a manual purge or recipe change to purge the remaining mixed material. This will clear the system out of Solvent Push, allowing you to resume Mix mode.

NOTE: Once the system senses that solvent exceeds 50% of potlife volume, attempts to re-enter Solvent Push will cause an Overdose A/B Alarm (E-5, E-6).

Key:

DVA	Component A Dose Valve
DVB	Component B Dose Valve
MS	Solvent Meter (required)
SPV	Solvent Purge Valve
APV	Air Purge Valve
SMC	Solvent Meter Cable
SS	Solvent Supply Line

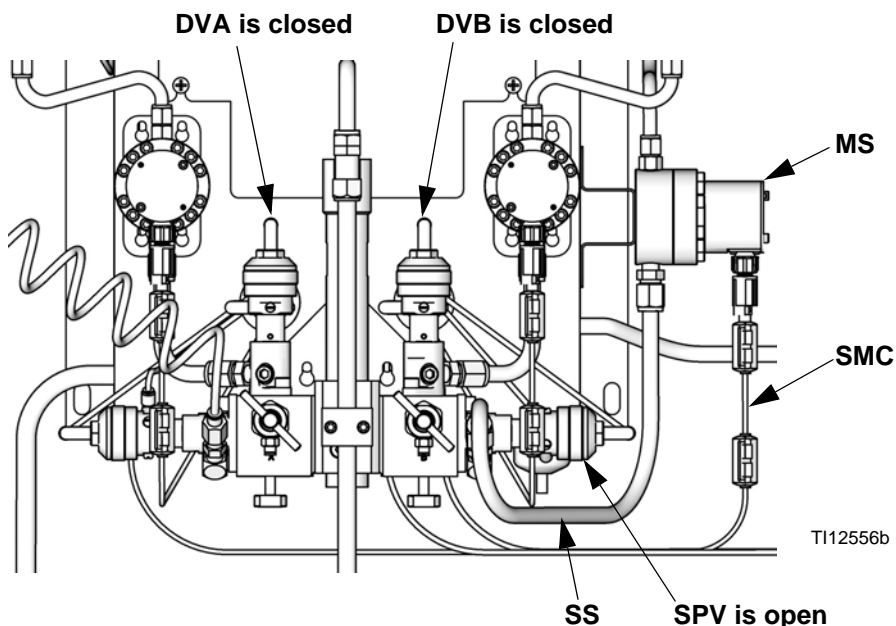

FIG. 69. Solvent Push Setup

Mix Fill Push Feature

The Mix Fill Push feature enables the user to prevent potlife expiration of material by mixing and flowing new material through the Gun Flush Box.

Mix Fill Push requires an accessory Gun Flush Box for each gun that will use this feature. Order Graco Part No. 15V826 Fun Flush Box Kit. See manual 312784.

NOTE: If the gun is not in the box the Mix Fill Push feature will not operate.

NOTE: The Mix Fill Push operation will run every time the Potlife alarm occurs with the gun in the box. Unattended systems can therefore repeatedly perform this operation as the potlife keeps happening.

Mix Fill Push requires a Gun Flush Box for the gun. If two guns are used, each requires a Fun Flush Box for this feature to operate. The second Gun Flush Box must be configured as a Special Output. See **Configure Screen 5** on page 33.

To enable Mix Fill Push, select "Mix Fill Push" in the Auto Dump field. See **Option Screen 2**, page 35.

1. The system gets a Potlife alarm.
2. The buzzer will do a double "chirp" every 4 seconds to indicate an impending Mix Fill Push.
3. After waiting for the 2-minute Auto Dump time the system will run the Mix Fill Push.

NOTE: On a one-gun system the gun must be in the GFB. On a 2-gun system both guns must be in the GFBs.

4. If one of the guns in not in the GFB, the system will not perform any of the Mix Fill Push or Auto Dump operations. The system will retry every 30 seconds in case the gun is then installed in the GFB.
5. With the guns in the GFBs, the system will proportion mixed material through the guns in order to reset the potlife volume.
6. The alarm is cleared.
7. The event is logged in the Alarm Log as two alarms: E-5 Overdose A and E-6 Overdose B.

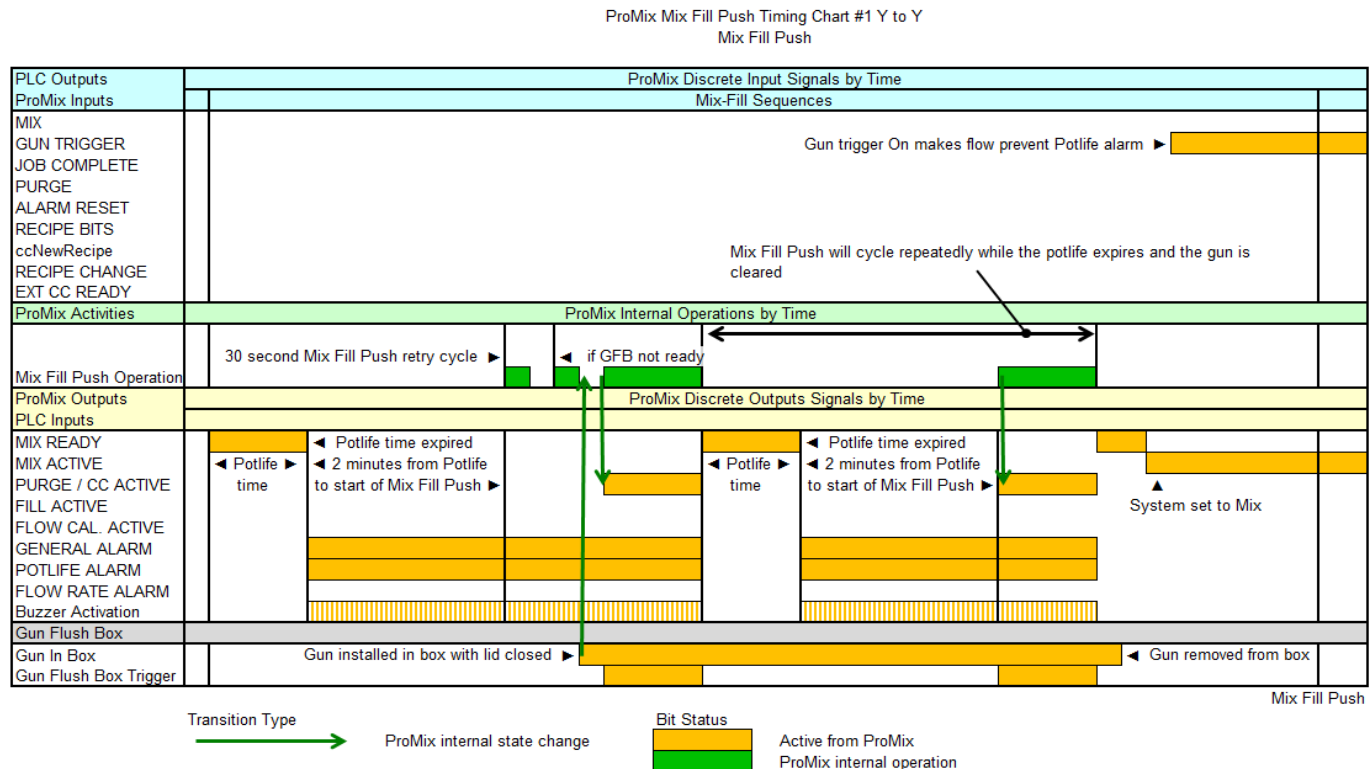

FIG. 70. Mix Fill Push Timing Chart

Meter Calibration



To avoid splashing fluid in the eyes, wear eye protection. The fluid shutoff valves and ratio check valves are retained by mechanical stops that prevent accidental removal of the valve stem while the manifold is pressurized. If you cannot turn the valve stems manually, relieve the system pressure, then disassemble and clean the valve to remove the resistance.

Calibrate the meter:

- The first time the system is operated.
- Whenever new materials are used in the system, especially if the materials have viscosities that differ significantly.
- At least once per month as part of regular maintenance.
- Whenever a flow meter is serviced or replaced.

NOTE:

- K-factors on the **Calibration Screen** are updated automatically after the calibration procedure is completed.
 - K-factor values on the screen are viewable only. If needed, you can manually edit the K-factors in **Advanced Setup Screen 4** (page 38) or **Recipe Setup Screen 5** (page 43).
 - All values on this screen are in cc, independent of the units set in **Configure Screen 1**.
 - The controller will use the active recipe K-factors for meter calibration. **The active recipe must be recipe 1 to recipe 60. Recipes 0 and 61 do not have K-factor values.**
1. Before calibrating meter A or B, prime the system with material. For a color/catalyst change system, make sure the color/catalyst valve is open.
 2. Shut off all spray or dispense devices connected to the ProMix.
 3. Close both fluid shutoff valves and sampling valves.

4. Place the beakers (minimum size - 250 cc) in holders. Put the sampling tubes into the beakers.

NOTE: If tubes need replacing, use 5/32 in. or 4 mm OD tubing.

5. On the EasyKey, press the Setup key to access setup screens.
6. Select **Recipe & Advanced Setup** and press the Enter key to select.

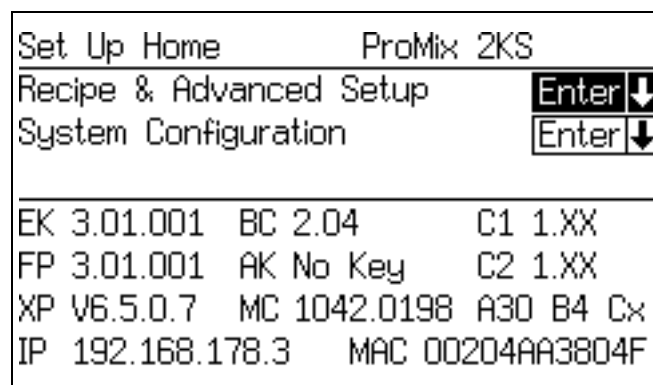

7. Press the Right Arrow key to select the **Calibration Screen**. Press the Enter key to select either A Meter, B Meter, or Solvent. Press the Down Arrow key and select Start from the menu. Start only one at a time.

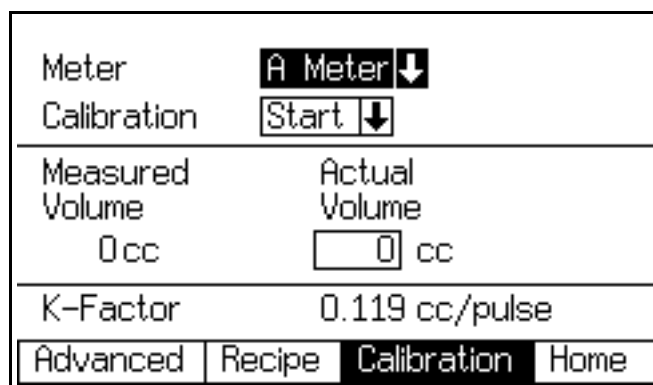

8. Dispense component A, B, or Solvent into beaker.

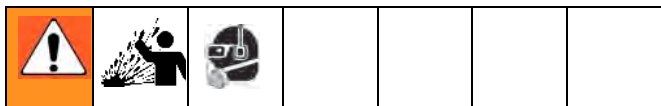

- a. To avoid splashing, slowly open sampling valves.
 - b. For more accurate calibration, adjust the valve to dispense at a flow rate similar to your production spray flow rate.
 - c. Dispense a minimum of 250 cc; make sure enough material is dispensed to accurately read the volume with your beaker. The A and B volumes do not have to be equal or at any particular ratio.
 - d. Close sampling valve tightly.
9. The volume that the ProMix measured displays on the EasyKey.
10. Compare the amounts on the EasyKey to the amount in the beakers.

NOTE: For maximum accuracy, use a gravimetric (mass) method to determine the actual volumes dispensed.

11. If the screen and actual volumes are different, enter the actual dispensed volume in cc for A, B, or Solvent Volume field, and press the Enter  key.

If the value was substantially different, repeat the calibration process.

NOTE: If the screen and actual volume is the same or if for any reason you want to cancel the calibration procedure, scroll to Abort on the **Calibration**

Screen menu and press the Enter  key.

12. After the volume for A, B, or Solvent is entered, the ProMix 2KS controller calculates the new flow meter K-factor and shows it on the **Calibration Screen**.

NOTE: K-factor values on the screen are viewable only. If needed, you can manually edit the K-factors in **Advanced Setup Screen 4** (page 38) or **Recipe Setup Screen 5** (page 43).

13. Always purge sampling valves after calibrating meters. Use one of the following methods.

- Follow the **Purging Sampling Valves and Tubes** procedure, page 64.
- Place the sampling valve fluid tubes into a compatible cleaning fluid (TSL or solvent) or cap them.

NOTE: If fluid hardens in sampling tubes, replace them with 5/32 in. or 4 mm OD tubing.

14. Make sure both sampling valves are closed and both fluid shutoff valves are fully open.

15. Before you begin production, clear the system of solvent and prime it with material.

- a. Go to Mix mode.
- b. Trigger the gun into a grounded metal pail until mixed material flows from the gun nozzle.
- c. To begin operation, see **Start Up**, page 55.



Color Change

Color Change Procedures

Multiple Color Systems

1. Shut off air to the gun.
2. Place the gun in the gun flush box if used, and close the lid.

3. Switch to Standby  mode at the Booth Control.

4. Use the scroll keys,  or , to select the new color. Press Enter  to begin the color change sequence.

5. If a gun flush box is not used, trigger the gun into a grounded metal pail until the color change sequence is complete.



6. When the color change indicator light stops flashing on the Booth Control, the color change sequence is complete.

NOTE: The color change timer does not start until the gun is triggered and fluid flow is detected. If no flow is detected within 2 minutes, the color change operation aborts. The Booth Control enters Standby

 mode at the previous color.

7. When you are ready to spray, remove the gun from the gun flush box if used, and close its door.

NOTE: The gun flush box door must be closed for the atomizing air valve to open.

8. Press the Mix  key to start spraying.

Single Color Systems

1. Follow procedure for **Purging Fluid Supply System**, page 62.
2. Load the new color. See **Start Up**, page 55.
3. Press the Mix  key to start spraying.

Color Change Sequences

FIG. 71 through FIG. 80 illustrate various color change sequences. See Table 9 to determine which figure to reference, based on the recipe change and system configuration. The time sequences are detailed in the following paragraphs.

NOTE: For software version 2.04.xxx and older, the system uses the color/catalyst purge and fill times from the new recipe.

NOTE: See **Setup Mode** on page 27 to select purge sources and set desired purge, chop, and fill times.

NOTES:

- The system uses old recipe data for the purge cycle. However, it opens the new color/catalyst valve based on the new recipe data.
- The system uses the new recipe data for the fill cycle.
- For the one gun flush box (GFB) option, the spray gun must be inserted in the GFB during the entire color change cycle (purge and fill). The GFB trigger output will be on during the recipe change cycle.
- For the two gun flush box (GFB) option, both spray guns must be inserted in the GFBs during the entire color change cycle (purge and fill). The system will turn each GFB trigger output on and off based on the preset time for each gun.
- For Special Outputs options, the system will turn each output on and off based on the preset times. Each Special Output has two different start times and durations.
- For systems without dump valves, the First Purge begins after the Color/Catalyst Change steps are completed.
- Dump Valve B is required for a Catalyst Change system.
- When going from Recipe X to Recipe 0, only the purge cycle data from Recipe 0 is used.
- When going from Recipe 0 to Recipe Y, only the fill cycle data from Recipe Y is used.

Color Purge/Dump

- This sequence flushes out the color with solvent, from the color valve to the Dump A valve.
- The color change solvent valve and the Dump A valve open during the Purge Time.
- The color change solvent valve closes when the Purge Time expires.

Color Fill

- This sequence fills the line with the new color all the way to the Dump A valve.
- The new color valve and the Dump A valve open during the Fill Time.
- The new color valve and the Dump A valve close when the Fill Time expires.

Catalyst Purge/Dump

- This sequence flushes out the catalyst with solvent, from the catalyst valve to the Dump B valve.
- The catalyst change solvent valve and the Dump B valve open during the Purge Time.
- The catalyst change solvent valve closes when the Purge Time expires.

Catalyst Fill

- This sequence fills the line with the new catalyst all the way to the Dump B valve.
- The new catalyst valve and the Dump B valve open during the Fill Time.
- The new catalyst valve and the Dump B valve close when the Fill Time expires.

First Purge

Select the First Purge Source (air, solvent, or 3rd valve) and First Purge Time. For most applications, air is selected.

The system purges the old material from the dose valves to the gun, using only the selected purge media (usually air). The selected purge valve opens during the First Purge Time and closes when the time expires.

Chop Cycle

Select the Chop Type (air/solvent or air/3rd valve) and Chop Times.

The air purge valve opens only during the air chop cycle, and the solvent (or 3rd valve) opens only during the solvent chop cycle. The number of chop cycles is determined by dividing the Total Chop Time by the sum of the Air and Solvent Chop Times.

Final Purge

Select the Final Purge Source (air, solvent, or 3rd valve) and Final Purge Time. For most applications, solvent is selected.

The system fills the line with solvent from the dose valves to the gun, using only the selected purge media (usually solvent). The selected purge valve opens during the Final Purge Time and closes when the time expires.

Fill

This sequence fills the line from the dose valves to the gun, and is also referred to as the mixed material fill. The system begins mixing components A and B until the Fill Time expires.

Table 9: Color Change Chart Reference

Starting Recipe	Ending Recipe	Change Type	Dump A	Exiting Fill	Refer to Fig.
X	Y	Change	Yes	NA	FIG. 71
X	Y	Change	No	NA	FIG. 72
0	Y	Fill	Yes	Yes	FIG. 73
0	Y	Fill	Yes	No	FIG. 74
0	Y	Fill	No	Yes	FIG. 75
0	Y	Fill	No	No	FIG. 76
X	0	Purge	Yes	NA	FIG. 77
X	0	Purge	No	NA	FIG. 78
0	0	Purge	Yes	NA	FIG. 79
0	0	Purge	No	NA	FIG. 80

NOTE: For manual systems, the Digital I/O signals identified in the color charts on the following pages represent internal states.

ProMix 2KS Recipe Change Chart #1 X to Y
 Stack Valves A1 to A2, B1 to B2
 Dump A Enabled, 3rd Flush Valve Enabled

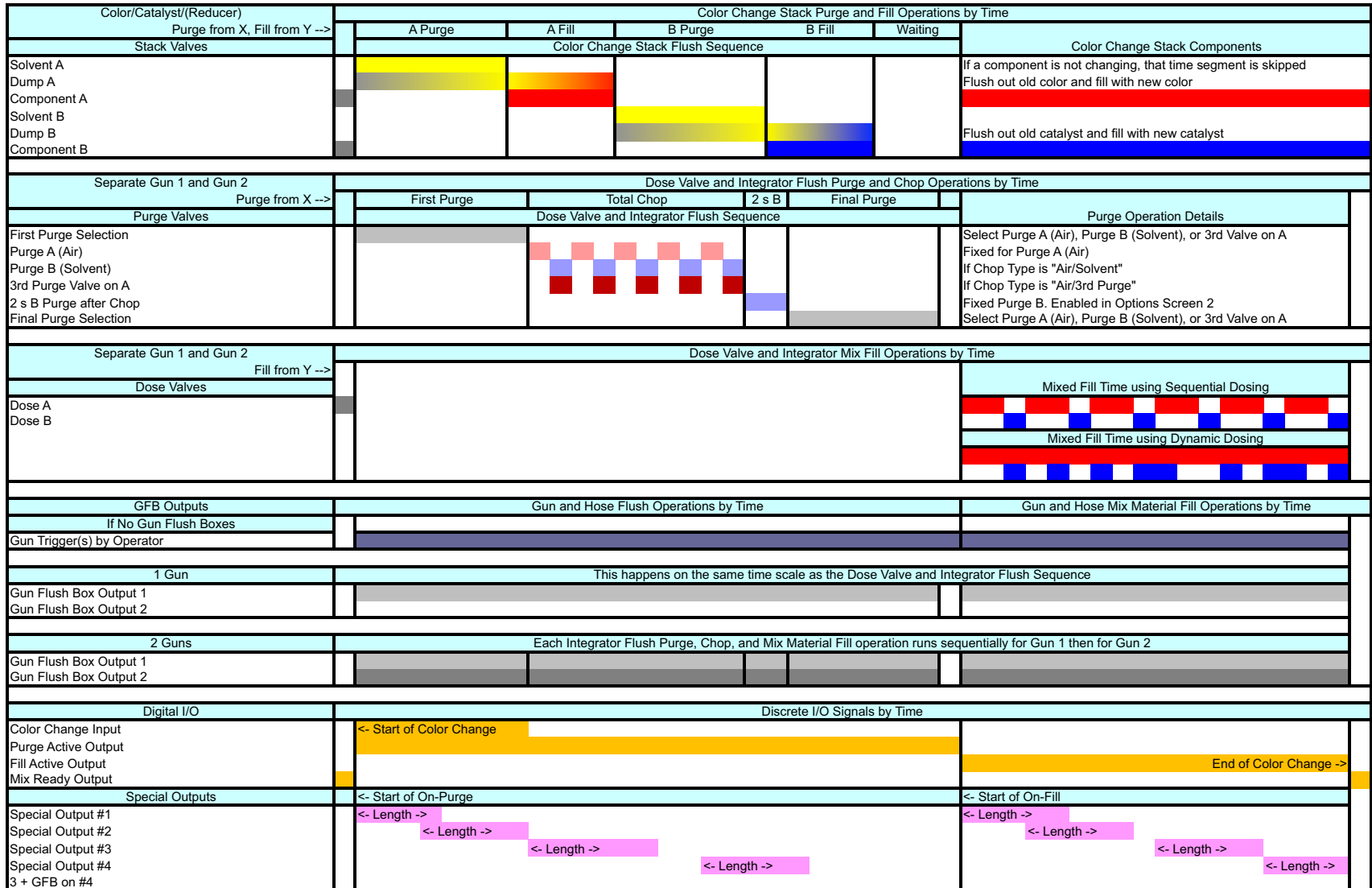

2KS X to Y K15

Fig. 71: ProMix 2KS Recipe Change Chart #1 X to Y

ProMix 2KS Recipe Change Chart #2 X to Y
 Stack Valves A1 to A2, B1 to B2
 No Dump A, 3rd Flush Valve Enabled

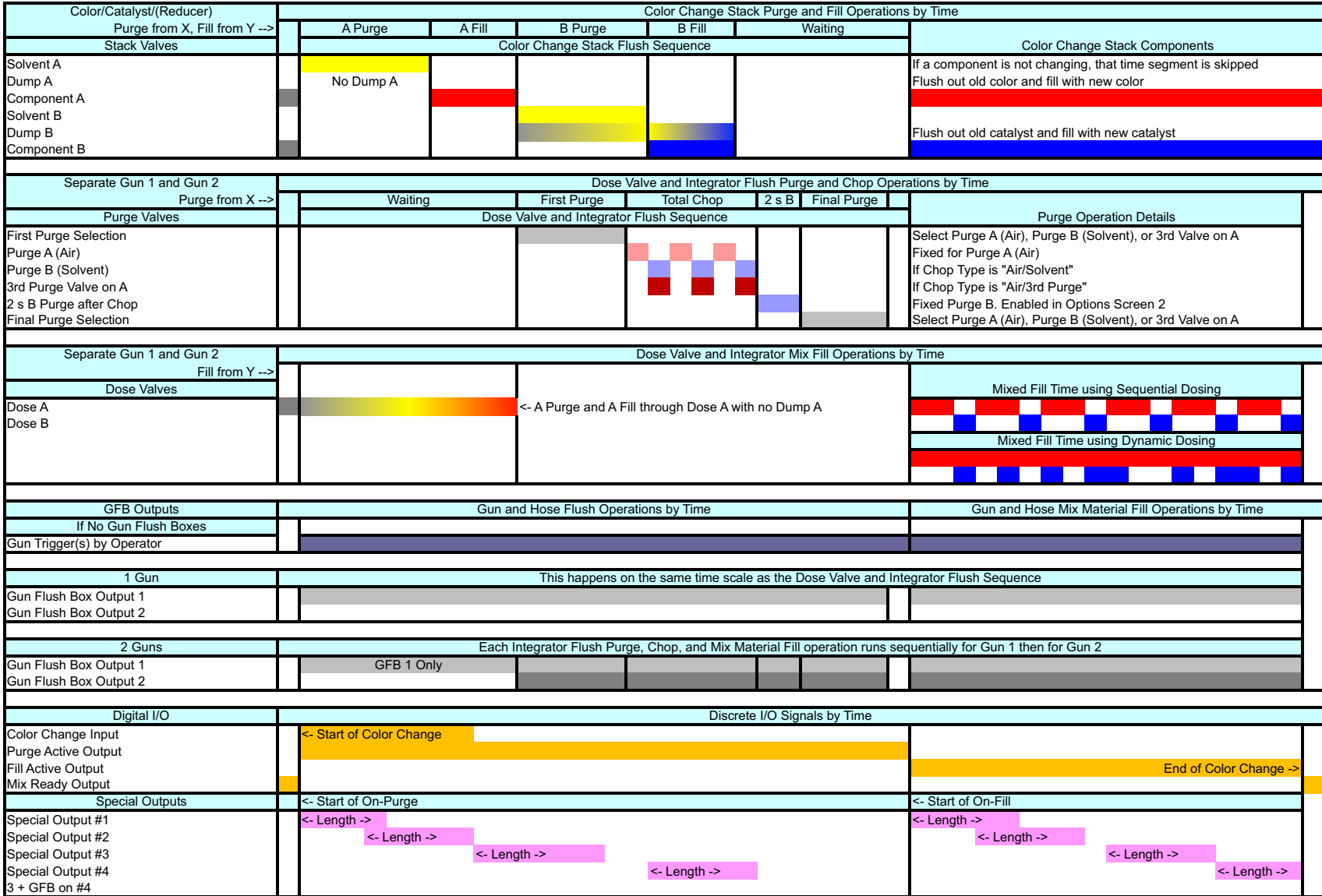

2KS X to Y K13

FIG. 72: ProMix 2KS Recipe Change Chart #2 X to Y

ProMix 2KS Recipe Fill Chart #3 0 to Y
 Stack Valves A1, B1
 Dump A Enabled, 3rd Flush Valve Enabled
 Exiting Fill Enabled

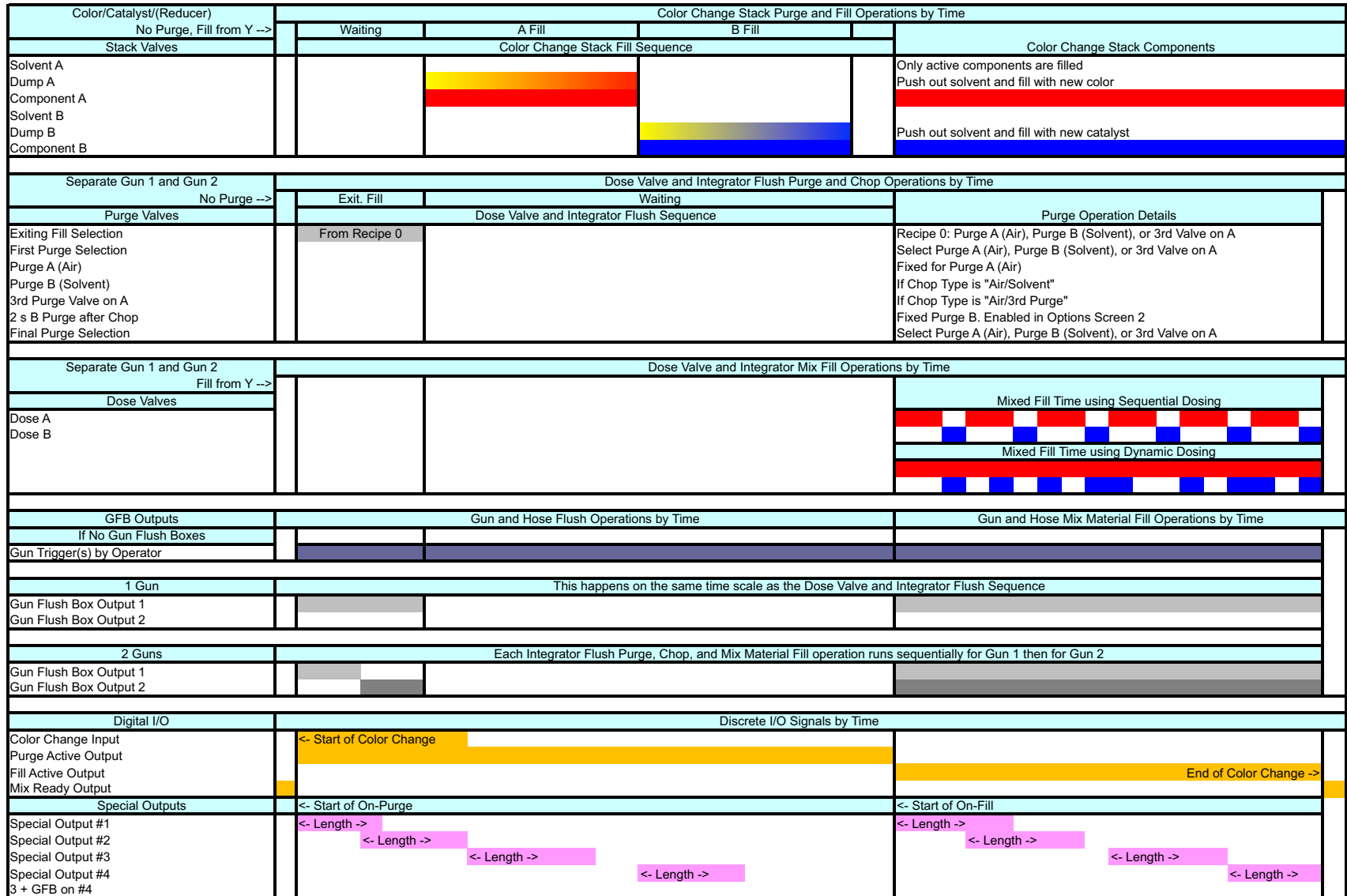

2KS 0 to Y K15

Fig. 73: ProMix 2KS Recipe Fill Chart #3 0 to Y

ProMix 2KS Recipe Fill Chart #4 0 to Y
 Stack Valves A1, B1
 Dump A Enabled, 3rd Flush Valve Enabled
 No Exiting Fill

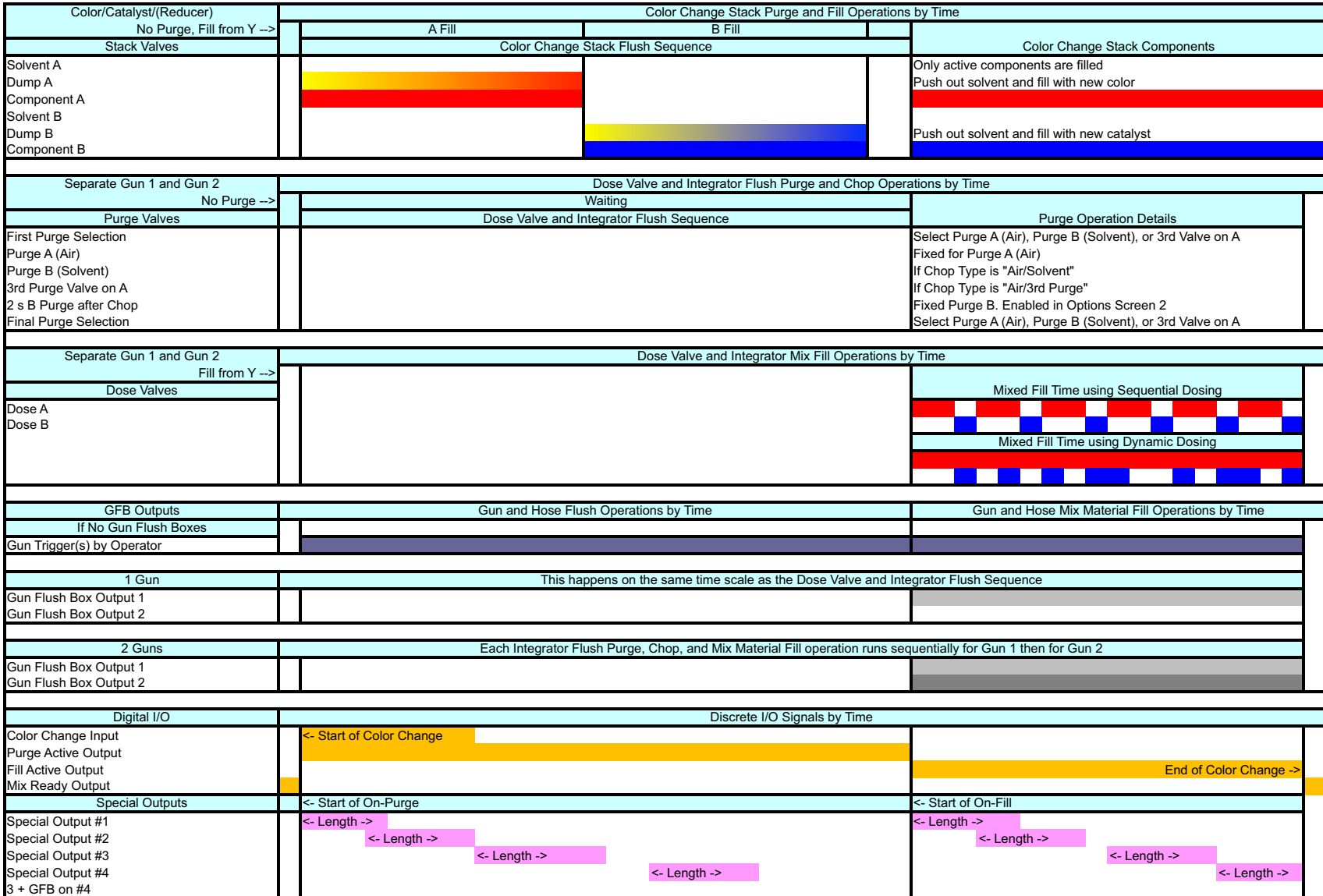

2KS 0 to Y K14

FIG. 74: ProMix 2KS Recipe Fill Chart #4 0 to Y

ProMix 2KS Recipe Fill Chart #5 0 to Y
 Stack Valves A1, B1
 No Dump A, 3rd Flush Valve Enabled
 Exiting Fill Enabled

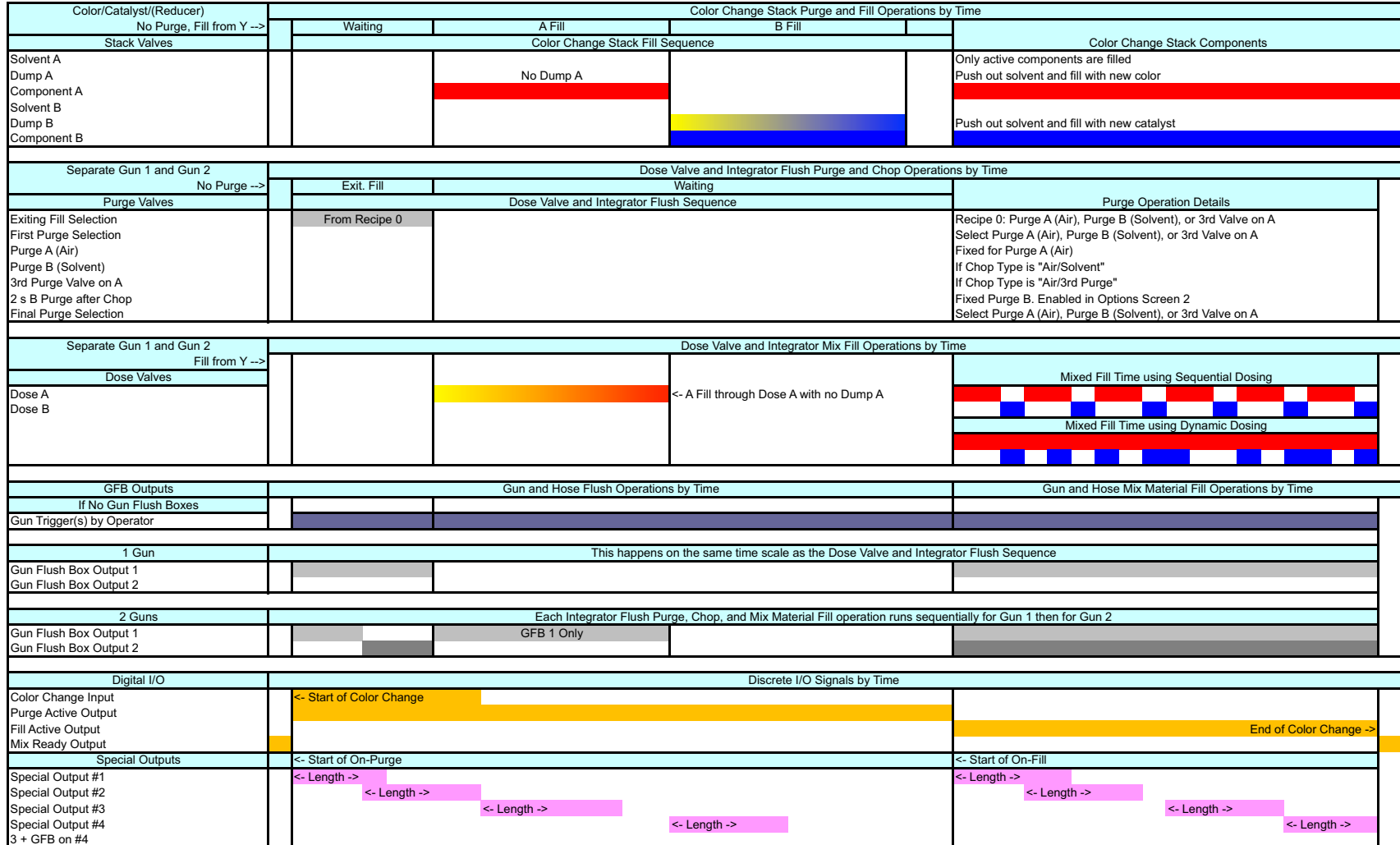

2KS 0 to Y K13

Fig. 75: ProMix 2KS Recipe Fill Chart #5 0 to Y

ProMix 2KS Recipe Fill Chart #6 0 to Y
 Stack Valves A1, B1
 No Dump A, 3rd Flush Valve Enabled
 No Exiting Fill

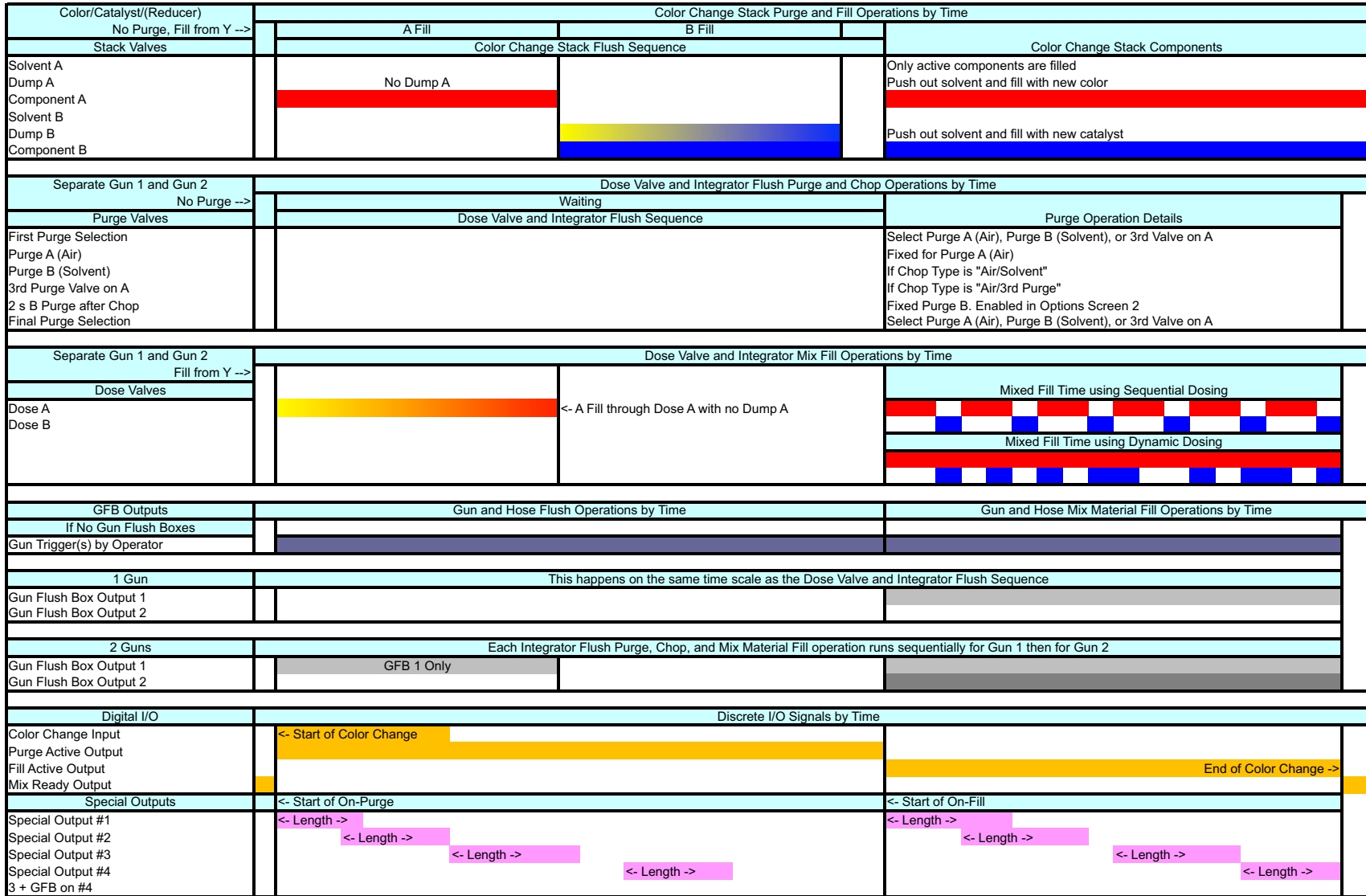

2KS 0 to X K12

Fig. 76: ProMix 2KS Recipe Fill Chart #6 0 to Y

ProMix 2KS Recipe Purge Chart #7 X to 0
 Stack Valves Off
 Dump A Enabled, 3rd Flush Valve Enabled

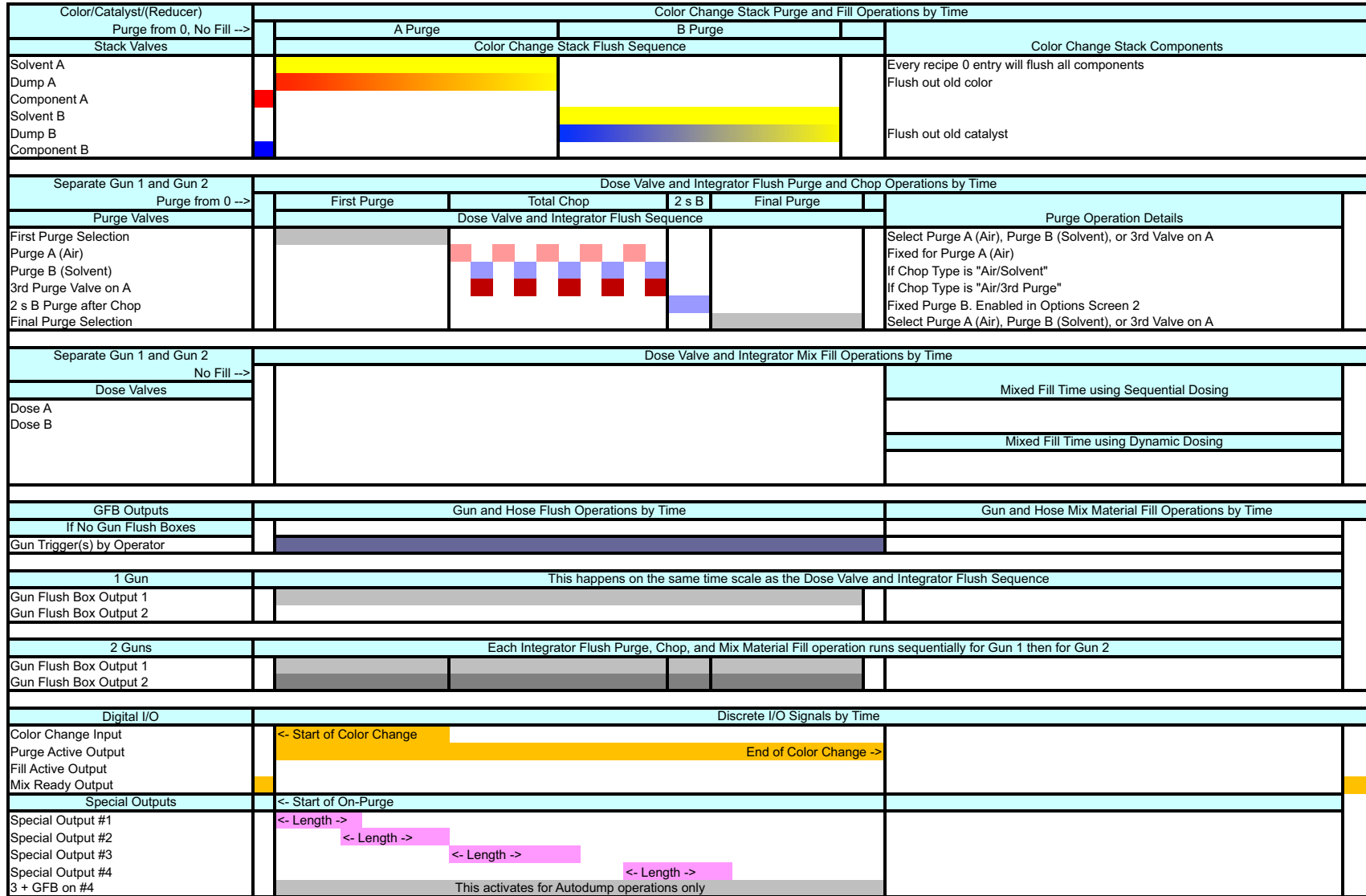

2KS X to 0 K15

Fig. 77: ProMix 2KS Recipe Purge Chart #7 X to 0

ProMix 2KS Recipe Purge Chart #8 X to 0
 Stack Valves Off
 No Dump A, 3rd Flush Valve Enabled

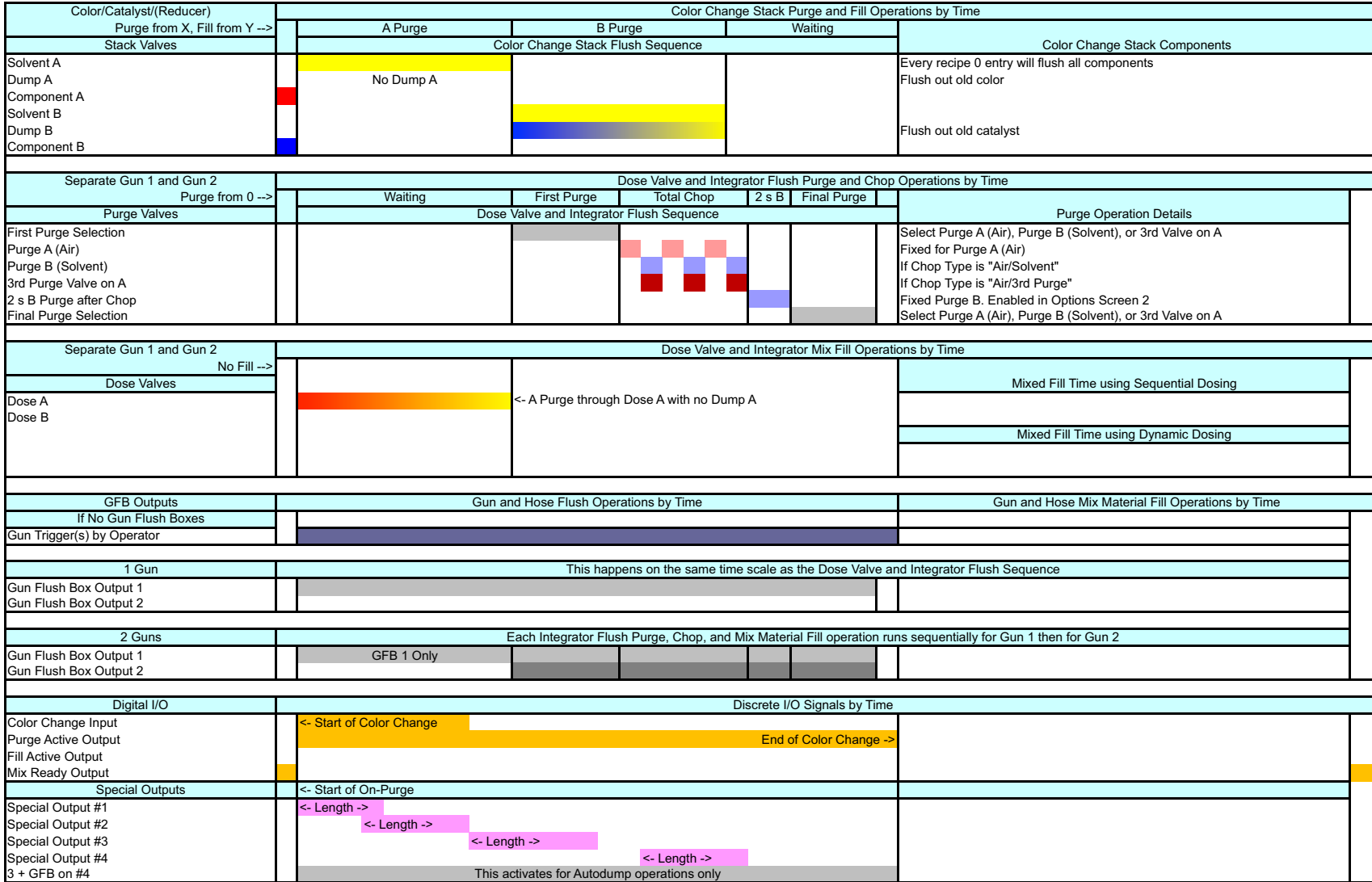

2KS X to 0 K13

FIG. 78: ProMix 2KS Recipe Purge Chart #8 X to 0

ProMix 2KS Recipe Purge Chart #9 0 to 0
 Stack Valves Off
 Dump A Enabled, 3rd Flush Valve Enabled
 Exiting Fill Enabled

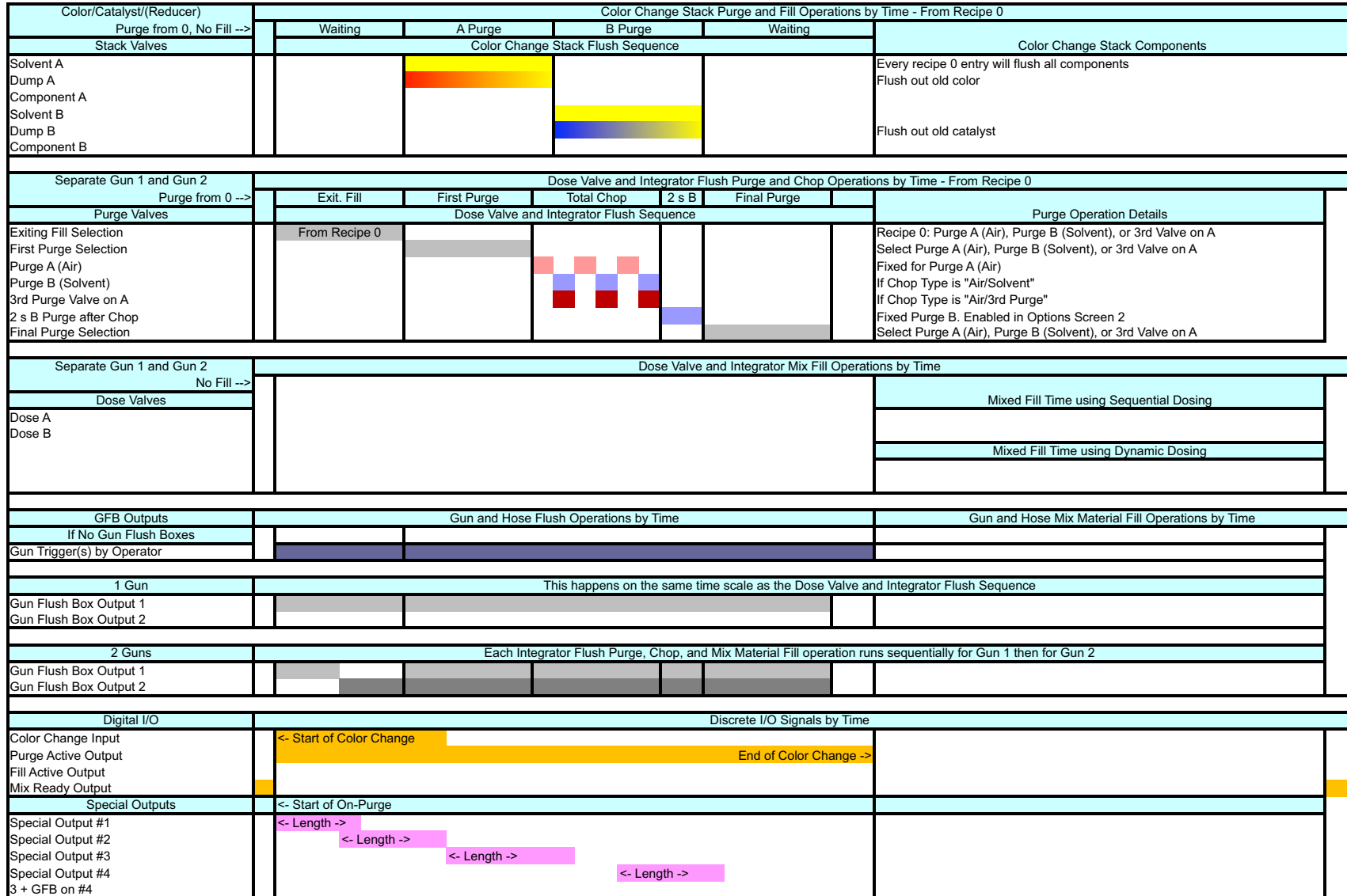

2KS 0 to 0 K3

Fig. 79: ProMix 2KS Recipe Purge Chart #9 0 to 0

ProMix 2KS Recipe Purge Chart #10 0 to 0
 Stack Valves Off
 No Dump A, 3rd Flush Valve Enabled
 Exiting Fill Enabled



2KS 0 to 0 K1

FIG. 80: ProMix 2KS Recipe Purge Chart #10 0 to 0

Alarms and Warnings

NOTE: Do not use the fluid in the line that was dispensed off ratio as it may not cure properly.

System Alarms

System alarms alert you of a problem and help prevent off-ratio spraying. If an alarm occurs, operation stops and the following occurs:

- A red LED illuminates steadily or blinks on the Booth Control.
- Booth Control displays an alarm E-Code, E-1 to E-28. See FIG. 81.
- Buzzer sounds (for E-2 only; see page 31 to set for all alarms).
- Status bar on the EasyKey Display shows the alarm E-Code with a description (see Table 10).

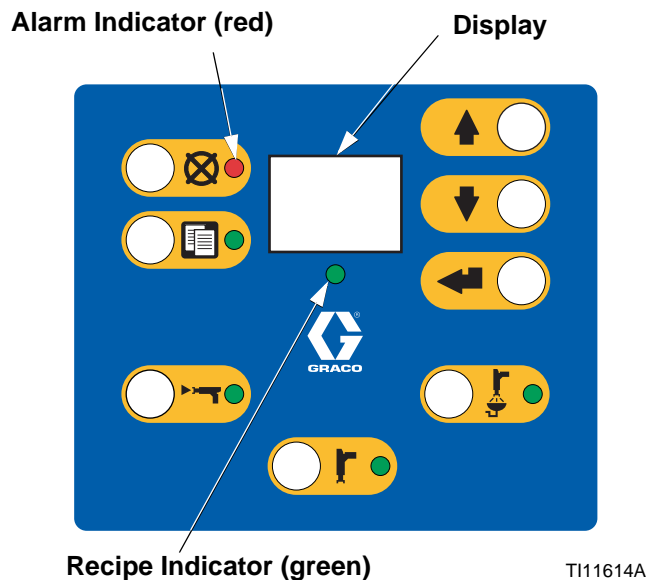

FIG. 81. Booth Control

System Warnings

Table 10 lists the System Warning Codes. Warnings do not stop operation or sound an alarm. They are saved in the date/time stamped log, which can be viewed on a PC, using the ProMix 2KS Web Interface (see manual 313386).

To Reset Alarm and Restart

NOTE: When an alarm occurs be sure to determine the E-Code before resetting it. See Table 10. If you forget which E-Code occurred, use the **Alarms Screens** (page 26) to view the last 10 alarms, with date and time stamps.

To reset alarms, see Table 11. Many alarms can be

cleared by simply pressing the Alarm Reset  key.

Table 10: System Alarm/Warning Codes

Code	Description	Details
E-1	Communication Error Alarm	Page 83
E-2	Potlife Alarm	Page 83
E-3	Ratio High Alarm	Page 84
E-4	Ratio Low Alarm	Page 85
E-5	Overdose A/B Dose Too Short Alarm	Page 86
E-6	Overdose B/A Dose Too Short Alarm	Page 86
E-7	Dose Time A Alarm	Page 87
E-8	Dose Time B Alarm	Page 87
E-9	Not used	NA
E-10	Remote Stop Alarm	Page 88
E-11	Purge Volume Alarm	Page 88
E-12	CAN Network Communication Error Alarm	Page 89
E-13	High Flow Alarm	Page 90
E-14	Low Flow Alarm	Page 90
E-15	System Idle Warning	Page 90
E-16	Setup Change Warning	Page 90
E-17	Power On Warning	Page 90
E-18	Defaults Loaded Warning	Page 90
E-19	I/O Alarm	Page 91
E-20	Purge Initiate Alarm	Page 92
E-21	Material Fill Alarm	Page 92
E-22	Tank A Low Alarm	Page 92
E-23	Tank B Low Alarm	Page 92
E-24	Tank S Low Alarm	Page 92
E-25	Auto Dump Complete Alarm	Page 93
E-26	Color/Catalyst Purge Alarm	Page 93
E-27	Color/Catalyst Fill Alarm	Page 93
E-28	Mix Fill Push Complete	Page 93

Alarm Troubleshooting

Table 11. Alarm Troubleshooting

E-1: COMM ERROR	
Cause	Solution
No power to the EasyKey.	Connect power to EasyKey.
No power to Fluid Station. The intrinsically safe power cable between the EasyKey and Fluid Station is not connected.	Verify that the cable is correctly connected. See Installation manual.
No power to Fluid Station. The fluid control board fuse is blown.	Verify condition of fuse and replace if necessary. See Repair-Parts manual.
The fiber optic cable between the EasyKey and Fluid Station is not connected.	Verify that the cable is correctly connected. See Installation manual.
The fiber optic cable is cut or bent.	Verify that the cable has not been cut or bent at a radius smaller than 1.6 in. (40 mm).
Dirty fiber optic cable ends.	Disconnect fiber optic cable ends and clean with a lint-free cloth.
A communication cable or connector failed.	Replace cable.
E-2: POTLIFE ALARM	
Cause	Solution
The potlife time has been exceeded for the mixed material.	Press the Alarm Reset  key to stop the audible alarm. Purge the system with solvent, fresh mixed material, or a new color:
NOTICE	
To prevent mixed material from curing in the equipment, do not shut off power. Follow one of the solutions at right.	<ul style="list-style-type: none"> • Solvent Purge - See Purging Mixed Material on page 61. The system purges until the preset purge time is complete. • New Mixed Material Purge - Go to Mix mode and spray the required volume to restart the timer. • Color Change - Perform a color change, page 69.

Table 11. Alarm Troubleshooting

E-3: RATIO HIGH ALARM	
Sequential Dosing System	
The mix ratio is higher than the set tolerance on the previous dose cycle.	
Dynamic Dosing System	
The mix ratio is higher than the set tolerance for an A to B component volume comparison.	
Cause	Solution
There is too little restriction in the system.	<ul style="list-style-type: none"> • Check that the system is fully loaded with material. • Check that the supply pump's cycle rate is set properly. • Check that the spray tip/nozzle is properly sized for the flow and application, and that it is not worn. • Check that the fluid regulator is set properly.
If the alarm occurs during start up, after purging, the flow rate was probably too high.	Restrict gun needle travel to slow down the initial fluid delivery rate until fluid hoses are loaded with material.
If the alarm occurred after you were spraying for some time, the pressures from the fluid supplies could be unbalanced.	Adjust component A and B fluid supply regulator pressures until they are about equal. <i>If the pressures are already about equal</i> , verify that component A and B dose valves are operating properly.
Slow actuation of the component A or B valves. This can be caused by:	Manually operate the Dispense A and B solenoid valves as instructed in the ProMix 2KS Repair-Parts manual to check operation.
<ul style="list-style-type: none"> • Air pressure to the valve actuators is too low. 	<ul style="list-style-type: none"> • Increase air pressure. Air pressure must be 75-120 psi (0.52-0.84 MPa, 5.2-8.4 bar); 120 psi is recommended.
<ul style="list-style-type: none"> • Something is restricting the solenoid or tubing and interrupting valve actuation air. 	<ul style="list-style-type: none"> • There may be dirt or moisture in the air supply. Filter appropriately.
<ul style="list-style-type: none"> • A dose valve is turned in too far. 	<ul style="list-style-type: none"> • Refer to Table 7: Mix Manifold Valve Settings, page 55, for adjustment guidelines.
<ul style="list-style-type: none"> • Fluid pressure is high and air pressure is low. 	<ul style="list-style-type: none"> • Adjust air and fluid pressure. See recommended air pressure above.

Table 11. Alarm Troubleshooting

E-4: RATIO LOW ALARM	
Sequential Dosing System	
The mix ratio is lower than the set tolerance on the previous dose cycle.	
Dynamic Dosing System	
The mix ratio is lower than the set tolerance for an A to B component volume comparison.	
Cause	Solution
There is too much restriction in the system.	<ul style="list-style-type: none"> • Check that the system is fully loaded with material. • Check that the supply pump's cycle rate is set properly. • Check that the spray tip/nozzle is properly sized for the flow and application, and that it is not clogged. • Check that the fluid regulator is set properly.
If the alarm occurs during start up, after purging, the flow rate was probably too high.	Restrict gun needle travel to slow down the initial fluid delivery rate until fluid hoses are loaded with material.
If the alarm occurred after you were spraying for some time, the pressures from the fluid supplies could be unbalanced.	Adjust component A and B fluid supply regulator pressures until they are about equal. <i>If the pressures are already about equal</i> , verify that component A and B dose valves are operating properly.
Slow actuation of the component A or B valves. This can be caused by:	Manually operate the Dispense A and B solenoid valves as instructed in the ProMix 2KS Repair-Parts manual to check operation.
<ul style="list-style-type: none"> • Air pressure to the valve actuators is too low. 	<ul style="list-style-type: none"> • Increase air pressure. Air pressure must be 75-120 psi (0.52-0.84 MPa, 5.2-8.4 bar); 120 psi is recommended.
<ul style="list-style-type: none"> • Something is restricting the solenoid or tubing and interrupting valve actuation air. 	<ul style="list-style-type: none"> • There may be dirt or moisture in the air supply. Filter appropriately.
<ul style="list-style-type: none"> • A dose valve is turned in too far. 	<ul style="list-style-type: none"> • Refer to Table 7: Mix Manifold Valve Settings, page 55, for adjustment guidelines.
<ul style="list-style-type: none"> • Fluid pressure is high and air pressure is low. 	<ul style="list-style-type: none"> • Adjust air and fluid pressure. See recommended air pressure above.

Table 11. Alarm Troubleshooting

E-5: OVERDOSE A/B DOSE TOO SHORT ALARM and E-6: OVERDOSE B/A DOSE TOO SHORT ALARM	
E-5: the A dose overshoots and, when combined with B, is too large for the mix chamber capacity.	
E-6: the B dose overshoots and forces an A side dose that, when combined with B, is too large for the mix chamber capacity.	
Cause	Solution
Valve seal or needle/seat are leaking. Check FIG. 11 Totals Screen on page 25. If A and B are dosing simultaneously (sequential dosing only), there is a leak.	Repair the valve (see valve manual 312782).
Sampling valve is leaking.	Tighten or replace valve.
Flow meter fluctuations caused by pressure pulsations.	<p>Check for pressure pulsations:</p> <ol style="list-style-type: none"> 1. Close all the manifold valves. 2. Turn on the circulating pumps and all the booth equipment (such as fans and conveyors). 3. Check if the ProMix 2KS is reading any fluid flow. 4. If the ProMix 2KS shows there is fluid flow and there are no leaks from the gun or any other seals or fittings, the flow meters are probably being affected by pressure pulsations. 5. Close the fluid shutoff valve between the fluid supply system and the flow meter. The flow indication should stop. 6. If necessary, install pressure regulators or a surge tank on the fluid inlets to the ProMix 2KS to reduce the fluid supply pressure. Contact your Graco distributor for information.
Slow actuation of component A or B valves.	See E-3: RATIO HIGH ALARM and E-4: RATIO LOW ALARM , pages 84-85.
Running a high mix ratio and a high flow rate.	It may be necessary to restrict the flow rate through the component B dose valve by adjusting its hex nut (E). See page 53.

Table 11. Alarm Troubleshooting

E-7: DOSE TIME A ALARM and E-8: DOSE TIME B ALARM	
E-7: gun trigger input is active (AFS or Integration) and fewer than 31 A meter pulses were detected during the dose time selected.	
E-8: gun trigger input is active (AFS or Integration) and fewer than 31 B meter pulses were detected during the dose time selected.	
Cause	Solution
System is in Mix  mode and gun is only partially triggered, allowing air but no fluid to pass through gun.	Fully trigger the gun.
Fluid flow rate is too low.	Increase flow rate.
Dose time setting is too short for the current flow rate.	Increase the dose time setting.
Flow meter or cable failed or flow meter clogged.	<p>To check meter sensor operation, remove meter cap to expose sensor. Pass a ferrous metal tool in front of the sensor.</p> <div style="text-align: center;">  <p style="text-align: right;">T112792a</p> </div> <p>If there is a meter or cable failure, you will see a large difference between the amount of fluid dispensed and the flow meter volume displayed by the EasyKey. Clean or repair meter as necessary. Also see meter manual 308778.</p> <p>Follow Meter Calibration procedure, page 67.</p>
Slow actuation of component A or B valves.	See E-3: RATIO HIGH ALARM and E-4: RATIO LOW ALARM , pages 84-85.
The supply pump is not turned on.	Turn on the supply pump.
There is an air leak downstream from the air flow switch.	Check the air lines for leaks and repair.
The air flow switch is stuck open.	Clean or replace air flow switch.
System is in Mix mode with 0 volume entered for Min Material Fill Volume (see Option Screen 1 , page 34), and Fuse F1 is blown.	Verify condition of fuse and replace if necessary. See Repair-Parts manual.

Table 11. Alarm Troubleshooting

E-9: Not used	
E-10: REMOTE STOP ALARM	
Cause	Solution
Automation has requested that the system abort all operations.	Abort operations. Troubleshoot automation system.
E-11: PURGE VOLUME ALARM	
Cause	Solution
ProMix 2KS solvent flow switch is not activated while purging.	Verify that the gun is not shut off and that the solvent flow switch is activated while purge is taking place.
Minimum flush volume is not achieved.	Increase solvent supply or decrease minimum volume setting.
No meter pulses during Color/Catalyst Dump.	Color change solvent supply not set up or functional. Check Color Change setup.

Table 11. Alarm Troubleshooting

E-12: CAN COMM ERROR ALARM	
Cause	Solution
Communication between the Color Change Module and the Fluid Station is interrupted.	<ul style="list-style-type: none"> • Verify that all cables are connected securely and that the Color Change and Booth Control power LEDs turn on. If the power LED does not turn on, the problem is probably caused by a bad connection. The nut on the connector must make at least 5 complete turns to ensure a good connection. If the power LED still does not light, the cable or board is bad. • Check the color change board DIP switch settings. See the Installation manual. • Check the fluid plate board DIP switch setting. An incorrect setting will not cause E-12 alarms, but a correct setting will help prevent E-12 caused by electrical noise. See the Installation manual. • Check EasyKey software version (displayed at power up for all versions and when the lock key is pressed for version 2.02.000 and above). If older than 1.06.002, upgrade. Be sure to save settings through BWI or AWI before upgrading, as they will be erased. • The sticker on the color change board shows the software part number and version, for example 15T270 1.01. If the version is older than 1.01, replace the board. • If all software versions and DIP switch settings are correct and you still have E-12 alarms, then the system has a bad connection, bad cable, or bad circuit board. Use a multimeter on the CAN connectors to test whether there is a good connection between systems. If there is, you have a bad circuit board. If there is not, you have a bad connector, connection, or cable. • Appears on the EasyKey display if the unit is programmed for Manual Mode, and a booth control is not connected. • The dip switch settings on the Color Change Module were changed (see manual 312787) while the power was on. Cycle the power to clear the alarm. • The dip switch configuration on the Color Change Control Module (see manual 312787) is setup incorrectly.
Communication between the Color Change Module and the Fluid Station is interrupted. The fluid control board fuse is blown.	Verify condition of fuse and replace if necessary. See Repair-Parts manual.
Communication between the Booth Control and the Fluid Station is interrupted.	Verify that the cable is correctly connected.

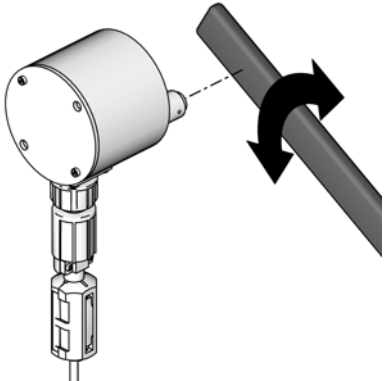
Table 11. Alarm Troubleshooting

E-13: HIGH FLOW ALARM or E-14: LOW FLOW ALARM (may also be set as Warnings)	
Cause	Solution
Fluid system is producing too much or too little flow.	Troubleshoot fluid system for restrictions, leaks, exhausted fluid supply, incorrect settings, etc. Increase or decrease flow rate, as required.
E-15: SYSTEM IDLE WARNING	
Cause	Solution
Mix input is high, but the gun has not been triggered for 2 minutes.	If not painting, clear alarm and resume operation. If painting, shut down and inspect fluid meter and air flow switch.
E-16: SETUP CHANGE WARNING	
Cause	Solution
The system setup parameters have been changed.	No action required. See Event Log available through advanced web interface.
E-17: POWER ON/POWER OFF WARNING	
Cause	Solution
The power to the system has been cycled.	No action required. See Event Log available through advanced web interface.
Voltage becoming too low due to weak power supply.	Replace power supply. See Repair-Parts manual.
Power wires are disconnected or making intermittent contact.	Check that all wires are securely connected. Ensure that wires are not stretched too tightly.
Reset button has been pushed (S1 on EasyKey display board, S3 on Autokey).	No action required. See Event Log available through advanced web interface.
Software update is initiated on EasyKey.	No action required. See Event Log available through advanced web interface.
E-18: DEFAULTS LOADED WARNING	
Cause	Solution
The factory defaults have been installed on the system.	No action required. See Event Log available through advanced web interface.

Table 11. Alarm Troubleshooting

E-19: I/O ALARM	
Cause	Solution
The Mix and Purge digital inputs are on at the same time.	Ensure that only one input is on at a time. At least 1 sec delay is required when switching from Mix to Purge or vice versa.
NOTE: The I/O alarm incorporates several sub-alarms relating to internal data issues, as detailed below. These alarms are only seen in the Alarm log or through BWI or AWI, and may not apply to all software versions.	
Fluid Plate Reboot (FP Reboot): Occurs if the system detects a fluid plate control board reboot or power cycle not triggered from the EasyKey. The system reverts to Recipe 61, and mixed material may be in the lines.	Flush the system or perform a color change. If possible, identify the origin of the reboot or power cycle.
Autokey Lost: Occurs if the Autokey is lost or changed after having been detected. (A short term loss of the Autokey will not be registered.) Some system functions may become unavailable. For example, an automatic system will not respond to PLC or robot control.	Reinstall the Autokey, or verify that the Autokey is set properly.
Illegal Source: Occurs if a recipe outside of the range 1-60 is detected as the source data for global recipe data copies. This is possible if an invalid configuration file is sent to the EasyKey.	Verify that the source data is from a valid recipe (1-60).
2K/3K Error: Occurs if the recipe data is incompatible with the current Autokey setting (2K or 3K). This is possible if the Autokey is changed or an invalid configuration file is sent to the EasyKey.	Verify that the Autokey is set properly or that the configuration file is valid.
Init Error: Occurs if the recipe data codes specifying the type of machine they were made on are not what is expected. For example, a 3KS machine receives a configuration file originally made on a 2KS machine.	Verify that the configuration file is valid.
Config Error: Occurs if a configuration file sent to the EasyKey specifies a different hardware setup than what exists. For example, the configuration file specifies 2 color change boards but only 1 is present.	Verify that the configuration file specifications and the hardware conform.
Range Error: Occurs if a valve used in a recipe is not present in the current hardware setup. For example, a recipe calls for valve 30 but the system has only 12 valves.	Verify that the recipe specifications and the hardware conform.
Level Control (LC) Error: Occurs if level control data is received by the EasyKey, and the current Autokey setting (2K or 3K) has changed since the level control data was originally initialized.	Verify that the Autokey is set properly.
Level Control (LC) Range Error: Occurs if level control data includes a valve range exceeding the capability of the machine.	Set level control data correctly.
Modbus (MB) Overflow: Occurs if the Modbus connection to a PLC experiences data overflow.	Verify the Modbus protocol to the EasyKey.

Table 11. Alarm Troubleshooting

E-20: PURGE INITIATE ALARM	
Cause	Solution
System detects atomizing air to the gun when purge is selected.	Shut off gun air.
For systems with a gun flush box, gun is not in the box when purge is selected.	Place gun in gun flush box. Verify that gun flush box is operating properly.
For systems with auto dump on, gun is not in the box when auto dump is initiated.	Place gun in gun flush box. Verify that gun flush box is operating properly.
For systems with a gun flush box, Fuse F2 is blown.	Verify condition of fuse and replace if necessary. See Repair-Parts manual.
E-21: MATERIAL FILL ALARM	
Cause	Solution
For systems with minimum mixed material fill volume entered, the system detects that fill volume is not achieved during mixed material fill time.	<p>Check for restrictions or leaks in the fluid supply system.</p> <p>Check if the fill volume is properly configured:</p> <ul style="list-style-type: none"> • Adjust fill volume. • Adjust fill time.
For systems without color change and with minimum mixed material fill volume entered, Fuse F1 is blown.	Verify condition of fuse and replace if necessary. See Repair-Parts manual.
E-22: TANK A LOW ALARM, E-23: TANK B LOW ALARM, or E-24: TANK S LOW ALARM	
Cause	Solution
The tank volume reaches the low-level threshold.	<p>The EasyKey screen will display the alarm and prompt the user to do one of the following:</p> <ul style="list-style-type: none"> • Refill tank volume to clear the alarm. • Resume mixing by selecting "Spray 25% of remaining volume." If this selection is chosen, a second alarm will occur after 25% of the remaining volume is mixed. Refill tank volume to clear the alarm.

Table 11. Alarm Troubleshooting

E-25: AUTO DUMP COMPLETE ALARM	
Cause	Solution
A potlife alarm is active for more than 2 minutes, the gun flush box is enabled and gun is in the gun flush box, and an auto dump flush sequence is complete.	Be sure to spray all mixed material before potlife expires.
E-26: COLOR/CATALYST PURGE ALARM	
Cause	Solution
System detects no meter pulses, or a disruption in meter pulses lasting longer than 1 second throughout the Color/Catalyst purge time duration.	Check that meter cable is connected. Clean or repair meter.
E-27: COLOR/CATALYST FILL ALARM	
Cause	Solution
System detects no meter pulses, or system must detect at least 10cc of material from each side throughout the Color/Catalyst fill time duration.	Check that meter cable is connected. Clean or repair meter.
Gun, dump valve, or correct color/catalyst valve not open.	Open the valve.
Exhausted fluid supply.	Check fluid level and refill if necessary.
Switch settings (S3-S6) on color change board do not match hardware configuration.	Verify that color change board switches are set correctly. See installation manual.
Fuse F1, F2, or both are blown.	Verify condition of fuses and replace if necessary. See Repair-Parts manual.
E-28: MIX FILL PUSH COMPLETE	
Cause	Solution
Mix fill push has been completed.	Potlife expired material has been purged.

Schematic Diagrams

System Pneumatic Schematic

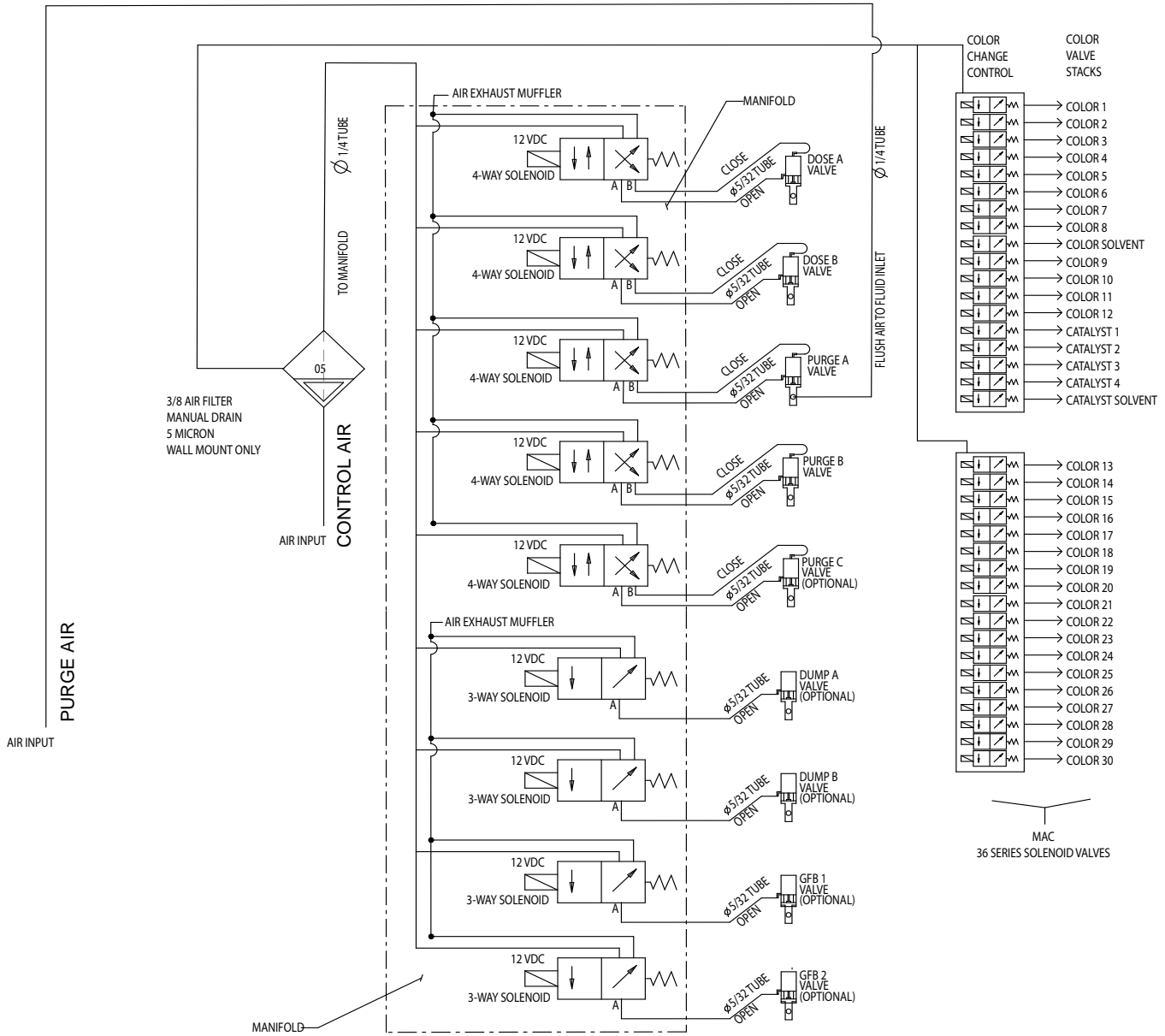

System Electrical Schematic

NOTE: The electrical schematic illustrates all possible wiring expansions in a ProMix 2KS system. Some components shown are not included with all systems.

Non-Hazardous Area

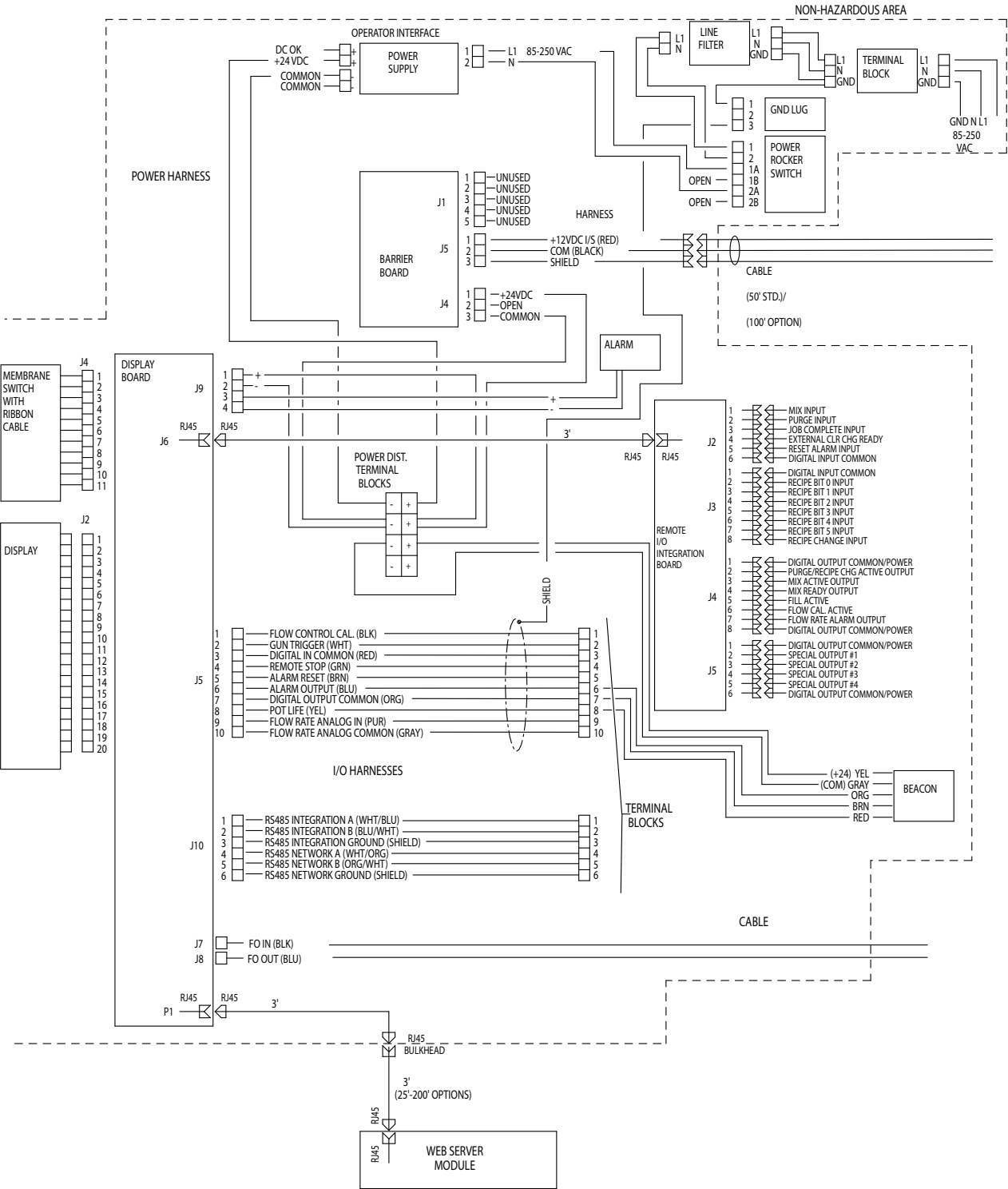

System Electrical Schematic

NOTE: The electrical schematic illustrates all possible wiring expansions in a ProMix 2KS system. Some components shown are not included with all systems.

Hazardous Area

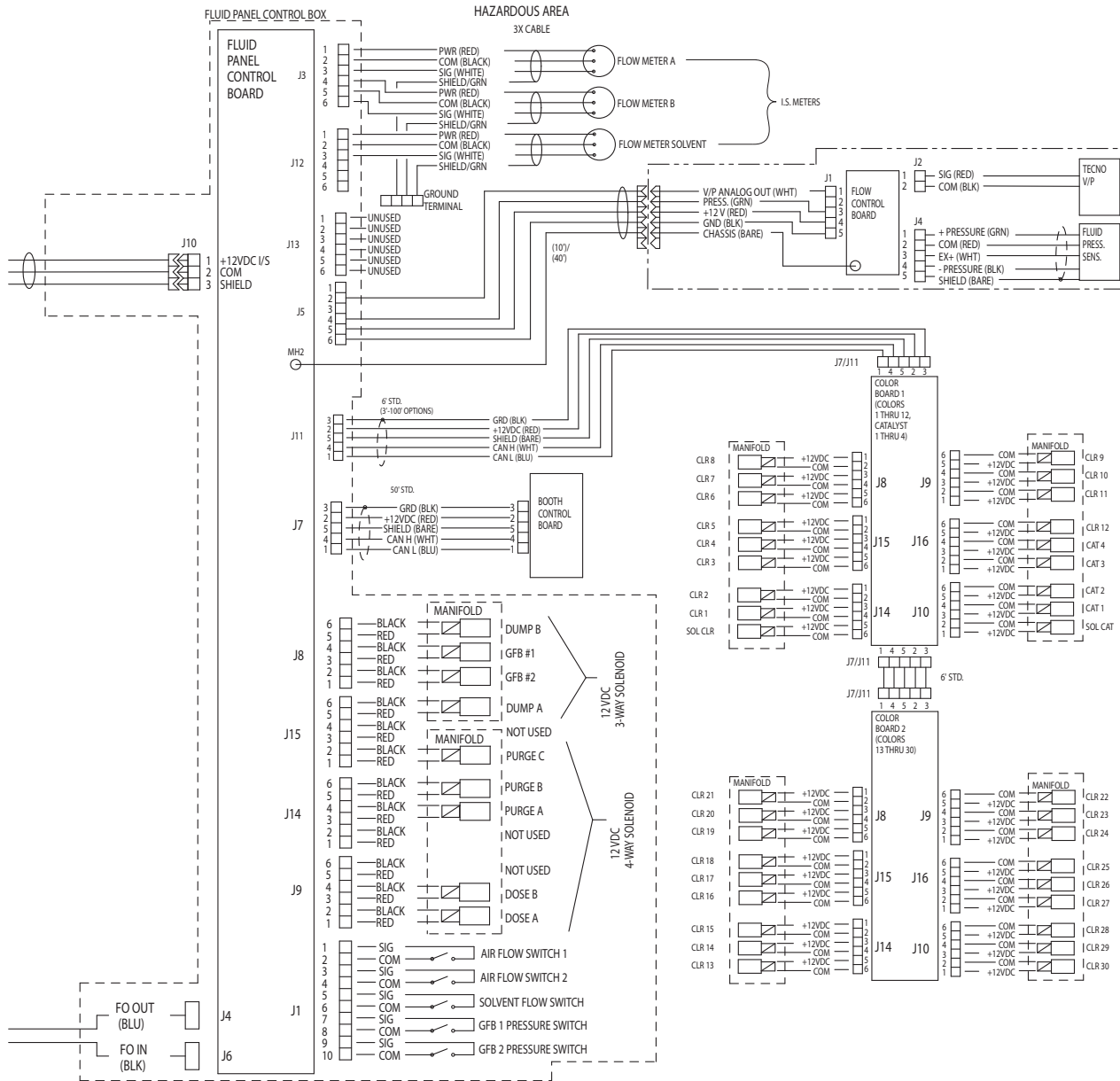

EasyKey Electrical Schematic

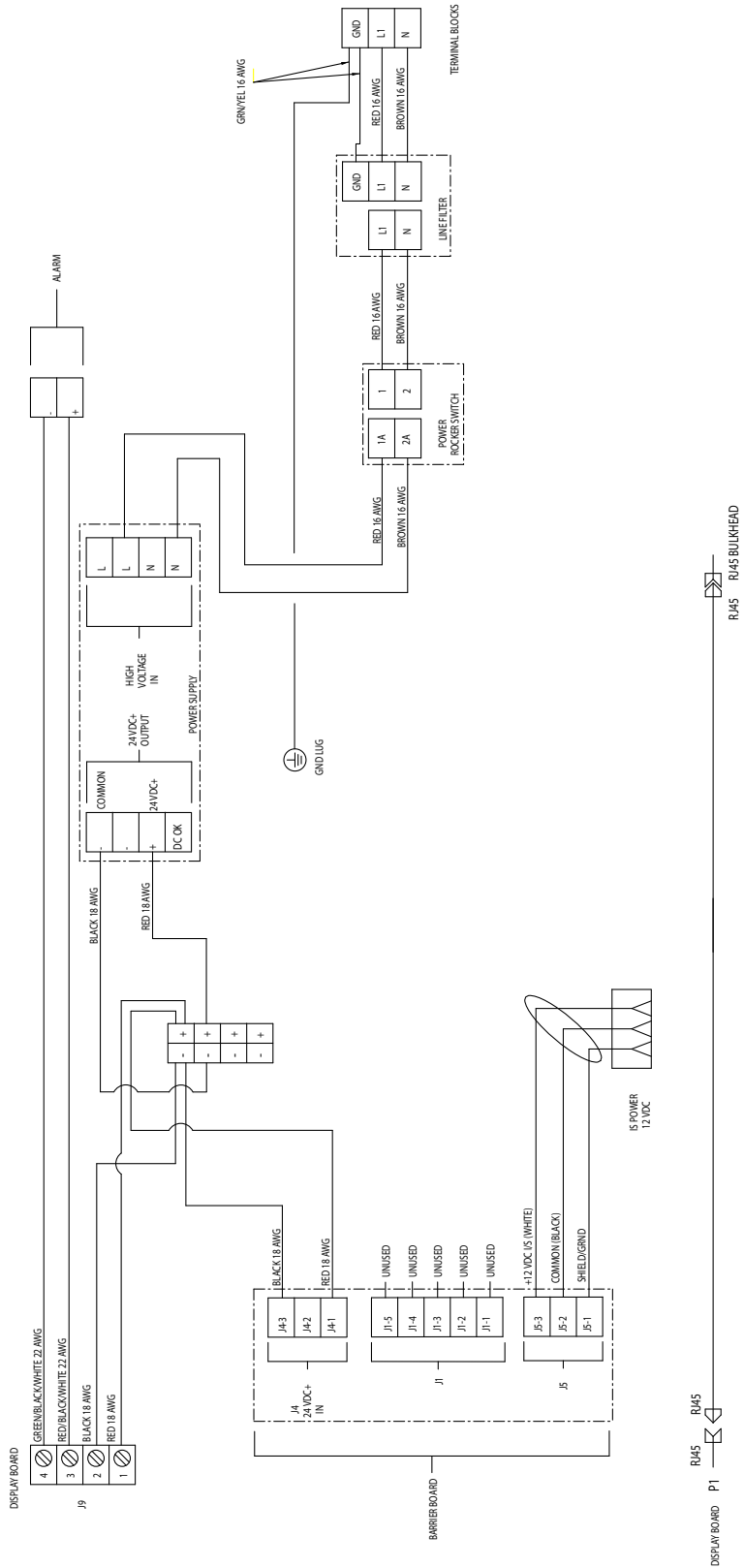

Meter Performance Data (G3000 on A and B)

NOTE: Maximum system flow is 3800 cc/min.

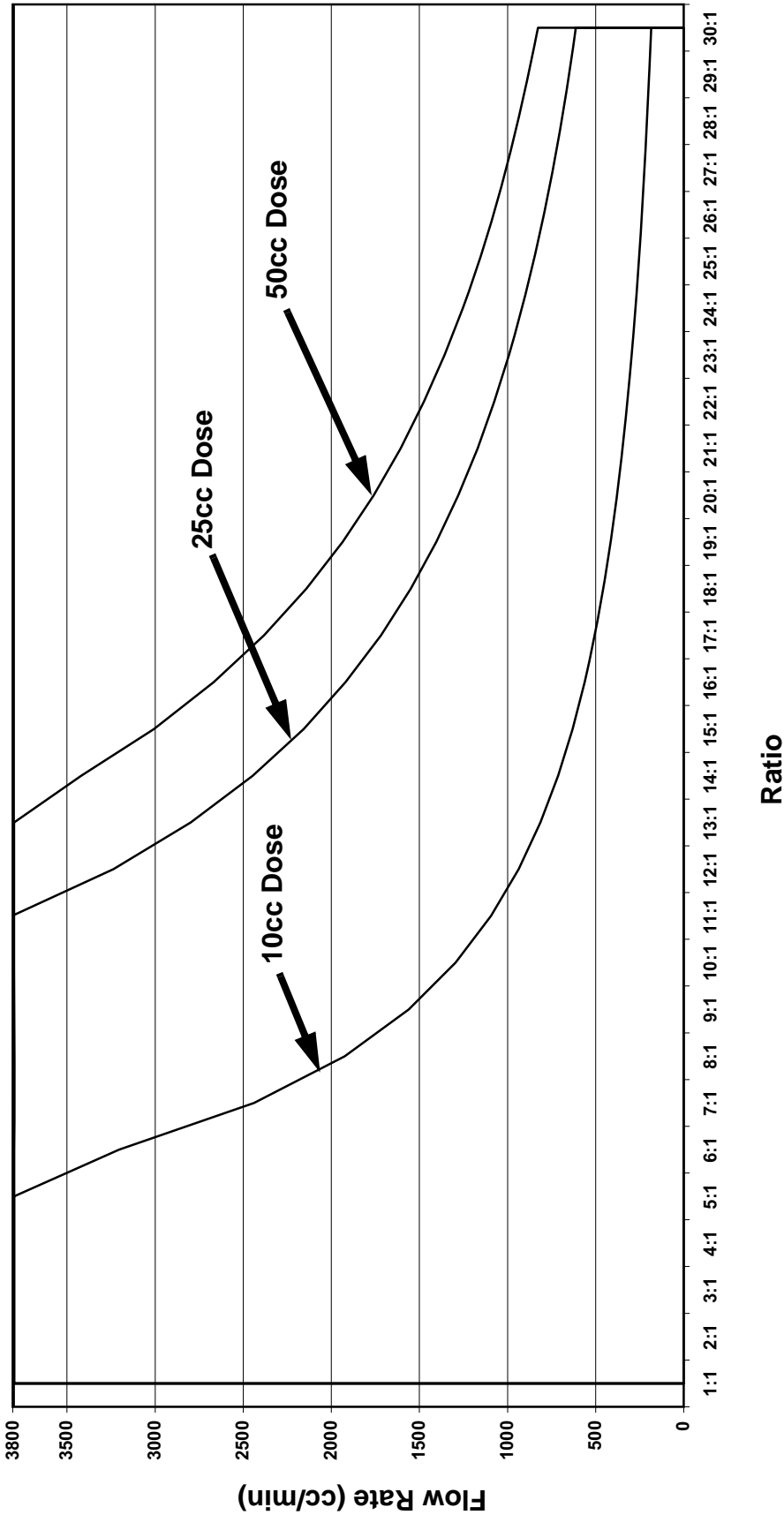

Test Conditions
Fluid: Hydraulic Oil
Viscosity: 65.7 centipoise
Ratio Tolerance: 5%
Valve Setting: 1.25 Turns Open (standard setting)
A and B Feed Pressure: 300 psig

Meter Performance Data (G3000 on A, Coriolis on B)

NOTE: Maximum system flow is 3800 cc/min.

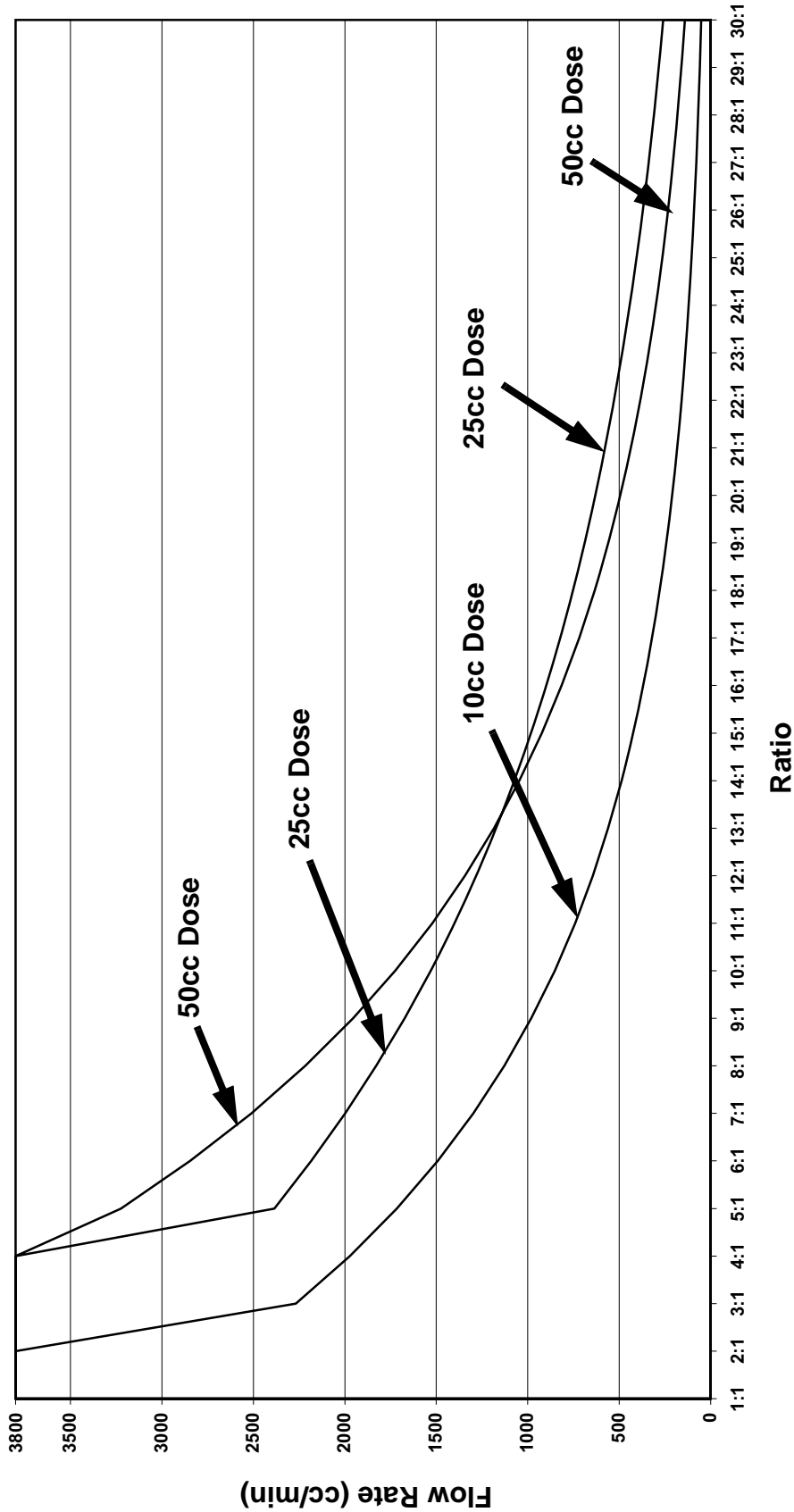

Test Conditions
Fluid: Hydraulic Oil
Viscosity: 65.7 centipoise
Ratio Tolerance: 5%
Valve Setting: 1.25 Turns Open (standard setting)
A and B Feed Pressure: 300 psig

Technical Data

Maximum fluid working pressure	<i>Base system:</i> 4000 psi (28 MPa, 280 bar) <i>Low pressure color change:</i> 300 psi (2.1 MPa, 21 bar) <i>High pressure color change:</i> 3000 psi (21 MPa, 210 bar) <i>Coriolis meter:</i> 2300 psi (16.1 MPa, 161 bar)
Maximum working air pressure	100 psi (0.7 MPa, 7 bar)
Air supply	75 - 100 psi (0.5 - 0.7 MPa, 5.2 - 7 bar)
Air filter inlet size	3/8 npt(f)
Air filtration for air logic and purge air (Graco-supplied) . .	5 micron (minimum) filtration required; clean and dry air
Air filtration for atomizing air (user-supplied)	30 micron (minimum) filtration required; clean and dry air
Mixing ratio range	0.1:1- 50:1*
On-ratio accuracy	up to \pm 1%, user selectable
Fluids handled	one or two component: <ul style="list-style-type: none"> • solvent and waterborne paints • polyurethanes • epoxies • acid catalyzed varnishes • moisture sensitive isocyanates
Viscosity range of fluid	20- 5000 cps*
Fluid filtration (user-supplied)	100 mesh minimum
Fluid flow rate range*	
G3000, G250, G3000A Meter	75 - 3800 cc/min. (0.02-1.00 gal./min.)
G3000HR, G250HR Meter	38 - 1900 cc/min. (0.01-0.50 gal./min.)
Coriolis Meter	20 - 3800 cc/min. (0.005-1.00 gal./min.)
S3000 Solvent Meter (accessory)	38 - 1900 cc/min. (0.01-0.50 gal./min.)
Fluid inlet sizes	
Flow Meter	1/4 npt(f)
Dose Valve/Color Valve Adapters	1/4 npt(f)
Fluid outlet size (static mixer)	1/4 npt(f)
External Power Supply Requirements	85 - 250 Vac, 50/60 Hz, 2 amps maximum draw 15 amp maximum circuit breaker required 8 to 14 AWG power supply wire gauge
Operating temperature range	41- 122° F (5-50° C)
Environmental Conditions Rating	indoor use, pollution degree (2), installation category II
Noise Level	
Sound pressure level	below 70 dBA
Sound power level	below 85 dBA
Wetted parts	303, 304 SST, Tungsten carbide (with nickel binder), perfluoroelastomer; PTFE
Wetted materials on acid models (ME1001 - ME1004)	316, 17-4 SST; PEEK, perfluoroelastomer; PTFE

* Dependent on programmed K-factor and application. The maximum allowable flow meter pulse frequency is 425 Hz (pulses/sec). For more detailed information on viscosities, flow rates, or mixing ratios, consult your Graco distributor.

See individual component manuals for additional technical data.

Graco Standard Warranty

Graco warrants all equipment referenced in this document which is manufactured by Graco and bearing its name to be free from defects in material and workmanship on the date of sale to the original purchaser for use. With the exception of any special, extended, or limited warranty published by Graco, Graco will, for a period of twelve months from the date of sale, repair or replace any part of the equipment determined by Graco to be defective. This warranty applies only when the equipment is installed, operated and maintained in accordance with Graco's written recommendations.

This warranty does not cover, and Graco shall not be liable for general wear and tear, or any malfunction, damage or wear caused by faulty installation, misapplication, abrasion, corrosion, inadequate or improper maintenance, negligence, accident, tampering, or substitution of non-Graco component parts. Nor shall Graco be liable for malfunction, damage or wear caused by the incompatibility of Graco equipment with structures, accessories, equipment or materials not supplied by Graco, or the improper design, manufacture, installation, operation or maintenance of structures, accessories, equipment or materials not supplied by Graco.

This warranty is conditioned upon the prepaid return of the equipment claimed to be defective to an authorized Graco distributor for verification of the claimed defect. If the claimed defect is verified, Graco will repair or replace free of charge any defective parts. The equipment will be returned to the original purchaser transportation prepaid. If inspection of the equipment does not disclose any defect in material or workmanship, repairs will be made at a reasonable charge, which charges may include the costs of parts, labor, and transportation.

THIS WARRANTY IS EXCLUSIVE, AND IS IN LIEU OF ANY OTHER WARRANTIES, EXPRESS OR IMPLIED, INCLUDING BUT NOT LIMITED TO WARRANTY OF MERCHANTABILITY OR WARRANTY OF FITNESS FOR A PARTICULAR PURPOSE.

Graco's sole obligation and buyer's sole remedy for any breach of warranty shall be as set forth above. The buyer agrees that no other remedy (including, but not limited to, incidental or consequential damages for lost profits, lost sales, injury to person or property, or any other incidental or consequential loss) shall be available. Any action for breach of warranty must be brought within two (2) years of the date of sale.

GRACO MAKES NO WARRANTY, AND DISCLAIMS ALL IMPLIED WARRANTIES OF MERCHANTABILITY AND FITNESS FOR A PARTICULAR PURPOSE, IN CONNECTION WITH ACCESSORIES, EQUIPMENT, MATERIALS OR COMPONENTS SOLD BUT NOT MANUFACTURED BY GRACO. These items sold, but not manufactured by Graco (such as electric motors, switches, hose, etc.), are subject to the warranty, if any, of their manufacturer. Graco will provide purchaser with reasonable assistance in making any claim for breach of these warranties.

In no event will Graco be liable for indirect, incidental, special or consequential damages resulting from Graco supplying equipment hereunder, or the furnishing, performance, or use of any products or other goods sold hereto, whether due to a breach of contract, breach of warranty, the negligence of Graco, or otherwise.

FOR GRACO CANADA CUSTOMERS

The Parties acknowledge that they have required that the present document, as well as all documents, notices and legal proceedings entered into, given or instituted pursuant hereto or relating directly or indirectly hereto, be drawn up in English. Les parties reconnaissent avoir convenu que la rédaction du présente document sera en Anglais, ainsi que tous documents, avis et procédures judiciaires exécutés, donnés ou intentés, à la suite de ou en rapport, directement ou indirectement, avec les procédures concernées.

Graco Information

For the latest information about Graco products, visit www.graco.com.

For patent information, see www.graco.com/patents.

TO PLACE AN ORDER, contact your Graco distributor or call to identify the nearest distributor.

Phone: 612-623-6921 **or Toll Free:** 1-800-328-0211 **Fax:** 612-378-3505

*All written and visual data contained in this document reflects the latest product information available at the time of publication.
Graco reserves the right to make changes at any time without notice.*

Original instructions. This manual contains English. MM 312776

Graco Headquarters: Minneapolis

International Offices: Belgium, China, Japan, Korea

GRACO INC. AND SUBSIDIARIES • P.O. BOX 1441 • MINNEAPOLIS MN 55440-1441 • USA

Copyright 2008, Graco Inc. All Graco manufacturing locations are registered to ISO 9001.

www.graco.com
Revision L 03/2019