

## Pro Xpc™ Auto Controller

333266L  
EN

For controlling the Graco Pro Xpc Auto Electrostatic Spray Guns. For professional use only.  
Not approved for use in explosive atmospheres or hazardous locations.



### Important Safety Instructions

Read all warnings and instructions in this manual and in your Pro Xpc™ Auto Electrostatic Air Spray Gun manual. **Save these instructions.**

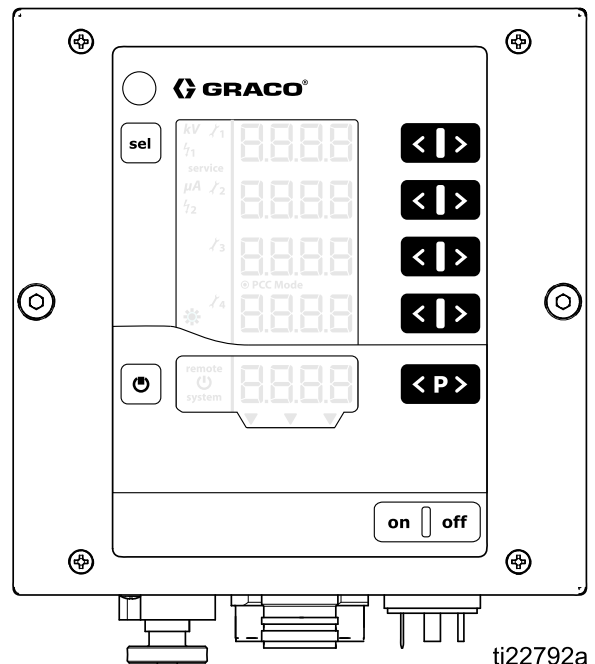

# Contents







Models.....	3	Screen Areas.....	35
Approved System Components .....	3	Icons.....	35
Related Manuals .....	3	Input Keys and Switches .....	36
Warnings .....	4	Additional Features .....	36
Introduction .....	6	Setup.....	38
Controller Features and Options .....	6	Setup Screen 0 (System Type) .....	40
Installation.....	7	Setup Screen 1 (Electrostatics Control Mode).....	40
Interlocks.....	7	Setup Screen 2 (Remote Interface) .....	41
Installation Options .....	8	Setup Screen 3 (Analog Input Type Select) .....	42
No Integration .....	9	Setup Screen 4 (Analog Output Type Select) .....	42
Basic Integration .....	10	Setup Screen 6 (CAN Purpose ID) .....	43
PLC Integration.....	11	Setup Screen 7 (Log Level) .....	43
Pre-Installation Steps.....	12	Setup Screen 8 (Averaging Interval).....	44
Ventilate the Spray Booth .....	12	Setup Screen 9 (Blanking Time).....	44
Install the Pro Xpc Auto Spray Gun .....	12	Setup Screen 10 (Discharge Time).....	45
Interlock Waterborne Isolation Enclosure.....	12	Setup Screen 11 (Transition Time).....	45
Mount the Controller .....	13	Operation.....	46
Location .....	13	System Startup .....	46
Mounting .....	13	Presets.....	46
Grounding .....	14	Run Screen 1 (Electrostatics Readings) .....	47
Controller Connections.....	15	Run Screen 2 (Arc Limits).....	48
Overview .....	15	Run Screen 3 (Maintenance Counters) .....	49
Connections .....	16	Arc Detection.....	50
Discrete I/O.....	18	Screen Map.....	53
Isolation .....	18	Troubleshooting.....	56
I/O Grounding .....	18	Error Codes.....	56
REMOTE Input Operation.....	18	Gun Power Cable Continuity.....	59
REMOTE Output Operation.....	18	Repair.....	60
Signals.....	19	Power Board Fuse Replacement.....	60
Analog Inputs .....	23	Main Circuit Board, Power Board, LED Panel, or Keypad Membrane Removal .....	61
Analog Outputs.....	23	Power Board Removal .....	65
Digital Inputs.....	24	Software Update .....	66
Digital Outputs.....	24	Parts.....	67
Discrete I/O Interface Connections .....	24	Dimensions .....	68
Operation Modes and Timing Diagrams .....	25	Technical Specifications.....	71
Standby Mode .....	26		
SAFE POSITION Mode .....	27		
Spray .....	29		
Error Handling .....	31		
Purge.....	33		
Controller Display and Features.....	35		

## Models

Controller	Controller Series	Description	Maximum Gun Voltage Output
24Y307	D	Pro Xpc Auto Controller, solventborne	100 kV
24Y308	D	Pro Xpc Auto Controller, waterborne	60 kV

## Approved System Components

Specific controllers, guns, and gun power cables must be used together. Refer to the table below for compatible models.







Controller	Gun Models	Gun Power Cables	Product Type	Controller Approvals
24Y307	LC1020 LC2020	17H040 17H041 17H042	Solvent-borne	  II 3(2)G T6 PTB 15 ATEX 5013 EN 50050-1, EN 50176  RECOGNIZED COMPONENT  Intertek 9902471 Conforms to UL STD 61010-1 and UL STD 61010-2-201 Cert. to CSA STD C22.2#61010-1 and CSA/IEC STD 61010-2-201:2014
24Y308	LC1028 LC2028	17H040 17H041 17H042	Waterborne	 RECOGNIZED COMPONENT  Intertek 9902471 Conforms to UL STD 61010-1 and UL STD 61010-2-201 Cert. to CSA STD C22.2#61010-1 and CSA/IEC STD 61010-2-201:2014







## Related Manuals

Manual No.	Description
332992	Pro Xpc Auto Electrostatic Air Spray Gun

# Warnings

The following warnings are for the setup, use, grounding, maintenance, and repair of this equipment. The exclamation point symbol alerts you to a general warning and the hazard symbols refer to procedure-specific risks. When these symbols appear in the body of this manual or on warning labels, refer back to these Warnings. Product-specific hazard symbols and warnings not covered in this section may appear throughout the body of this manual where applicable.

 <h2 style="margin: 0;">WARNING</h2>	
   	<p><b>FIRE AND EXPLOSION HAZARD</b></p> <p>Flammable fumes, such as solvent and paint fumes, in work location can ignite or explode. Paint or solvent flowing through the system can cause static sparking. To help prevent fire or explosion:</p> <ul style="list-style-type: none"> <li>• Electrostatic equipment must be used only by trained, qualified personnel who understand the requirements of this manual.</li> <li>• Ground all equipment, personnel, object being sprayed, and conductive objects in or close to the spray location. Resistance must not exceed 1 megohm. See <b>Grounding</b> instructions.</li> <li>• Do not use pail liners unless they are conductive and grounded.</li> <li>• <b>Stop operation immediately</b> if static sparking occurs. Do not use equipment until you identify and correct the problem.</li> <li>• Check gun resistance and electrical grounding daily.</li> <li>• Use and clean equipment only in a well ventilated location.</li> <li>• Never spray or flush solvent at high pressure.</li> <li>• Always turn the electrostatics off when flushing, cleaning, or servicing equipment.</li> <li>• Eliminate all ignition sources; such as pilot lights, cigarettes, portable electric lamps, and plastic drop cloths (potential static arc).</li> <li>• Do not plug or unplug power cords or turn lights on or off when flammable fumes are present.</li> <li>• Keep spray location free of debris, including solvent, rags, and gasoline.</li> <li>• Keep a working fire extinguisher in the work location.</li> </ul> <p><b>For solventborne systems only:</b></p> <ul style="list-style-type: none"> <li>• Use cleaning solvents with highest possible flash point when flushing or cleaning equipment.</li> </ul> <p><b>For waterborne systems only:</b></p> <ul style="list-style-type: none"> <li>• Do not spray or clean with flammable materials. Use water-based materials only.</li> </ul>
 	<p><b>ELECTRIC SHOCK HAZARD</b></p> <p>This equipment must be grounded. Improper grounding, setup, or usage of the system can cause electric shock.</p> <ul style="list-style-type: none"> <li>• Turn off and disconnect power at main switch before disconnecting any cables and before servicing or installing equipment.</li> <li>• Connect only to grounded power source.</li> <li>• All electrical wiring must be done by a qualified electrician and comply with all local codes and regulations.</li> </ul>

 <h1 style="margin: 0;">WARNING</h1>	
 	<p><b>EQUIPMENT MISUSE HAZARD</b></p> <p>Misuse can cause death or serious injury.</p> <ul style="list-style-type: none"> <li>• Do not operate the unit when fatigued or under the influence of drugs or alcohol.</li> <li>• Do not exceed the maximum working pressure or temperature rating of the lowest rated system component. See <b>Technical Specifications</b> in all equipment manuals.</li> <li>• Use fluids and solvents that are compatible with equipment wetted parts. See <b>Technical Specifications</b> in all equipment manuals. Read fluid and solvent manufacturer's warnings. For complete information about your material, request the Safety Data Sheet (SDS) from distributor or retailer.</li> <li>• Turn off all equipment and follow the <b>Pressure Relief Procedure</b> when equipment is not in use.</li> <li>• Check equipment daily. Repair or replace worn or damaged parts immediately with genuine manufacturer's replacement parts only.</li> <li>• Do not alter or modify equipment. Alterations or modifications may void agency approvals and create safety hazards.</li> <li>• Make sure all equipment is rated and approved for the environment in which you are using it.</li> <li>• Use equipment only for its intended purpose. Call your distributor for information.</li> <li>• Route hoses and cables away from traffic areas, sharp edges, moving parts, and hot surfaces.</li> <li>• Do not kink or over bend hoses or use hoses to pull equipment.</li> <li>• Keep children and animals away from work location.</li> <li>• Comply with all applicable safety regulations.</li> </ul>
	<p><b>TOXIC FLUID OR FUMES</b></p> <p>Toxic fluids or fumes can cause serious injury or death if splashed in the eyes or on the skin, inhaled, or swallowed.</p> <ul style="list-style-type: none"> <li>• Read the Safety Data Sheet (SDS) to know the specific hazards of the fluids you are using.</li> <li>• Store hazardous fluid in approved containers, and dispose of it according to applicable guidelines.</li> </ul>
 	<p><b>PLASTIC PARTS CLEANING SOLVENT HAZARD</b></p> <p>Many solvents can degrade plastic parts and cause them to fail, which could cause serious injury or property damage.</p> <ul style="list-style-type: none"> <li>• Use only compatible water-based solvents to clean plastic structural or pressure-containing parts.</li> <li>• See <b>Technical Specifications</b> in this and all other equipment instruction manuals. Read fluid and solvent manufacturer's Safety Data Sheet (SDS) and recommendations.</li> </ul>
	<p><b>PERSONAL PROTECTIVE EQUIPMENT</b></p> <p>Wear appropriate protective equipment when in the work location to help prevent serious injury, including eye injury, hearing loss, inhalation of toxic fumes, and burns. This protective equipment includes but is not limited to:</p> <ul style="list-style-type: none"> <li>• Protective eyewear, and hearing protection.</li> <li>• Respirators, protective clothing, and gloves as recommended by the fluid and solvent manufacturer.</li> </ul>

## Introduction

The Pro Xpc Auto Controller is designed exclusively for controlling a Graco electrostatic spray gun as part of a paint coating system.

The controller sends power to the gun power supply, which increases the voltage to the level set at the controller. The fluid is charged by the spray gun electrode. The charged fluid is attracted to the nearest grounded object, wrapping around and evenly coating all surfaces.

## Controller Features and Options

- The full voltage setting is 100 kV for solventborne guns and 60 kV for waterborne guns.
- The controller can be flush mounted at the front plate or wall mounted. See [Mounting, page 13](#).

The Pro Xpc Auto Controller provides the ability to:

- Display and set the voltage and current.
- Create and store spray presets.
- Operate the spray gun remotely via discrete I/O or Graco CAN.

The controller has three interlocks. These interlocks must be satisfied before the system will operate. Check and follow all National, State, and Local codes regarding properly interlocking your spray system. Also see [Ventilate the Spray Booth, page 12](#).

# Installation

## Interlocks

Interlocks are required to ensure that the system is safe to operate. The controller can use internal or external signals to receive verification that the conditions the interlocks are monitoring are in a state that is safe for the system to operate.

Xpc Auto Controller for each interlock. The table also explains how to bypass the interlock if the requirement is being satisfied in another manner.

If other forms of interlock are implemented that preclude the need to use the controller interlocks, the controller interlocks can be disabled.

Determine how the following interlocks will be used. The following table shows how to use the Pro

Interlock	Pin	Description
System Interlock	Input power cord, Pin 3 (wire 3)	<p>Pin 3 on the Input Power Connection requires line voltage to be applied for electrostatics to activate. See Step 2 in <a href="#">Connections, page 16</a>.</p> <p>If not required, bypass the interlock by connecting wire 3 to line voltage on the Input Power cord. The <b>system</b> icon is displayed on the controller screen when the System Interlock is satisfied. See <a href="#">Screen Areas, page 35</a>.</p>
24VDC Interlock	Discrete I/O cable, pin 19	<p>Pin 19 on the Discrete I/O Cable Connection requires 24VDC to be applied for electrostatics to activate. This pin can be used to connect to an external device, such as a ventilation interlock signal to the controller. Input signal values are:</p> <p>0 (0VDC or GND): Interlock not satisfied; electrostatics disabled</p> <p>1 (24VDC): interlock satisfied; electrostatics activation is not locked by this input.</p> <p>If not required, apply a constant 24VDC to Pin 19, or see <a href="#">Disable Controller Interlocks, page 8</a>.</p> <p>Symbol A9 on the display screen (see <a href="#">Screen Areas, page 35</a>) will show that this signal is satisfied.</p>
SAFE POSITION Interlock	Discrete I/O cable, pin 18	<p>Pin 18 on the Discrete I/O Cable Connection requires 24VDC to be applied for electrostatics to activate. Apply only when the applicator is in SAFE POSITION. See <a href="#">SAFE POSITION Mode, page 27</a>. If electrostatics are on, removing 24VDC from this pin will not deactivate the electrostatics.</p> <p>0 (0VDC or GND): Interlock not satisfied; If electrostatics are off, electrostatics disabled. If electrostatics are on, no change to electrostatics.</p> <p>1 (24VDC): Interlock satisfied; electrostatics activation is not locked by this input.</p> <p>If not required, apply a constant 24VDC to Pin 18, or see <a href="#">Disable Controller Interlocks, page 8</a>.</p> <p>Symbol A10 on the display screen (see <a href="#">Screen Areas, page 35</a>) will show that this signal is satisfied.</p>

## Disable Controller Interlocks

If interlock requirements have been satisfied in your system by means other than the Pro Xpc Auto Controller, the controller interlocks can be disabled.

1. To disable the system interlock, connect wire 3 on the controller input power cord to line voltage. The **system** icon will be lit on the display screen.
2. Remove power from the controller.
3. Remove 4 screws and take off the access cover.

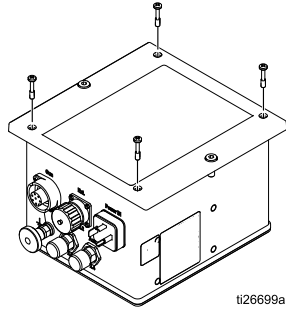

4. Locate the interlock switches on the main board. When the switches are in the ON position, the interlocks are considered satisfied.

Switch 1 is the 24VDC Interlock (pin 19 on the Discrete I/O cable). Switch 2 is the SAFE POSITION Interlock (Pin 18 on the Discrete I/O cable).

Symbols in A9 and A10 (see [Screen Areas, page 35](#)) on the display screen will show that these signals are satisfied.

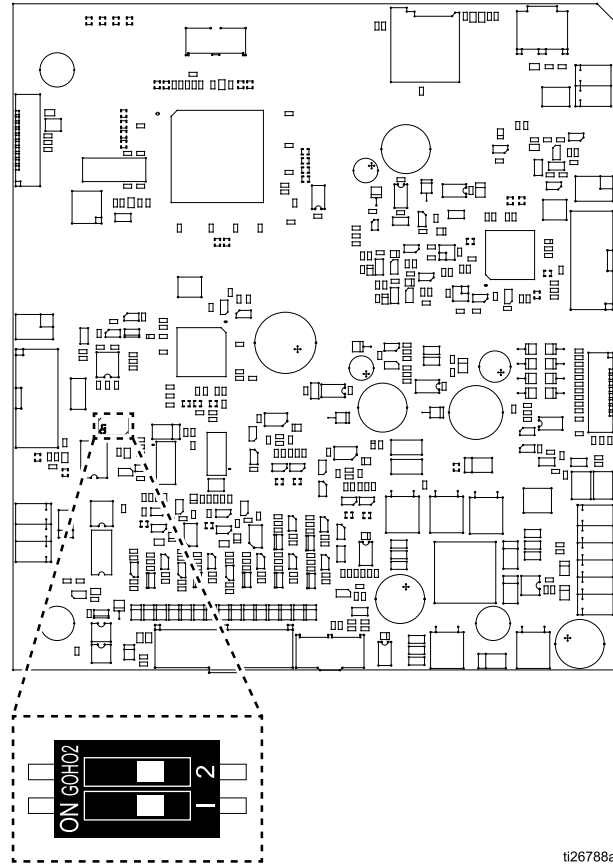

Switches shown in OFF position.

## Installation Options

Installation details vary widely depending on the system requirements. This section shows three typical installations. They are not actual system designs. For assistance in designing a system to suit your particular needs, contact your Graco distributor.



<p>Installing and servicing this equipment requires access to parts which may cause fire, explosion, electric shock or other serious injury if work is not performed properly.</p> <ul style="list-style-type: none"> <li>• Do not install or service this equipment unless you are trained and qualified.</li> <li>• Be sure your installation complies with national, state, and local codes for the installation of electrical apparatus in a Class I, Division 1, or a Group II, Zone 1 Hazardous Location.</li> <li>• Comply with all applicable local, state, and national fire, electrical, and other safety regulations.</li> </ul>				



## No Integration

The defining characteristics of a No Integration installation include:

- No integration of the Pro Xpc Auto Air Spray Gun or Controller.
- Local operation using the Pro Xpc Auto Controller interface.
- Interlocks managed independently of the spray gun installation.

				
<p>To reduce the risk of fire and explosion, the controller (B) must be electrically interlocked with the spray booth ventilation fans to prevent the gun from operating without ventilation fans operating.</p>				

### Non-Hazardous Location

### Hazardous Location

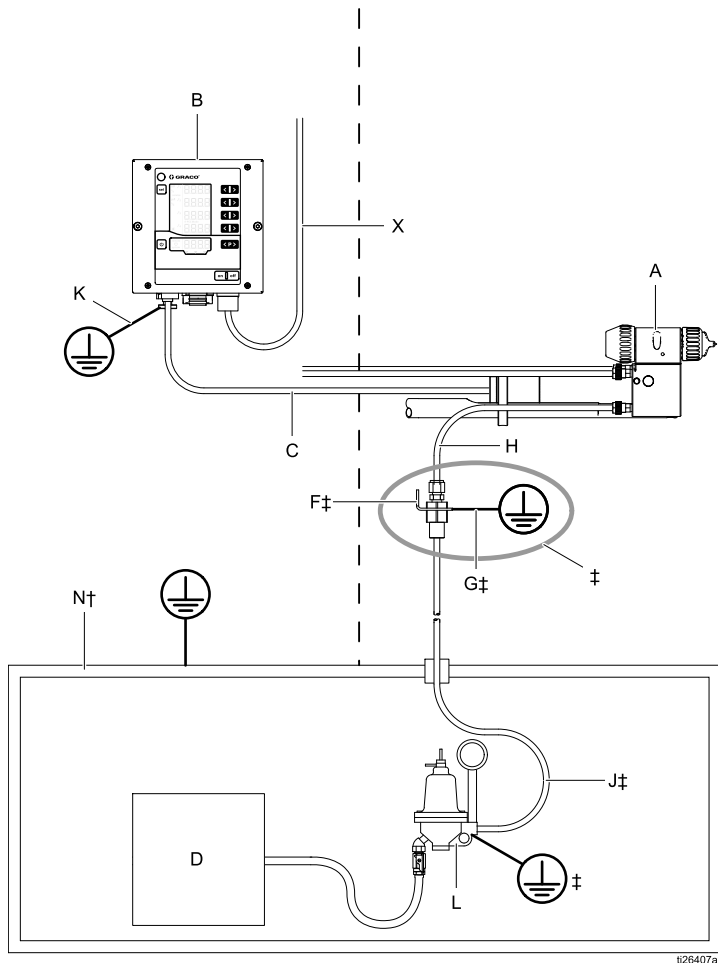

Typical Installation With No Integration

### KEY:

<b>A</b>	Pro Xpc Auto Air Spray Gun
<b>B</b>	Pro Xpc Auto Controller
<b>C</b>	Gun Power Cable
<b>D</b>	Fluid Supply
<b>F‡</b>	Fluid Hose Ground Bracket
<b>G‡</b>	Fluid Bracket Ground Wire
<b>H</b>	‡Fluid Supply Tube (Graco-supplied) to gun fluid inlet, maximum 8 ft (2.4 m) length †Graco Waterborne Fluid Supply Hose, from fluid regulator (L) to gun inlet (hose must be a single, uninterrupted length).
<b>J‡</b>	Fluid Supply Hose
<b>K</b>	Pro Xpc Auto Controller Ground Wire
<b>L</b>	Fluid Regulator
<b>N†</b>	Isolation Enclosure
<b>X</b>	Pro Xpc Auto Controller Power Cord

†Waterborne systems only

‡Solventborne systems only

## Basic Integration



The defining characteristics of a Basic Integration installation include:

- Integration of basic gun and controller functions.
- Integration of controller interlocks.
- Local operation of setup and error functions.

This example shows a basic integration using 6, of the available 19, signals available on the Discrete I/O cable.

- **Preset Select 1 (Pin 1) and Preset Select 2 (Pin 2):** Used to select Presets P000-P003. For example: Select Preset P002 by applying 24V to Pin 2 and Ground or no connection to Pin 1.
- **Remote Enable/Disable (Pin 4):** Enable remote control through the Discrete I/O interface by applying 24V to Pin 4.

- **Electrostatic Enable (Pin 5):** Use a switched voltage source for Pin 5 to activate/trigger the electrostatics.
- **GND (Pins 8, 12, 17):** Used as ground reference for I/O signals.
- **Interlocks:** See [Interlocks, page 7](#), for information on how to set up the required interlocks.

				
To reduce the risk of fire and explosion, the controller (B) must be electrically interlocked with the spray booth ventilation fans to prevent the gun from operating without ventilation fans operating.				

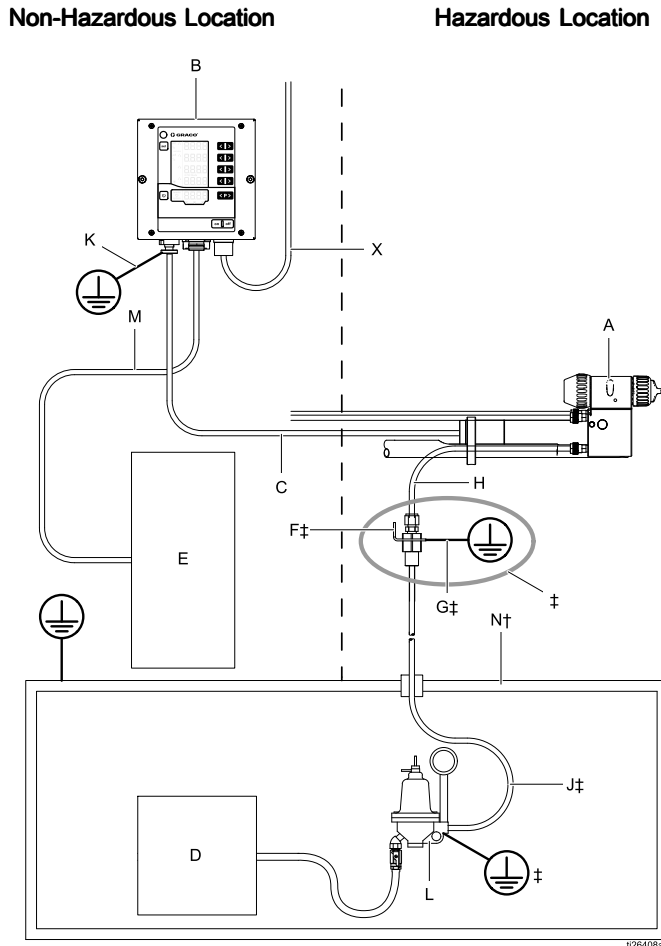

**KEY:**

<b>A</b>	Pro Xpc Auto Air Spray Gun
<b>B</b>	Pro Xpc Auto Controller
<b>C</b>	Gun Power Cable
<b>D</b>	Fluid Supply
<b>E</b>	Discrete I/O Signals
<b>F‡</b>	Fluid Hose Ground Bracket
<b>G‡</b>	Fluid Bracket Ground Wire
<b>H</b>	‡Fluid Supply Tube (Graco-supplied) to gun fluid inlet, maximum 8 ft (2.4 m) length †Graco Waterborne Fluid Supply Hose, from fluid regulator (L) to gun inlet (hose must be a single, uninterrupted length).
<b>J‡</b>	Fluid Supply Hose
<b>K</b>	Pro Xpc Auto Controller Ground Wire
<b>L</b>	Fluid Regulator
<b>M</b>	Discrete I/O Cable
<b>N†</b>	Isolation Enclosure
<b>X</b>	Pro Xpc Auto Controller Power Cord

†Waterborne systems only  
‡Solventborne systems only



Typical Installation With Basic Integration

## PLC Integration

The defining characteristics of a PLC (Programmable Logic Controller) Integration installation include:

- PLC integration of all gun and controller functions.

See [Discrete I/O, page 18](#), for a complete description of the signals.

				
<p>To reduce the risk of fire and explosion, the controller (B) must be electrically interlocked with the spray booth ventilation fans to prevent the gun from operating without ventilation fans operating.</p>				

### Non-Hazardous Location

### Hazardous Location

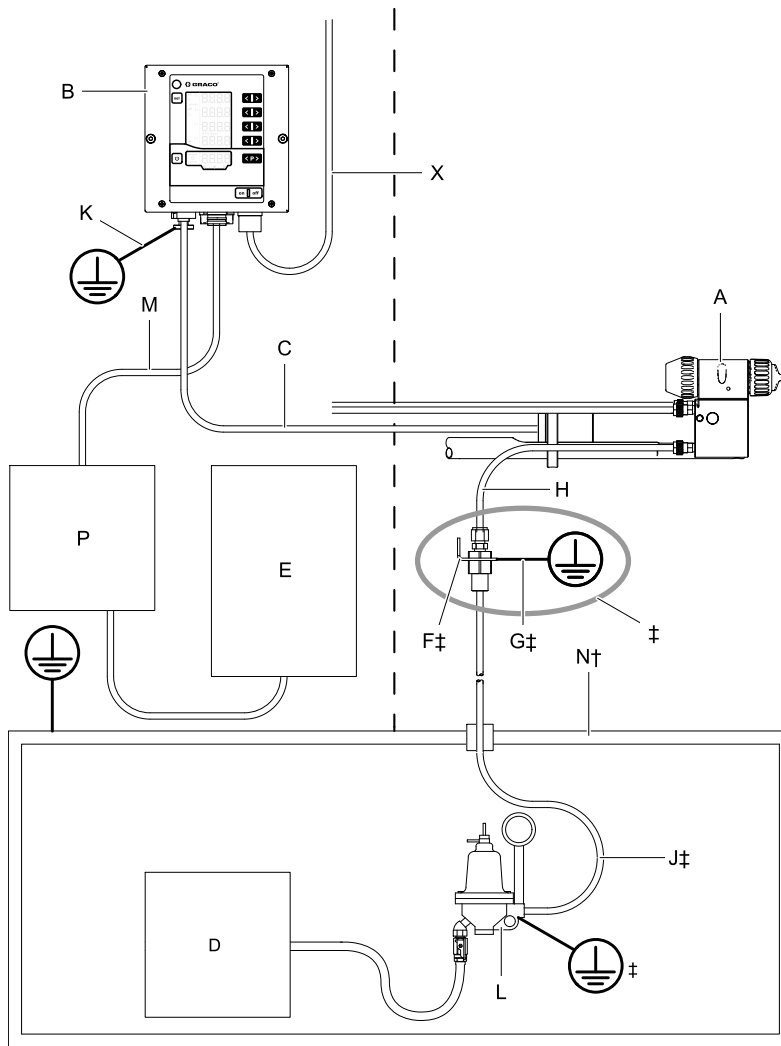

Typical Installation With PLC Integration

#### KEY:

<b>A</b>	Pro Xpc Auto Air Spray Gun
<b>B</b>	Pro Xpc Auto Controller
<b>C</b>	Gun Power Cable
<b>D</b>	Fluid Supply
<b>E</b>	Robot or Reciprocator
<b>F‡</b>	Fluid Hose Ground Bracket
<b>G‡</b>	Fluid Bracket Ground Wire
<b>H</b>	‡Fluid Supply Tube (Graco-supplied) to gun fluid inlet, maximum 8 ft (2.4 m) length †Graco Waterborne Fluid Supply Hose, from fluid regulator (L) to gun inlet (hose must be a single, uninterrupted length).
<b>J‡</b>	Fluid Supply Hose
<b>K</b>	Pro Xpc Auto Controller Ground Wire
<b>L</b>	Fluid Regulator
<b>M</b>	Discrete I/O Cable
<b>N†</b>	Isolation Enclosure
<b>P</b>	PLC
<b>X</b>	Pro Xpc Auto Controller Power Cord

†Waterborne systems only

‡Solventborne systems only

# Pre-Installation Steps

## Ventilate the Spray Booth

				
<p>Provide fresh air ventilation to avoid the buildup of flammable or toxic vapors when spraying, flushing, or cleaning the gun. Do not operate the gun unless ventilation fans are operating.</p>				



Electrically interlock the controller (B) with the ventilators to prevent gun operation without ventilating fans operating. Use the 24 VDC Interlock pin on the Discrete I/O cable to connect to the ventilator interlock. Check and follow all National, State, and Local codes regarding air exhaust velocity requirements.

**NOTE:** High velocity air exhaust will decrease the operating efficiency of the electrostatic system. The minimum allowable air exhaust velocity is 60 ft/minute (19 linear meters/minute).

## Install the Pro Xpc Auto Spray Gun



See the Pro Xpc Auto Air Spray Gun Manual (332992) for installation instructions.

## Interlock Waterborne Isolation Enclosure

				
<p>To reduce the risk of electric shock, interlock the controller with the voltage isolation system to shut off the electrostatics anytime the isolation system enclosure is opened.</p>				

For information about the interlocks and their use, see [Interlocks, page 7](#).

# Mount the Controller

				
<p>To reduce the risk of fire or explosion, do not install equipment approved only for a non-hazardous location in a hazardous location.</p>				

## Location

Install the Pro Xpc Auto Controller in a non-hazardous location only.

## Mounting

The Pro Xpc Auto Controller can be flush mounted at the front plate or wall mounted.

### Wall Mount (Flat Panel)

An optional method of mounting the controller is to use a panel with a cutout and mounting holes.

1. See [Dimensions, page 68](#).
2. Determine the mounting location. Ensure that the location will support the mounting panel and the controller.
3. Prepare the panel by cutting out the opening and preparing the mounting holes for the controller:
  - a. If the two controller front panel screws are to be used to attach the controller to the panel, the panel holes will require tapping threads, or providing some other sort of threaded fastener, such as PEM nuts on the panel.
  - b. If an alternative fastener will be used, it may be necessary to back out the two threaded fasteners from the controller front cover so that the mounting hardware can use the existing controller front panel mounting holes.



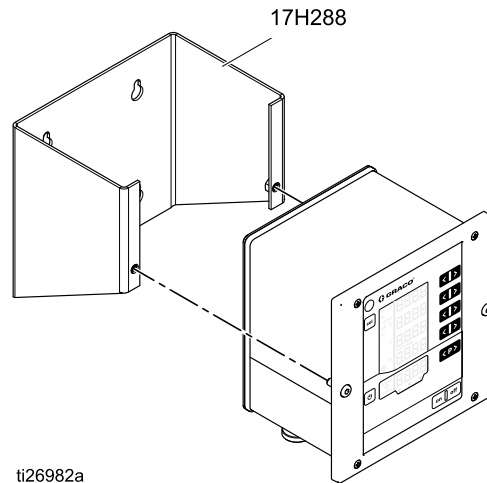

### Wall Mount (Mounting Bracket)

An optional wall mount bracket (17H288) is available to mount the controller on any flat wall.

1. See [Dimensions, page 68](#).
2. Determine mounting location. Ensure that the wall is strong enough to support the weight of the mounting bracket and the controller.
3. Position the mounting bracket on the wall and mark mounting holes using the plate of the bracket as a template.
4. Drill holes and attach the mounting bracket to the wall.
5. Attach the controller to the wall mount bracket using two 6 mm screws (provided).



## Grounding

				
<p>When operating the electrostatic gun, any ungrounded objects in the spray location (people, containers, tools, etc.) can become electrically charged. Improper grounding can result in static sparking, which can cause a fire, explosion, or electric shock. Ground all equipment, personnel, object being sprayed, and conductive objects in or close to the spray location. Follow the grounding instructions below.</p>				

The following are minimum grounding requirements for a basic electrostatic system. Your system may include other equipment or objects which must be grounded. Check your local electrical code for detailed grounding instructions. Your system must be connected to a true earth ground.

- *Pro Xpc Auto Controller:* Ground the Pro Xpc Auto Controller with a grounded power cord and grounded socket. Also ground the controller with the ground connection and ground wire.
- *Pump:* ground the pump by connecting a ground wire and clamp as described in your separate pump instruction manual.
- *Fluid Bracket (for solventborne systems only):* ground the fluid bracket by connecting the bracket ground wire to a true earth ground. Mount the fluid bracket a distance behind the gun that can be reached by a hose with a maximum length of 8 ft (2.4 m).
- *Fluid Tube (for solventborne systems only):* ground the fluid tube by connecting it to the grounded fluid bracket.
- *Fluid Hose (for waterborne systems only):* the hose is grounded through the conductive layer. Install the hose as instructed in the gun manual.
- *Electrostatic Air Spray Gun:* ground the gun by connecting the gun power cable to a properly grounded controller.
- *Air compressors and hydraulic power supplies:* ground the equipment according to the manufacturer's recommendations.
- *All electrical cables* must be properly grounded.
- *All persons entering the spray location:* shoes must have conductive soles, such as leather; or personal grounding straps must be worn. Do not wear shoes with non-conductive soles such as rubber or plastic.
- *Object being sprayed:* keep the workpiece hangers clean and grounded at all times. Resistance must not exceed 1 megohm.
- *The floor of the spray location:* must be electrically conductive and grounded. Do not cover the floor with cardboard or any non-conductive material which would interrupt ground continuity.
- *Flammable liquids in the spray location:* must be kept in approved, grounded containers. Do not use plastic containers. Do not store more than the quantity needed for one shift.
- *All electrically conductive objects or devices in the spray location:* including fluid containers and wash cans, must be properly grounded.

# Controller Connections

## Overview

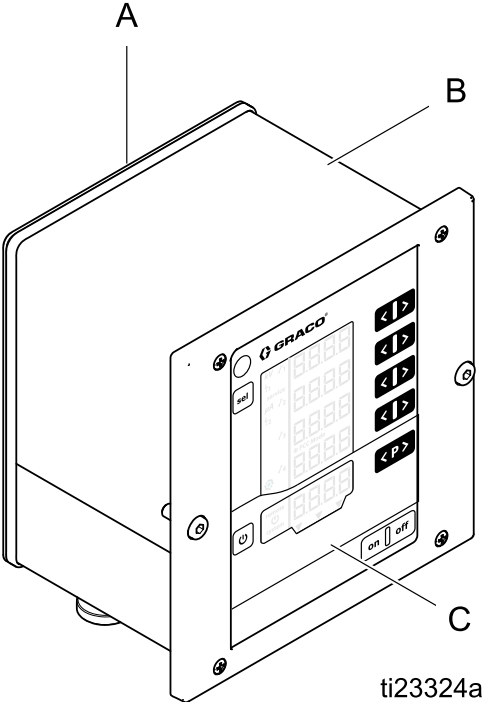

ti23324a

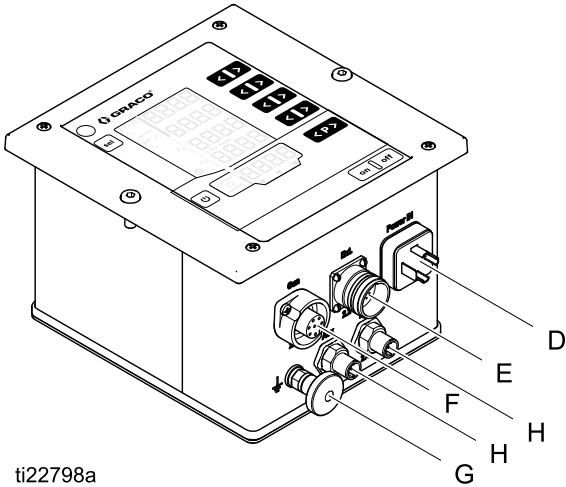

ti22798a

A	Back panel
B	Enclosure
C	Front Plate with control and display elements

D	Input Power Connection
E	Discrete I/O Cable Connection — use in a system that requires integration
F	Gun Power Cable Connection
G	Ground Connection
H	CAN Connection

## Connections

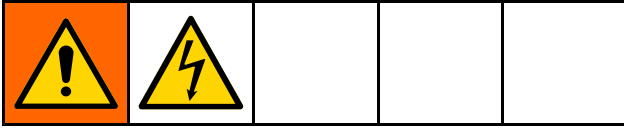

1. Connect the ground wire to the ground connection (G). Connect the other end to a true earth ground. This connection is required for all installations.
2. Connect the supplied controller input power cord to the input power connection (D) and secure with

the connector screw. This connection is required for all installations. The controller can operate at 100–240 VAC (50–60 Hz). Connect the leads to a power source according to local electrical codes. Pin 3 on the input power connection is the system interlock. Pin 3 must have line voltage applied to satisfy the system interlock. When the system interlock pin is connected to line voltage, the **system** icon will appear on the controller. See [Screen Areas, page 35](#).

Controller Input Power Connection		Pin No.	Function	Wire Marking
		1	Neutral conductor power supply	1
		2	Phase (100-240 VAC)	2
		3	System Interlock ON/OFF (100-240 VAC) = ON	3
		PE	Grounding PE	Green/Yellow

3. Connect the 7-pin end of the gun power cable to the gun power cable connection (F) on the controller. Connect the 4-pin end of the gun power cable to the spray gun. Follow instructions

in the gun manual. This connection is required for all installations.

Controller		Gun	
Connector (F)	Cable	Cable	Power Supply Connector

Electrical Schematic for this cable:

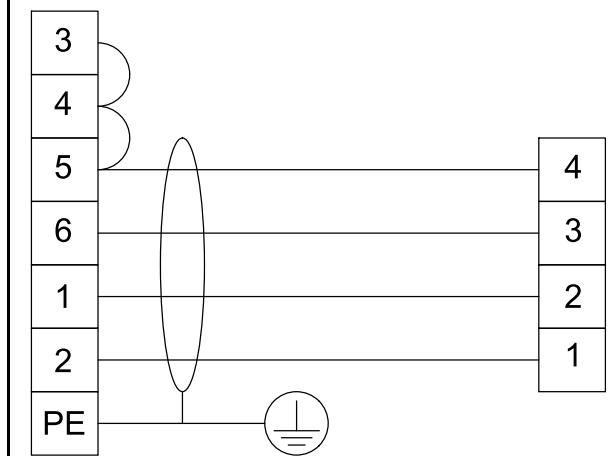



- Connect the Discrete I/O cable to the Discrete I/O cable connection (E) on the controller. The Discrete I/O cable is required for any installation that involves integration. Two discrete I/O interlock connections are supplied and must be satisfied. (See [Interlocks, page 7](#) ) See [Discrete I/O, page 18](#) for a more detailed explanation of each pin.

Discrete I/O cable Connection			
<p><b>Controller</b></p> <p><b>Cable</b></p>	<b>Pin No.</b>	<b>Function</b>	<b>Wire Color</b>
	1	Preset Select 1	White
	2	Preset Select 2	Brown
	3	Error Reset	Green
	4	Remote Enable/Disable	Yellow
	5	Electrostatics Enable	Gray
	6	Safe-to-Move Output	Pink
	7	Error Output	Blue
	8	I/O Ground	Red
	9	Current Setpoint Input	Black
	10	Voltage Setpoint Input	Purple
	11	Reserved Input	Gray/Pink
	12	I/O Ground	Red/Blue
	13	Actual Spraying Current Output	White/Green
	14	Actual Spraying Voltage Output	Brown/Green
	15	Electrostatic Discharge	White/Yellow
	16	Analog Output External Power (24 VDC)	Yellow/Brown
	17	I/O Ground	White/Gray
	18	SAFE POSITION Interlock Input	Gray/Brown
19	24VDC Interlock Input	Pink/Brown and Pink/White	

See [Discrete I/O, page 18](#) for more information.

- Connect the Graco CAN cables to the CAN cable connections (H) on the controller. CAN communication is required for remote operation with Graco modules to allow remote configuration and operation of the controller.

**NOTE:** CAN communication is Graco proprietary and will not work with other types of CAN.

## Discrete I/O

The controller can accept up to 19 I/O interface signals. Systems can be designed to integrate from 1 signal up to all 19 signals. The examples in this manual describe a basic integration (6 I/O signals used) and a complex integration (all 19 I/O signals used).

Discrete I/O input signals are only monitored if the Pro Xpc Auto Controller has been placed in the Discrete I/O mode. See [Setup Screen 2 \(Remote Interface\), page 41](#).

See [Signals, page 19](#) for available signals.

### Isolation

The discrete I/O interface signals are isolated from circuit ground. Isolation is required to prevent disturbance of the measurement of the spraying current.

**NOTE:** The isolation is not designed to isolate hazardous potentials.

### I/O Grounding

Pins 8, 12, and 17 are the I/O Ground pins. Connect a ground from each connecting device to one or more of these pins. This will match the potential of the Pro Xpc Auto Controller and the connecting device.

## REMOTE Input Operation

In order to accept remote input commands from the discrete I/O interface, the following conditions must be met:

- The discrete I/O interface must be selected by setting Parameter P02 = 1. See [Setup Screen 2 \(Remote Interface\), page 41](#).
- The REMOTE Enable input, on the Discrete I/O cable, pin 4, must have 24VDC (logical "1") applied to it to select REMOTE mode.

Connect the desired input signals. During REMOTE input operation, error confirmation is the only local input (using the keypad) possible.

**NOTE:** Values for presets P001 – P003 must be set up prior to entering REMOTE mode. Preset P000 is the only preset which can be altered using the Discrete I/O cable signals when the controller has been placed in REMOTE mode. Presets P004 - P250 are not accessible in REMOTE mode.

## REMOTE Output Operation

Connect the desired signals. Digital output signals are generated unconditionally. Analog output signals require 24VDC on Analog Output External Power (pin 16) on the discrete I/O Interface cable.

## Signals

**Note on Digital Inputs and Outputs:** A “0 (or Low)” is used to indicate that GND or no signal is present. A “1 (or High)” is used to indicate that a 24 VDC signal is present.

Pin	Type	Description															
1	Digital Input	<p><b>Preset Select 1 (Pin 1) and Preset Select 2 (Pin 2)</b></p> <p>Use to specify the Preset selection in REMOTE operation through the discrete I/O interface:</p> <table border="1"> <thead> <tr> <th>Pin 2</th> <th>Pin 1</th> <th></th> </tr> </thead> <tbody> <tr> <td>0</td> <td>0</td> <td>Preset P000</td> </tr> <tr> <td>0</td> <td>1</td> <td>Preset P001</td> </tr> <tr> <td>1</td> <td>0</td> <td>Preset P002</td> </tr> <tr> <td>1</td> <td>1</td> <td>Preset P003</td> </tr> </tbody> </table> <p>In REMOTE mode, the values for Preset P000 are based on the analog signals received on the discrete I/O interface. These values will overwrite any existing values in Preset P000.</p> <p>The values for Presets P001–P003 must be entered locally, using the keypad, prior to placing the controller in REMOTE mode. It is not possible to change the values of these Presets remotely.</p> <p>Presets P004–P250 are not accessible in REMOTE mode.</p>	Pin 2	Pin 1		0	0	Preset P000	0	1	Preset P001	1	0	Preset P002	1	1	Preset P003
Pin 2	Pin 1																
0	0	Preset P000															
0	1	Preset P001															
1	0	Preset P002															
1	1	Preset P003															
2	Digital Input																
3	Digital Input	<p><b>Error Reset</b></p> <p>Use to allow error codes to be acknowledged remotely. Acknowledging an error code does not correct the condition that created the error.</p> <p>0→1 transition: Reset all reported errors</p> <p><b>NOTE:</b> Additional errors will be logged, regardless of the state of the Error reset. To perform additional error resets, transition from 0 to 1 again.</p>															
4	Digital Input	<p><b>REMOTE Enable/Disable</b></p> <p>Use to enable or disable REMOTE operation. Enabling REMOTE operation locks out local control and allows the controller to use the discrete I/O interface. When enabled, the <b>remote</b> icon on the display is shown.</p> <p>0: Local control 1: REMOTE control</p>															
5	Digital Input	<p><b>Electrostatic Enable</b></p> <p>Use to enable or disable electrostatics output.</p> <p>0: Disable electrostatics. 1: Enable electrostatics. All other conditions for activating the electrostatics must be met.</p>															

Pin	Type	Description
6	Digital Output	<p><b>Safe-to-Move Output</b></p> <p>Indicates whether the applicator can be moved out of SAFE POSITION to begin paint application. This output is tied to the arc detection blanking time setting on <i>Setup Screen 9</i>. The blanking timer begins counting down when high voltage is enabled. When the timer has reached zero, the Safe-to-Move Output is switched from 0 to 1.</p> <p>0: Applicator must not be moved out of SAFE POSITION because arc detection is blanked and electrostatics are activated.</p> <p>1: Applicator allowed to be moved out of SAFE POSITION because arc detection is effective or electrostatics are deactivated.</p> <p>For more information, see <a href="#">SAFE POSITION Mode, page 27</a>.</p>
7	Digital Output	<p><b>Error Output</b></p> <p>Used to signal detection of an error condition.</p> <p>0: No error condition detected.</p> <p>1: An error condition has been detected and reported.</p> <p><b>NOTE:</b> Reset by Error Reset input or by local confirmation.</p>
8	Ground	<p><b>I/O Ground</b></p> <p>Reference potential for I/O interface signals.</p>
9	Analog Input	<p><b>Current Setpoint Input</b></p> <p>Use to set the current setpoint (<math>\mu\text{A}</math>) nominal value. The REMOTE current setpoint input applies when Preset 0 (P000) is selected and the controller is in REMOTE operation.</p> <p>This signal is used to create the current setting in P000. The larger the input value, the greater the electrostatics current setpoint.</p> <p>0 – 10 V (received input) <math>\rightarrow</math> 0 – 150 <math>\mu\text{A}</math> (desired gun output)</p> <p>OR</p> <p>4 – 20 mA (received input) <math>\rightarrow</math> 0 – 150 <math>\mu\text{A}</math> (desired gun output)</p> <p>The type of input is selected on <a href="#">Setup Screen 3 (Analog Input Type Select), page 42</a></p>
10	Analog Input	<p><b>Voltage Setpoint Input</b></p> <p>Use to set the voltage setpoint (kV) nominal value. The REMOTE voltage setpoint input applies when Preset 0 (P000) is selected and the controller is in REMOTE operation.</p> <p>The input voltage or current is used to create a relational output voltage value for the gun electrostatics power supply. The larger the input value, the greater the electrostatics voltage at the gun.</p> <p>0 – 10V (received input) <math>\rightarrow</math> 0 – <i>max kV*</i> (desired gun output)</p> <p>OR</p> <p>4 – 20mA (received input) <math>\rightarrow</math> 0 – <i>max kV*</i> (desired gun output)</p> <p>The type of input is selected on <a href="#">Setup Screen 3 (Analog Input Type Select), page 42</a></p> <p>* <i>max kV</i> = 100 kV (solventborne) or 60 kV (waterborne)</p>
11	Digital Input	Reserved for future use.
12	Ground	<p><b>I/O Ground</b></p> <p>Reference potential for discrete I/O interface signals.</p>

Pin	Type	Description
13	Analog Output	<p><b>Actual Spraying Current Output</b></p> <p>Use to indicate the actual spraying current (0 – 150 <math>\mu</math>A). 24 VDC must be applied to Pin 16 to enable this function.</p> <p>The voltage or current signal present on this pin is proportional to the spraying current of the electrostatic power supply. The larger the value on this pin, the greater the output current at the gun.</p> <p>0 – 150 <math>\mu</math>A (gun output) <math>\rightarrow</math> 0 – 10V or 4 – 20 mA (pin output)</p> <p>The type of output is selected on <a href="#">Setup Screen 4 (Analog Output Type Select)</a>, page 42</p>
14	Analog Output	<p><b>Actual Spraying Voltage Output</b></p> <p>Use to indicate the actual spraying voltage (0– <i>max kV</i>*). 24 VDC must be applied to Pin 16 to enable this function.</p> <p>The voltage or current signal present on this pin is proportional to the spraying voltage of the electrostatic power supply. The larger the value on this pin, the greater the output voltage at the gun.</p> <p>0 – <i>max kV</i>*(gun output) <math>\rightarrow</math> 0 – 10V or 4 – 20 mA (pin output)</p> <p>The type of output is selected on <a href="#">Setup Screen 4 (Analog Output Type Select)</a>, page 42</p> <p>* <i>max kV</i>= 100 kV (solventborne) or 60 kV (waterborne)</p>
15	Digital Output	<p><b>Electrostatic Discharge Output</b></p> <p>Use to indicate when electrostatics have been fully discharged. Set the electrostatic discharge time setting on <i>Setup Screen 10</i> (Configuration C2). The discharge timer begins counting down when electrostatics have been disabled. When the timer reaches zero, the Electrostatic Discharge Output is switched from low (0) to high (1).</p> <p>0: Electrostatic voltage not discharged</p> <p>1: Electrostatic voltage discharge time has elapsed.</p>
16	Analog Output External Power	<p><b>Analog Output External Power (24VDC)</b></p> <p>Apply power (24 VDC / 100 mA) to this pin to power the analog output circuitry. This voltage is to be supplied externally, i.e., from PLC. Can be omitted if the analog outputs are not required.</p>
17	Ground	<p><b>I/O Ground</b></p> <p>Reference potential for discrete I/O interface signals.</p>

Pin	Type	Description
18	Digital Input	<p><b>SAFE POSITION Interlock Input</b></p> <p>The controller will not activate the electrostatics unless this and all other interlock inputs have been satisfied. If satisfied in another manner, this interlock can be disabled by changing switch 2 to the ON position on the controller main circuit board. See <a href="#">Disable Controller Interlocks, page 8</a> .</p> <p>The SAFE POSITION interlock does not deactivate electrostatics when the signal is not satisfied. This signal indicates that a robot or applicator is in a position in which it is safe to activate electrostatics without arc detection.</p> <p>0: Interlock not satisfied: If electrostatics are off, electrostatics disabled. If electrostatics are on, no change to electrostatics.</p> <p>1: Interlock satisfied; electrostatics activation is not locked by this input.</p> <p><b>NOTE:</b> Switching from 1 to 0 does not deactivate electrostatics.</p> <p>Symbol A10 on the display screen (see <a href="#">Screen Areas, page 35</a>) will show that this signal is satisfied.</p>
19	Digital Input	<p><b>24VDC Interlock Input</b></p> <p>The controller will not activate electrostatics unless this and all other interlock inputs have been satisfied. If satisfied in another manner, this interlock can be disabled by changing switch 1 to the ON position on the controller main circuit board. See <a href="#">Disable Controller Interlocks, page 8</a> .</p> <p>0: Interlock not satisfied; electrostatics disabled</p> <p>1: Interlock satisfied; electrostatics activation is not locked by this input.</p> <p>Symbol A9 on the display screen (see <a href="#">Screen Areas, page 35</a>) will show that this signal is satisfied.</p>

## Analog Inputs

The analog inputs are used to set certain parameters remotely by a PLC. The inputs can be configured to be either voltage or current inputs. This setting applies to all inputs simultaneously.

### Electrical Specifications

Use Parameter P03 (See [Setup Screen 3 \(Analog Input Type Select\)](#), page 42) to select the input signal type.

Voltage input mode, P03 = 0

Parameter	Value
Nominal input range	0 – 10 VDC
Input impedance	4.7 k $\Omega$
Maximum allowed input voltage	30 VDC
Reverse polarity protection	Yes
Accuracy	1% typical
Recommended source impedance	< 10 $\Omega$

Current input mode, P03 = 1

Parameter	Value
Nominal input range	4 – 20 mA (sinking)
Input impedance	100 $\Omega$
Maximum allowed input voltage	30 V
Reverse polarity protection	Yes
Input current limit	Yes, 25 mA
Accuracy	1% typical

## Analog Outputs

The analog outputs are used to communicate actual values to other devices, such as a PLC. The outputs can be configured to be either voltage or current outputs. This setting applies to all outputs simultaneously. The analog outputs require an external 24VDC voltage to be connected to Analog Output External Power (discrete I/O interface, pin 16).

### Electrical Specifications

Use Parameter P04 (See [Setup Screen 4 \(Analog Output Type Select\)](#), page 42) to select the output signal type.

Voltage output mode, P04 = 0

Parameter	Value
Output voltage range	0 – 10 VDC
Output impedance	< 10 $\Omega$ (sourcing)
Short circuit protection	0 – 30 VDC
Accuracy	1% typical

Current output mode, P04 = 1

Parameter	Value
Output current range	4 – 20 mA
Output impedance	< 10 $\Omega$ (sourcing)
Short circuit protection	0 – 30 V
Accuracy	1% typical
Maximum load resistance	1 k $\Omega$ (0–20 VDC)
Minimum load resistance	0 $\Omega$ (0–20 VDC)

## Digital Inputs

### Electrical Specification

Parameter	Value
Input type	Current sinking
Input impedance	>10 kΩ
Maximum allowed input voltage	30 VDC
Minimum required "1" input voltage	> 10 VDC
Maximum allowed "0" input voltage	< 4 V (Open inputs have "0" level)

## Digital Outputs

The digital outputs provide status signals to other devices, such as a PLC.

**NOTE:** Digital outputs require a pullup to the connecting device's logic level "1" (e.g., 24VDC).

### Electrical Specification

Parameter	Value
Output type	NPN Open Collector, sinking
Output impedance	1.8 kΩ
Maximum allowed output voltage	30VDC
Short circuit protection	0 – 30VDC

## Discrete I/O Interface Connections

The electrical connections for the Discrete I/O interface pins are shown here.

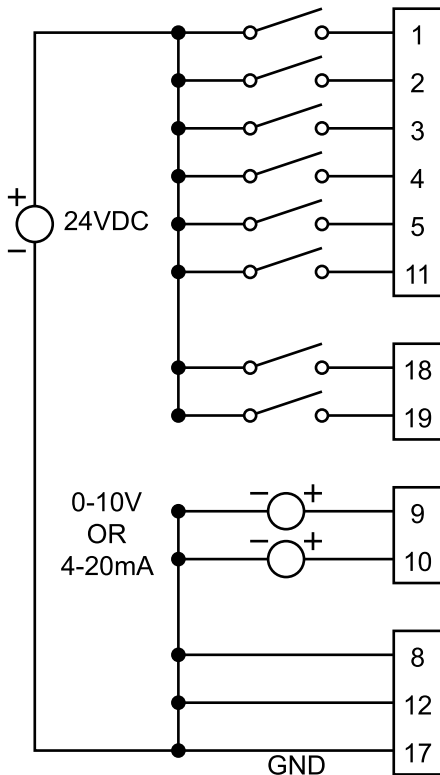

Digital and Analog Inputs

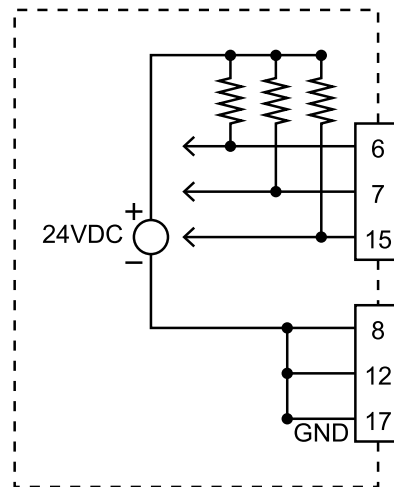

Digital Outputs — Sinking outputs with external pull-up shown

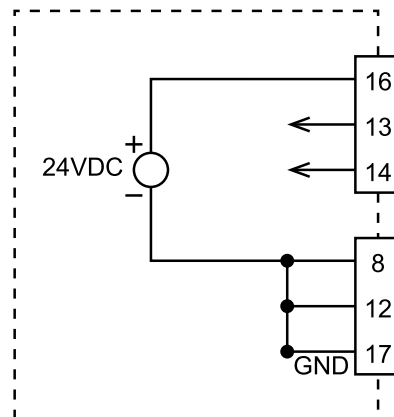

Analog Outputs







# Operation Modes and Timing Diagrams

The system control logic is responsible for turning the electrostatics on and off. The spray system has several modes of operation. These modes describe the system state, but are not selectable by the user. It is important that these are understood for proper integration and safety.

The operation modes are:

- Standby: Electrostatics held in off mode
- SAFE POSITION: Verify the applicator position before enabling the electrostatics
- Spray: Fluid and electrostatics enabled, applicator in motion
- Error handling
- Purge: Flush solvent is present, no electrostatics, applicator not in motion

				
<p>To avoid fire, explosion, and electric shock, always turn the electrostatics off when flushing, cleaning, or servicing equipment. Always ground equipment and waste container.</p> <p>This can be accomplished by using one of the interlock inputs or through control of the Electrostatic Enable pin. This can also be accomplished by powering down the controller.</p>				

## Standby Mode

The standby mode is when the electrostatics are off because the system is not ready to perform a spraying operation. During the standby mode, the following conditions may exist:

- The system is powered down
- Fluid is being loaded

The controller will deactivate the electrostatics (if electrostatics are activated), or will prevent the electrostatics from being activated, when any or a combination of the following signals go low:

- System interlock (power connector)
- 24VDC Interlock
- Electrostatic Enable

**NOTE:** The SAFE POSITION input will not deactivate electrostatics if they are already on. The SAFE POSITION input will only prevent electrostatics from being activated.

All input signals shown here must be high for the controller to enable electrostatics.

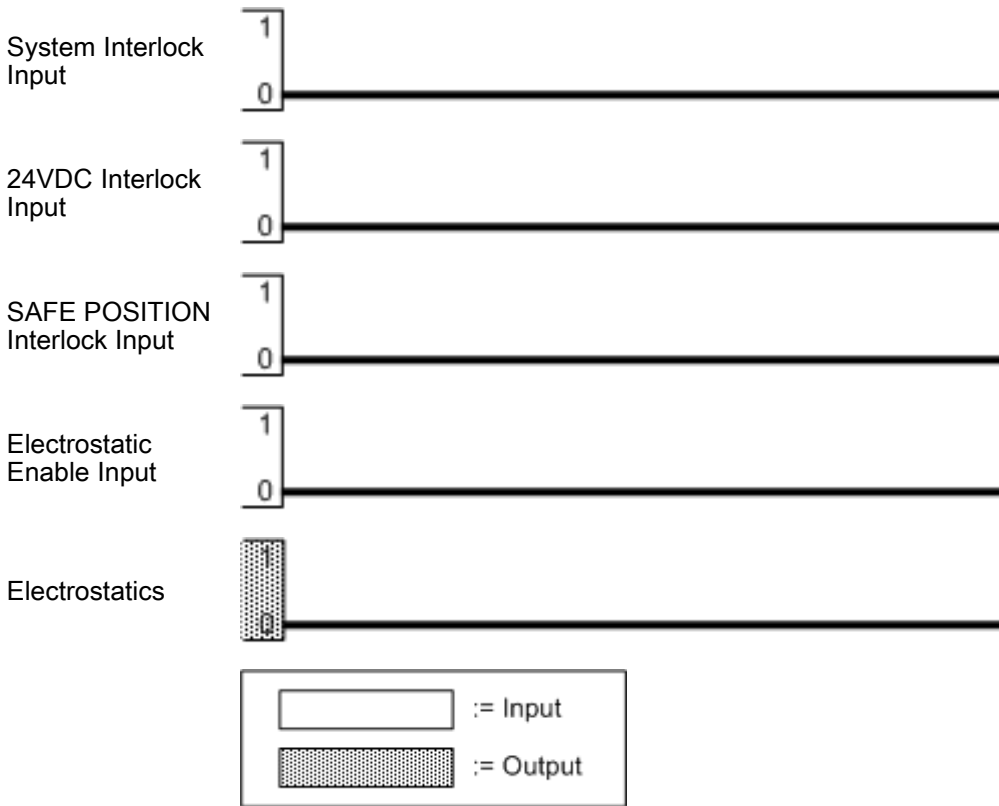

## SAFE POSITION Mode

The SAFE POSITION is defined as a position where the gun electrode is at least 8 inches away from any grounded object. While many such positions may exist, one position should be selected as the applicator SAFE POSITION. When the applicator is in the SAFE POSITION, electrostatics can be activated, blanking time allowed to elapse, and arc detection activated. The applicator should remain in the SAFE POSITION until the system reaches full voltage and arc detection is active.

To enable electrostatics using SAFE POSITION:

1. Satisfy the System and 24VDC interlocks.
2. If controlling the system through the discrete I/O interface, set the REMOTE input high.
3. Move the applicator to SAFE POSITION. Then set the SAFE POSITION interlock high to tell the Pro Xpc Auto controller that the applicator is in SAFE POSITION and that the electrostatics can be activated.
4. Set the Electrostatic Enable input high or activate the electrostatics..
5. The Pro Xpc Auto controller activates the electrostatics at the gun.
6. The Safe-to-Move output is set high when the time defined by the arc detection blanking parameter (C1) value, as defined on [Setup Screen 11 \(Transition Time\), page 45](#) has elapsed after receiving the Electrostatic Enable input high signal. The Safe-to-Move signal indicates that the controller has determined that the gun electrostatics are ready for application and that the applicator can move freely. Arc detection is deactivated during the blanking time. The C1 setting defines the length of time before arc detection is enabled.

When the applicator leaves the SAFE POSITION, the SAFE POSITION Interlock is removed, which leaves it not satisfied. This does not disable the electrostatics. If the electrostatics are deactivated, the robot needs to return to the SAFE POSITION and reapply the SAFE POSITION Interlock input in order to activate the electrostatics.

### SAFE POSITION Timing Diagram

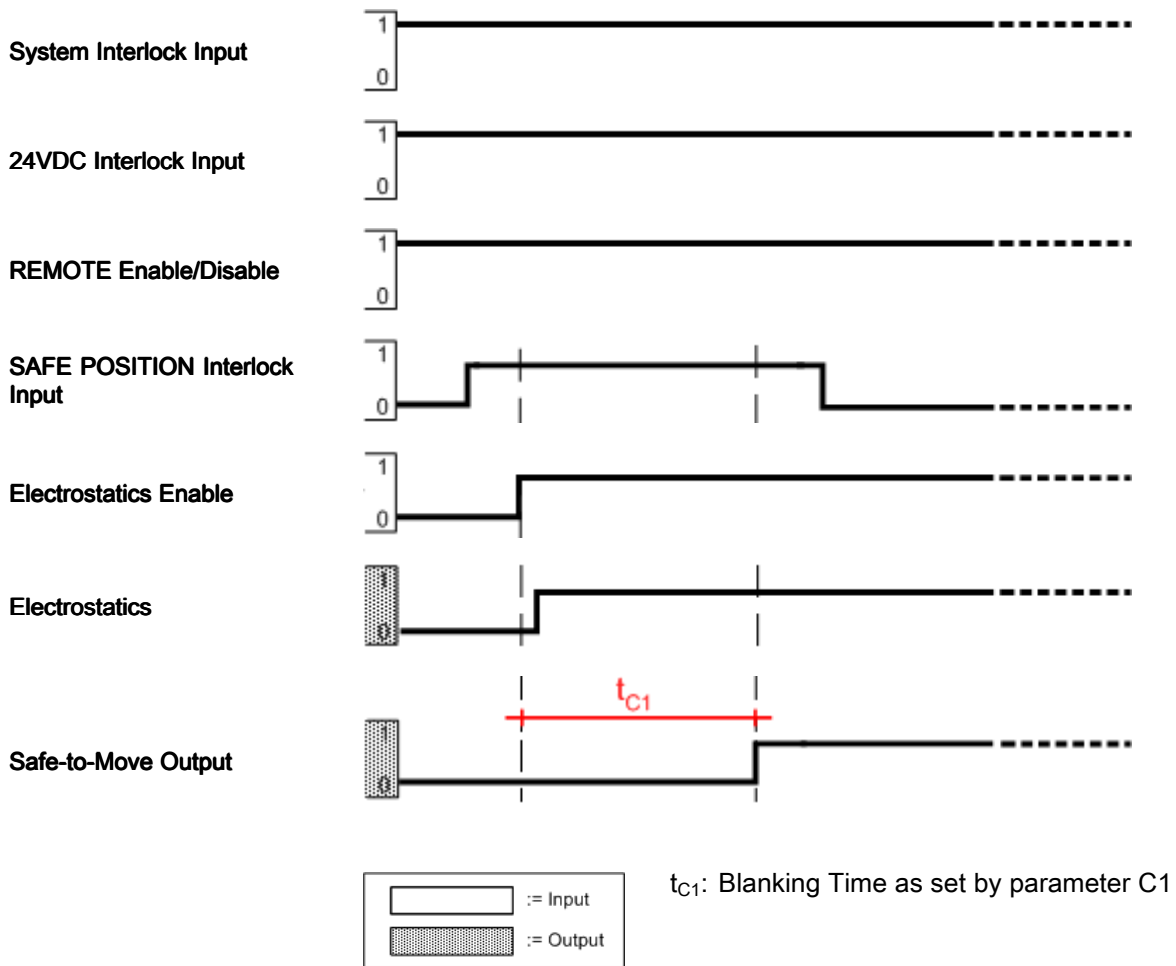

## Spray

The system is in spray mode when the applicator is ready to leave SAFE POSITION or is in motion and electrostatics are enabled.

To start spraying:

1. Satisfy all interlocks (shown as “All Interlocks”)
2. If spraying using the Discrete I/O interface, enable REMOTE operation using the Remote Enable/Disable input.
3. Set the desired voltage and current:
  - a. If spraying in local mode using the Pro Xpc Auto Controller interface, select the active Preset (P000-P003) using the **<P>** keys. Set the voltage and current setpoints using the **<** and **>** keys (see [Run Screen 1 \(Electrostatics Readings\)](#), page 47).
  - b. If using the discrete I/O interface, select the active Preset (P000-P003) using Preset Select 1 and Preset Select 2. If analog control is desired, select Preset P000. Use the Current Setpoint Input and Voltage Setpoint input to adjust the electrostatics.
  - c. If using the CAN interface, select the active Preset or select the desired voltage and current.
4. Activate the electrostatics. If spraying in local mode using the Pro Xpc Controller interface, activate the electrostatics using the **⏻** key. If using the discrete I/O interface, activate the electrostatics using the Electrostatic Enable Input.
5. If spraying in REMOTE mode, monitor the Safe-to-Move Output to know when the blanking time has passed and arc detection is enabled. The blanking time is defined by Parameter C1 (see [Setup Screen 9 \(Blanking Time\)](#), page 44).
6. Change the desired electrostatic output:
  - a. If spraying in local mode using the Pro Xpc Auto Controller interface, change the active Preset (P000-P003) using the **<P>** keys. Set the voltage and current setpoints using the **<** and **>** keys (see [Run Screen 1 \(Electrostatics Readings\)](#), page 47).
  - b. If using the discrete I/O interface, change the active Preset (P000-P003) using Preset Select 1 and Preset Select 2. If analog control is desired, select Preset P000. Use the Current Setpoint Input and Voltage Setpoint input to adjust the electrostatics.
  - c. If using the CAN interface, change the active preset or change the desired voltage and current.

The electrostatics will transition to the desired output over the transition time. This time is set by Parameter C3 (see [Setup Screen 11 \(Transition Time\)](#), page 45). The transition time is not used during activation (0 to setpoint) or deactivation (setpoint to 0).
7. Disable the electrostatics when done spraying. If spraying in local mode using the Pro Xpc Controller interface, deactivate the electrostatics using the **⏻** key. If using the discrete I/O interface, deactivate the electrostatics using the Electrostatics Enable Input.
8. If spraying in REMOTE mode, monitor the Electrostatic Discharge Output to know when the discharge time has passed and the system is fully discharged. The discharge time is defined by Parameter C2 (see [Setup Screen 10 \(Discharge Time\)](#), page 45).

The diagram below shows discrete I/O REMOTE mode and shows three parts of electrostatic spraying: activate, setpoint change, and deactivate. Blanking time  $t_{C1}$ , transition time  $t_{C2}$ , and discharge time  $t_{C3}$  are also illustrated.

### Spray Timing Diagram

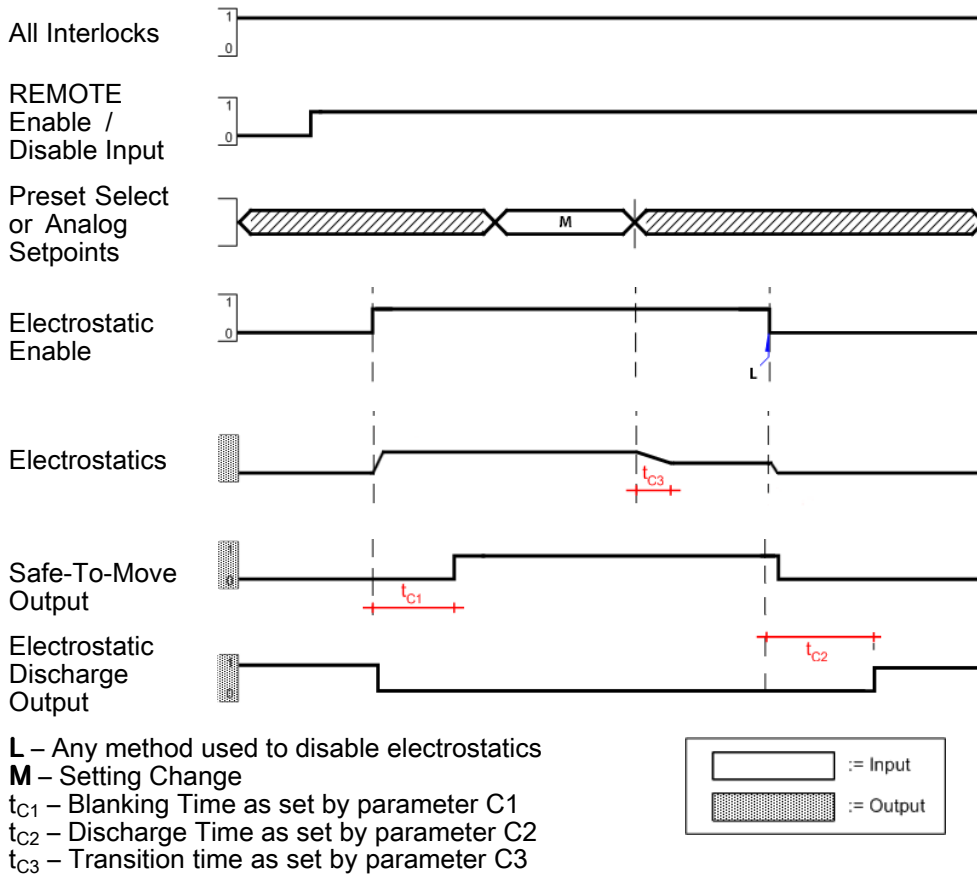

## Error Handling

The system is in error handling mode when an error occurs that disables electrostatics. When an error occurs, an error code is generated. This error code is shown in red on the Pro Xpc Auto Controller user interface in location A5 and Discrete I/O Error Output signal is high.

Handle an error with the following procedure:

1. Fix the condition that caused the error code (see [Troubleshooting, page 56](#)).
2. Acknowledge the error code:
  - a. If using the discrete I/O interface, acknowledge the error code using Discrete I/O Error Reset, (Pin 3).
  - b. If in local mode, acknowledge the error code using the **<P>** button (T11) on the Pro Xpc Auto controller user interface.

3. Move the robot to SAFE POSITION. Satisfy the SAFE POSITION interlock.
4. Activate the electrostatics.
5. The Blanking Time passes; Safe-to-Move output is set high.

The diagram shows an example of error handling using the discrete I/O interface.

## Error Handling Timing Diagram

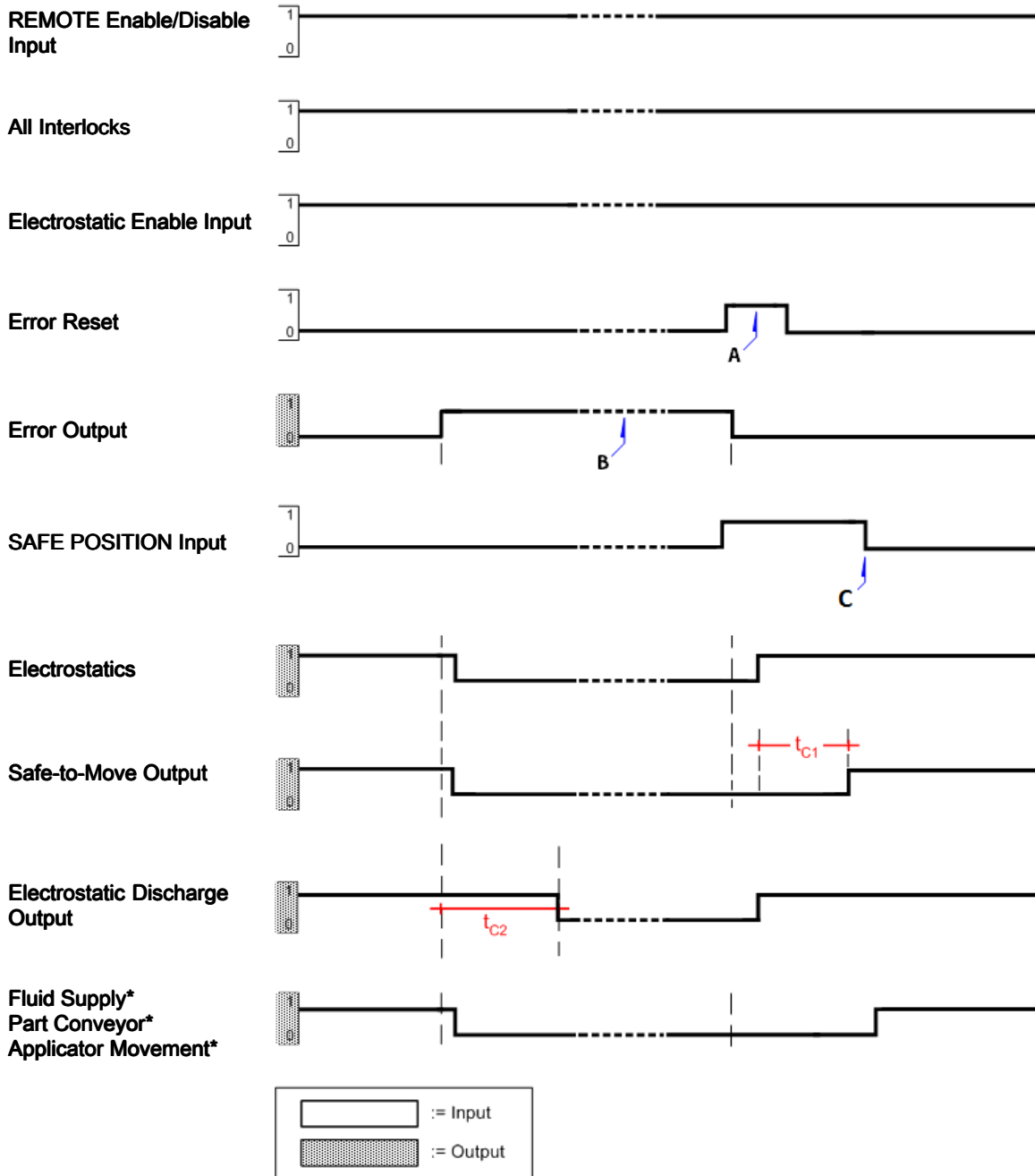

A: Hold high until error output is low

B: Fix error condition

C: Robot has begun movement from SAFE POSITION after Safe-to-Move

$t_{c1}$ : Blanking Time as set by parameter  $t_{c1}$

$t_{c2}$ : Discharge Time as set by parameter  $t_{c2}$

\* Not controlled by electrostatic controller



## Purge

During Purge mode flush solvent is present, electrostatics are disabled, and the applicator is not in motion.

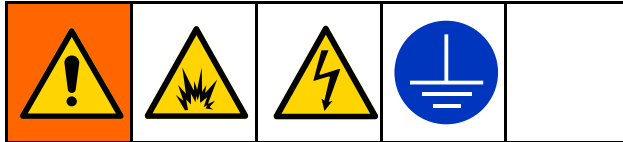

To avoid fire, explosion, and electric shock, always turn the electrostatics off when flushing, cleaning, or servicing equipment. Always ground equipment and waste container.

This can be accomplished by using one of the interlock inputs or through control of the Electrostatic Enable pin. This can also be accomplished by powering down the controller.

Disable the electrostatics any time the solvent supply is activated. Before enabling electrostatics again, ensure that the fluid lines are completely free of solvent. Determine any time and volume requirements for paint to be loaded. Ensure that the electrostatics are disabled for the entire load sequence.

Deactivate the electrostatics using one or combination of the following signals:

- System Power Interlock: Low
- 24VDC Interlock: Low
- Electrostatic Enable Input: Low
- Powering off the Pro Xpc Auto Controller by pressing the **off** button.

## Purge Timing Diagram

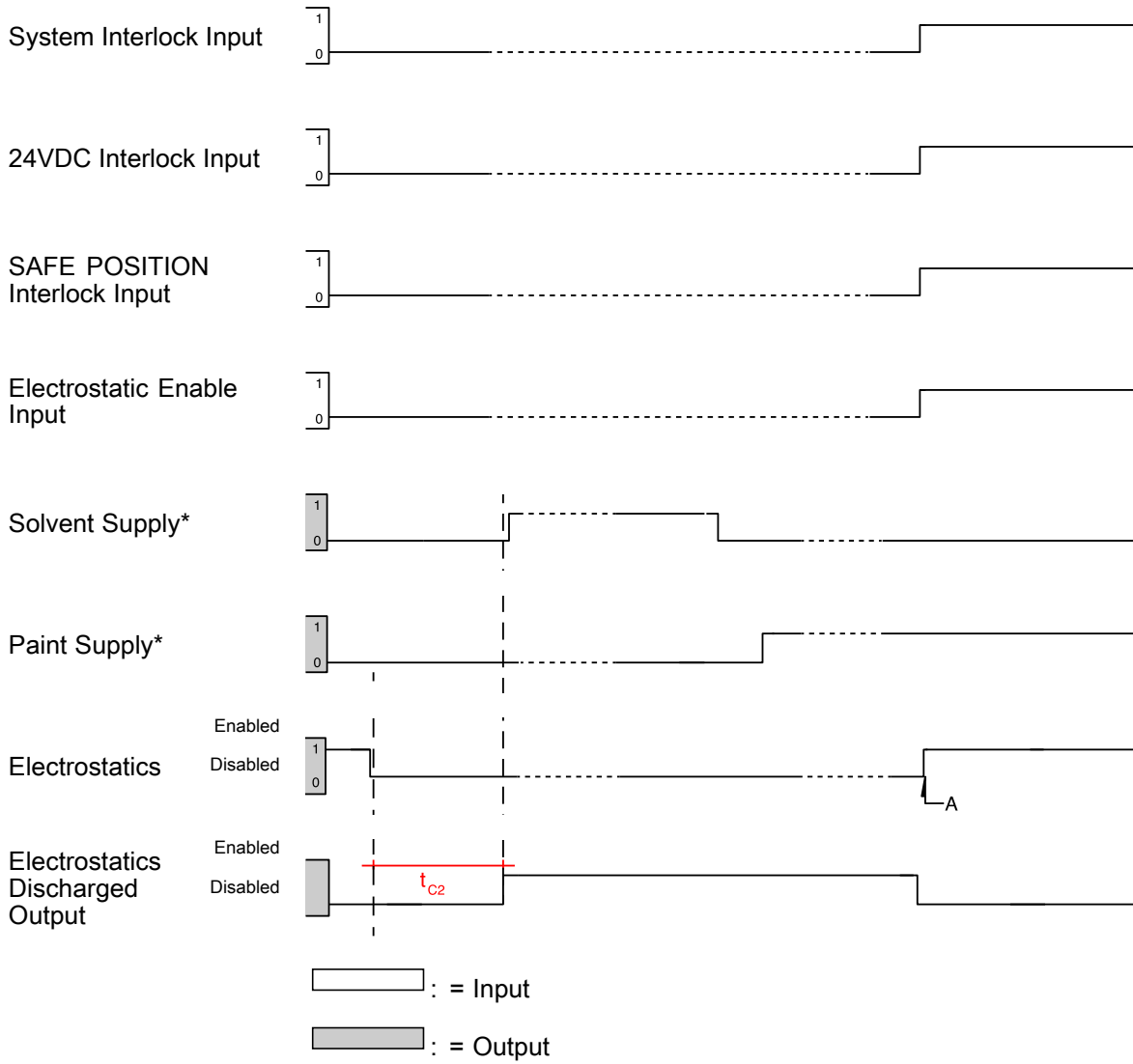

\* Not controlled by electrostatic controller

A: Fluid lines free of solvent, OK to activate electrostatics

# Controller Display and Features

## Screen Areas

There are five areas on the screen used for numerical information. Six additional areas provide non-numerical information.

Designation	Function
-------------	----------

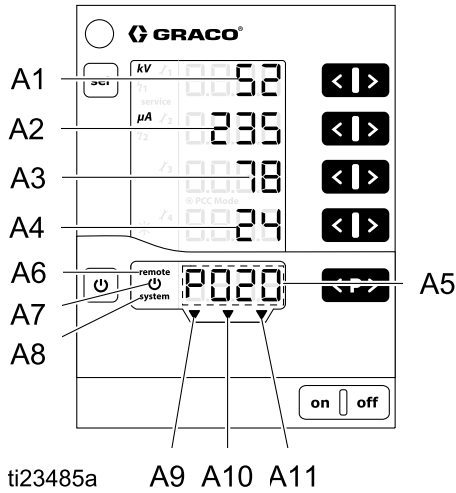

A1–A4	Displays actual values, preset values, and system parameters. Flashes when the possible range is exceeded.
A5	Displays Preset number, error diagnosis codes, and status information.
A6	REMOTE operation enabled
A7	Electrostatics active/triggered
A8	System interlock connection satisfied
A9	SAFE POSITION Interlock satisfied
A10	24VDC Interlock satisfied
A11	Electrostatic Enable input is Active

## Icons

Icon	Explanation
<b>kV</b>	Electrostatic voltage (displayed in kV)
<b>μA</b>	Electrostatic current (displayed in μA)
	Electrostatics activate/trigger
<b>remote</b>	REMOTE operation active. Blinks when the keyboard lock is active
<b>system</b>	System interlock satisfied
	Display backlight illumination (0–8)
	Maintenance reminders
	Static arc setting
	Dynamic arc setting
<b>service</b>	One of the four maintenance counters has reached 0.

## Input Keys and Switches

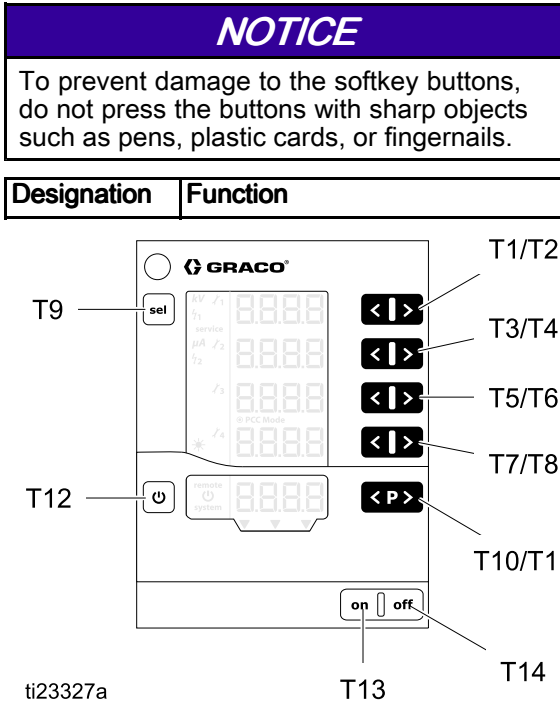

T1-T8	Input keys for preset values and system parameters or configurations. Used to increase or decrease values shown.
T9	Switch between system parameters (P00–P07) and system configurations (C0–C3)
T10-T11	Preset change.
T12	Electrostatics activate/trigger. Switch between Run and Setup screens.
T13	Controller power on.
T14	Controller power off.



## Additional Features

### Keyboard Lock

The keyboard lock can be used to prevent changes to individual voltage and current parameter values within the Presets while the controller is operating locally. When the keyboard lock is active, the controller continues to allow:

- Preset selection
- Display of preset values of the current Preset
- Display of the actual values
- Error acknowledgement

#### Activate/deactivate the keyboard lock

1. Press the  key and the  (T8) key at the same time.
2. The **remote** display blinks when the keyboard lock is activated.
3. The keyboard lock is cancelled by pressing the same key combination again.

The keyboard lock status remains stored, when switching the controller off and on. The keyboard lock is cancelled if factory defaults are restored.

**NOTE:** The keyboard lock is independent from the screen lock. The screen lock feature is present in REMOTE operation.



### Screen Lock

When in REMOTE mode, the available keypad functions and available screens are limited because a screen lock is active. During screen lock, the available functions are limited to:

- Display of active preset values
- Display of the actual values
- Error acknowledgement

**NOTE:** If the keyboard was locked when remote mode is entered, the **remote** display will continue to blink.

### Checking the Software Version

1. Press the  key and the  at the same time.

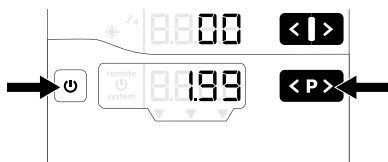

2. The software version is displayed as long as the keys are held.

### Restore Factory Defaults

All parameters (**except P00**) and configurations (C0 – C3), as well as all user-defined values, will be overwritten with factory default. Any active keyboard lock or screen lock will be removed.

Maintenance counts, state (active/non-active) and setpoints are NOT reset.

**NOTE:** By restoring factory defaults, except for display backlight setting, all user-made settings will be set to factory default.

1. Press **off** on the controller.
2. Press and hold .
3. Press **on** on the controller. The **CLr** display blinks.



4. Wait for approximately 5 seconds, until **CLr** disappears.
5. Release the  key.
6. All values are reset.

### Auto Power Save Mode

The display backlight turns off automatically after five minutes of electrostatics inactivity. Touching any key will turn the display backlight back on.

# Setup

The Pro Xpc Auto Controller has setup screens that define how the controller functions. This setup is saved in the equipment memory, even when power is removed. The controller is set up by using the system parameters and configuration screens. These values can be adjusted in the setup screens.

1. Press **on** to turn on the controller.
2. To access the Setup Screens, press and hold **U** for 5 seconds from any Run Screen. Press buttons T1/T2 to move between Setup Screens 0-7 (Parameters).

**NOTE:** Press  to access Setup Screens 8-11 (Configuration). Press buttons T1/T2 to move between Screens 8-11. To return to Setup

Screen 1, press  again.

3. To return to the Run Screens, press **U** from any Setup Screen.

This table summarizes the system parameters (P00-P07) that are defined using Setup Screens 0-7. The table also shows the configurations (C0-C3) that are defined using Setup Screens 8-11. Each Setup Screen is then described in detail in the sections that follow the table.

PARAMETERS				
Setup Screen	Display (A1) Value	Description	Display (A3) Values	Display (A4) Value
0	P00	<i>Applicator Type</i> Display A2: APP  Use to define applicator type and features. This selection is set in the factory and cannot be changed. This selection is not overwritten if a Factory Default Reset is performed.	0: Standard (solventborne) 1: Waterborne	Std UUb
1	P01	<i>Electrostatic Control Mode</i> Display A2: Ctrl  Define how electrostatics generation is controlled. This selection is set to 1 (current) in the factory and cannot be changed.	1: Current Control	CUrr
2	P02	<i>Remote Interface</i> Display A2: bUS  Use to select the remote interface from which the controller will accept external control.	0: Off 1: Discrete I/O (default) 2: CAN	oFF dio CAN
3	P03	<i>Analog Input Type</i> Display A2: Ai  Use to select the input signal type for the discrete I/O analog inputs.	0: Voltage(default) 1: Current	Volt CUrr
4	P04	<i>Analog Output Type</i> Display A2: Ao  Use to select the output signal type for the discrete I/O analog output.	0: Voltage (default) 1: Current	Volt CUrr

PARAMETERS				
Setup Screen	Display (A1) Value	Description	Display (A3) Values	Display (A4) Value
6	P06	<i>CAN Purpose ID</i> Use to set the purpose ID for CAN communication.	0–32 0 (default)	Pid
7	P07	<i>Log level</i> Display A2: LoG Use to designate how much information is logged in the system.	0–4 0 (default)	LoG

CONFIGURATION			
Setup Screen	Display (A1) Value	Description	Display (A2) Values
8	C0	<i>Arc detection averaging interval <math>\Delta t</math> [sec]</i> Use to set the time interval that the controller will use to calculate the dynamic arc.	0.01–0.5 by 0.01 0.10 (default)
9	C1	<i>Arc detection blanking time setpoint [sec]</i> Use to set the amount of time after turning on the high voltage during which arc detection is suppressed.	0.0–30.0 by 0.1 0.5 (default)
10	C2	<i>Discharge timer setpoint [sec]</i> Use to set the time needed to fully discharge after turning off the electrostatics.	0.0–60.0 by 0.1 0.0 (soventborne default) 30.0 (waterborne default)
11	C3	<i>Transition Time Interval [sec]</i> Use to set the interval of transition time between electrostatic setpoints.	0.0 – 5.0 by 0.1 0.0 (default)

## Setup Screen 0 (System Type)

Setup Screen 0 (Parameter P00) displays the type of electrostatic applicator (APP) in use. The Pro Xpc Auto Controller is factory set to 0 (Std) and cannot be changed.

**NOTE:** This parameter is not overwritten if a Factory Default Reset is performed.

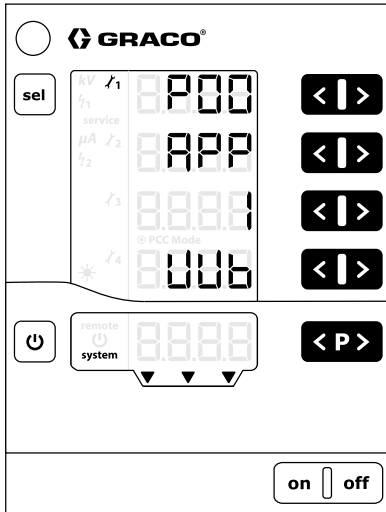
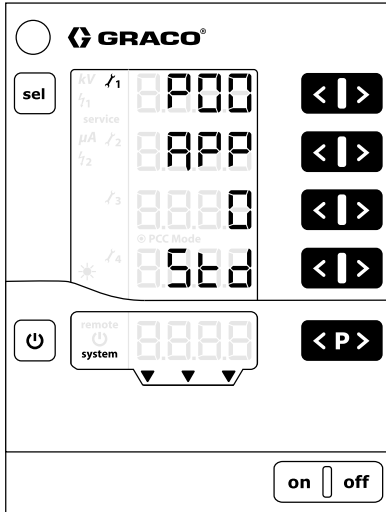

Std: Solventborne product: 100 kV maximum

UUb: Waterborne product: 60 kV maximum

## Setup Screen 1 (Electrostatics Control Mode)

Setup Screen 1 (Parameter P01) displays the electrostatics control mode (Ctrl) in use. The Pro Xpc Auto Controller is factory set to Current (1, CUrr) and cannot be changed.

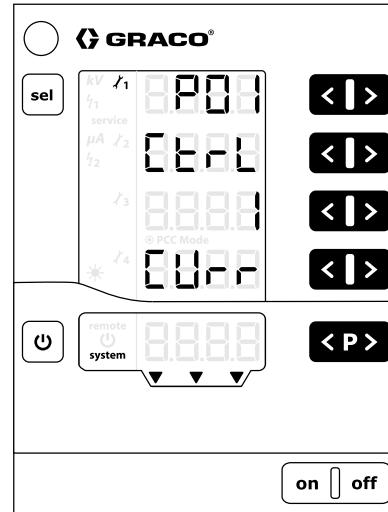



## Setup Screen 2 (Remote Interface)

Use Setup Screen 2 (Parameter P02) to select the remote interface (bUS) from which the controller will accept external control. Press buttons T5/T6 to change the setting.

The options are:

- **0 = oFF**: Discrete I/O interface is disabled (local operation).
- **1 = dio**: Discrete I/O interface is enabled. This selection is the default. See [Discrete I/O, page 18](#), for more information.
- **2 = CAn**: CAN interface is enabled. The CAN interface is used to communicate with Graco modules. When CAN interface is enabled, the following Discrete I/O functions are disabled:

- Current Setpoint Input (Pin 9)
- Voltage Setpoint Input (Pin 10)
- Preset Select 1 and 2 (Pins 1 and 2)

[See [Discrete I/O, page 18](#).]

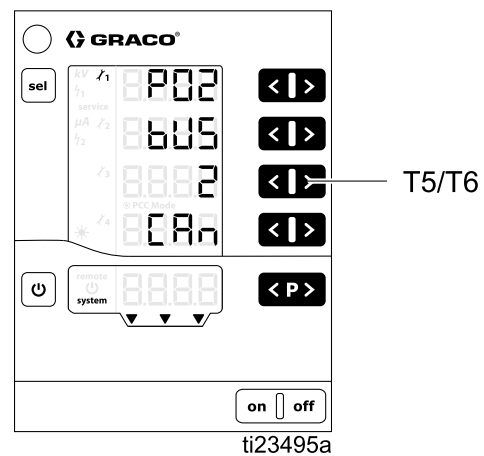
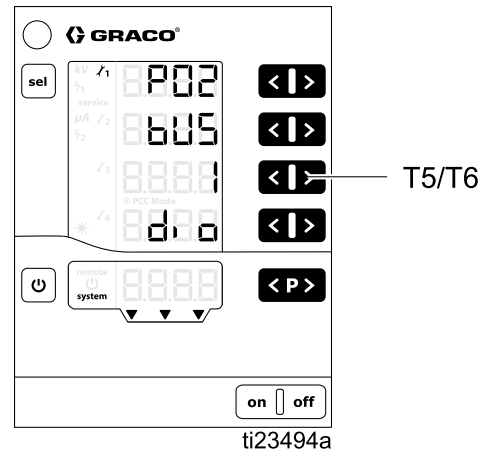
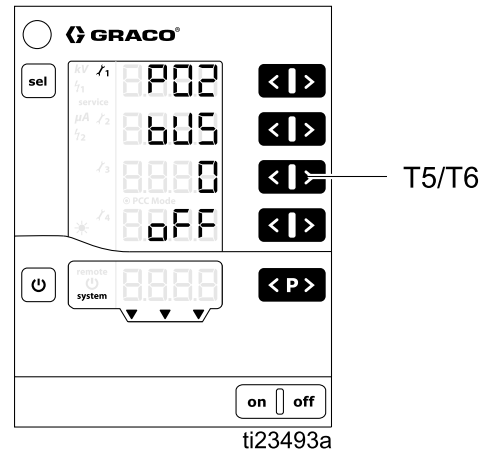

### Setup Screen 3 (Analog Input Type Select)

Use Setup Screen 3 (Parameter P03) to select the input signal type for the discrete I/O interface analog inputs (Ai). Press buttons T5/T6 to change the setting. The options are:

- **0 = VoLt:** Analog voltage inputs are voltage type (0 - 10 V). This selection is the default.
- **1 = CUrr:** Analog current inputs are current type (4 - 20 mA).

This setting applies to Current Setpoint and Voltage Setpoint analog inputs for the Discrete I/O interface. See [Discrete I/O, page 18](#), for more information.

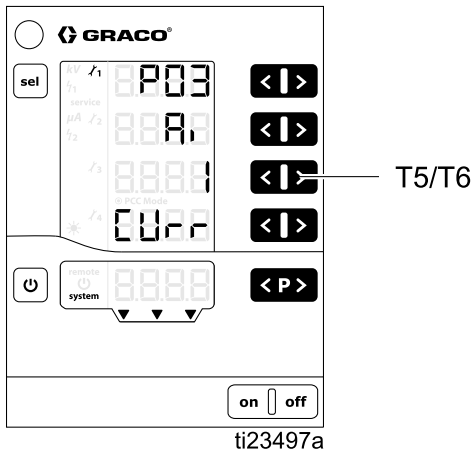
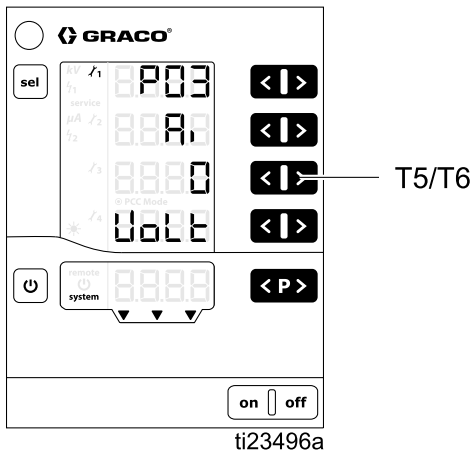

### Setup Screen 4 (Analog Output Type Select)

Use Setup Screen 4 (Parameter P04) to select the output signal type for the discrete I/O interface analog outputs (Ao). Press buttons T5/T6 to change the setting. The options are:

- **0 = VoLt:** Analog outputs are voltage type (0-10V). This selection is the default.
- **1 = CUrr:** Analog outputs are current type (4-20mA).

This setting applies to Actual Spraying Current and Actual Spraying Voltage analog outputs for the discrete I/O interface. See [Discrete I/O, page 18](#), for more information.

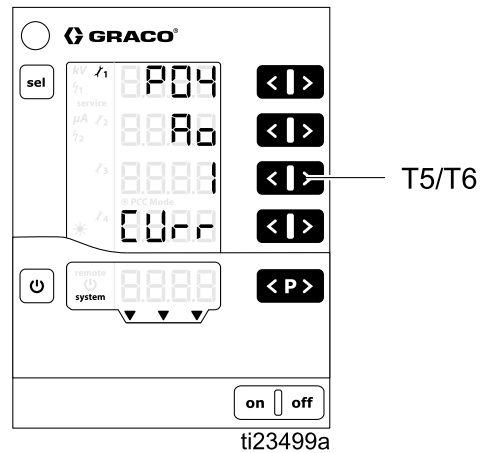
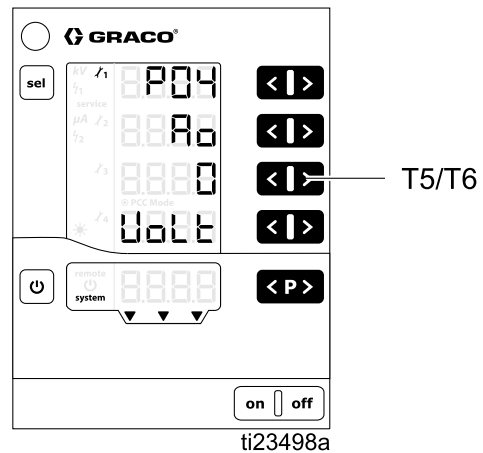

## Setup Screen 6 (CAN Purpose ID)

Use Setup Screen 6 (Parameter P06) to select the CAN purpose ID of the controller. For one gun systems, set the value to 0 (default). For a multi-gun system, set the CAN purpose IDs to match each gun number. For example:

- 0 = gun 1
- 1 = gun 2

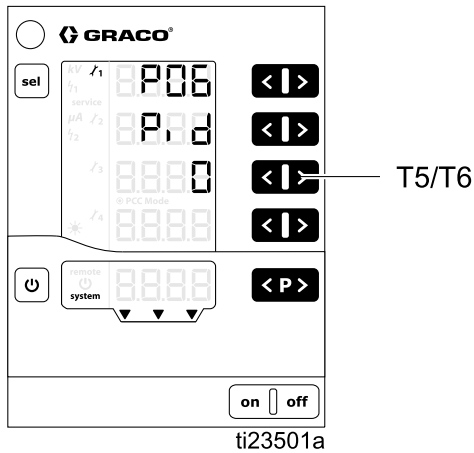

## Setup Screen 7 (Log Level)

Use Setup Screen 7 (Parameter P07) to select the log level (LoG) for how much information is logged in the system (used for troubleshooting only). Press buttons T5/T6 to change the setting. A setting of 0 means nothing is logged. A setting of 4 means everything is logged. The default is zero (0).

**NOTE:** For logging, a micro SD card must be inserted in the slot found on the main circuit board. If a software update has been done by installing a micro SD card, this card can be used for logging. If no card has been installed, or to verify whether one is present, see [Software Update, page 66](#).

The controller can export log reports of controller activity to an installed micro SD card for test purposes and for finding defects.

**NOTE:** If a micro SD card is present when the controller is turned on, the log messages are recorded in a file (MESSAGES.LOG) located in the root directory. When the file size reaches 32 MB, it is renamed MESSAGES.1 and a new MESSAGES.LOG file is created. Subsequent log file names will be sequentially numbered.

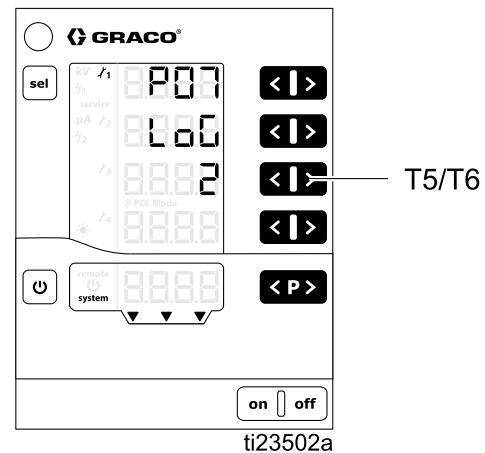

## Setup Screen 8 (Averaging Interval)

Use Setup Screen 8 (Configuration C0) to select the averaging interval (in seconds) used to calculate the dynamic arc. Press buttons T3/T4 to change the setting. The default is sufficient for most applications.

See [Arc Detection, page 50](#) for more information.

- Range is 0.01 – 0.5 by 0.01
- Default 0.10 (shown)

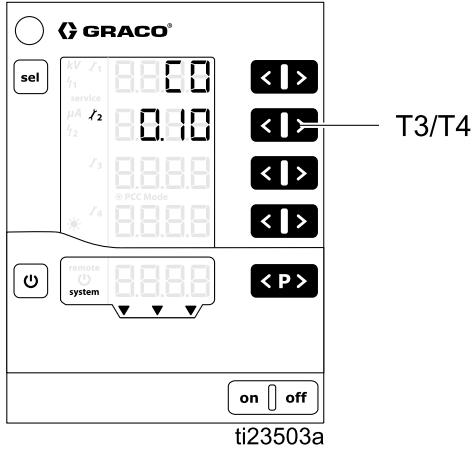

## Setup Screen 9 (Blanking Time)

The Pro Xpc Auto Controller uses a fixed blanking time which is defined by this screen. The blanking time is the time between when electrostatics are activated and Arc Detection is enabled. Adjust the Blanking time duration to ensure that the system reaches full voltage during the Blanking time. If arc detection errors occur when the electrostatics are activated, increase the Blanking time or adjust the arc detection parameters to be less sensitive, as defined in [Run Screen 2 \(Arc Limits\), page 48](#) and [Arc Detection, page 50](#).

Use Setup Screen 9 (Configuration C1) to select the time (in seconds) for which arc detection is disabled (blanking time) after electrostatics are activated. This setting controls the time from when the electrostatics are enabled until arc detection is enabled. Press buttons T3/T4 to change the setting.

See [Arc Detection, page 50](#) for more information.

- Range is 0.0 – 30.0 by 0.1
- Default is 0.5 (shown)

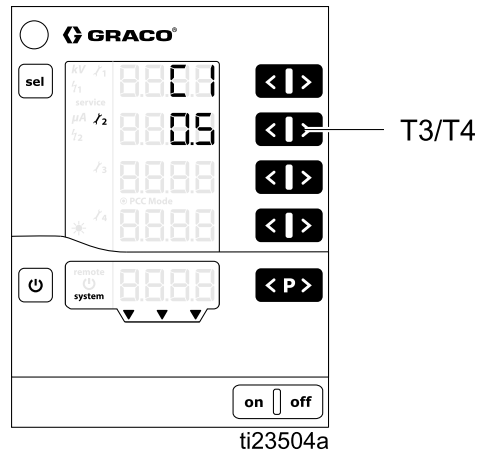

## Setup Screen 10 (Discharge Time)

Use Setup Screen 10 (Configuration C2) to select the time (in seconds) from when the electrostatics are disabled until the electrostatic voltage is discharged. Press buttons T3/T4 to change the setting. For most solventborne systems, this setting can remain at 0.0, as no discharge time is needed for a solventborne system.

In a waterborne system, set the discharge timer to a value that will ensure that the system has been discharged. Verify that the system is discharged using the Fluid Voltage Discharge and Grounding Procedure in gun manual 332992.

- Range is 0.0 – 60.0 by 0.1
- Solventborne default is 0.0 (shown)
- Waterborne default is 30.0 (not shown)

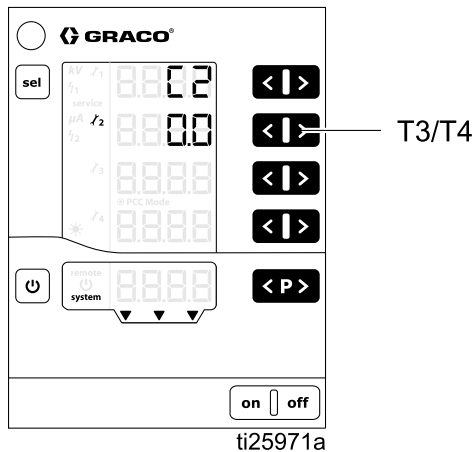

## Setup Screen 11 (Transition Time)

The transition time is the time over which the controller changes the electrostatics. The transition time applies when electrostatics are enabled or when the Voltage Setpoint is changed. Arc detection remains active when the voltage setpoint is changed. If arc detection errors occur when the voltage (or current) setpoint is changed, increase the transition time or adjust the Arc Detection parameters to be less sensitive (see [Arc Detection](#), page 50).

Use Setup Screen 11 (Configuration C3) to set the interval of transition time (in seconds) for the electrostatic output. This setting will help eliminate nuisance arc detection errors during transition time. Press T3/T4 to change the setting.

- Range is 0.0 – 5.0 sec
- Default is 0.0 (shown)

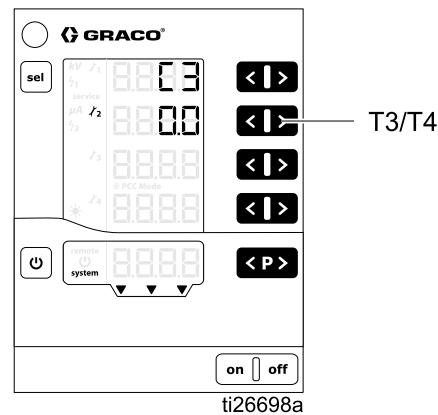

# Operation

## System Startup

Press **on** to turn on the controller. The controller always starts up to the last configured settings. The controller has two sets of screens, Run and Setup. This section includes information on the Run screens, used to operate the electrostatic gun. See [Setup Screens, page 38](#), If you have not yet completed initial setup.

Press and hold  to toggle between the Run screens and the Setup screens.

**NOTE:** When viewing Run Screens, after 5 seconds have elapsed since the last keystroke, the display will revert to Run Screen 1.

## Presets



The Pro Xpc Auto Controller has 251 (P000-P250) user-defined Presets. There are four values associated with each Preset. These are:

- Voltage setpoint
- Current setpoint
- Static arc limit
- Dynamic arc limit





Voltage and current setpoints are specified on [Run Screen 1 \(Electrostatics Readings\), page 47](#). Arc limits are specified on [Run Screen 2 \(Arc Limits\), page 48](#).

**NOTE:** Only Presets P000-P003 are accessible through the discrete I/O interface. The CAN interface runs in preset P000 only. All Presets (P000-P250) are accessible in local mode.

## Run Screen 1 (Electrostatics Readings)

				
<p>To reduce the risk of electric shock, do not use the Pro Xpc Auto Controller readings to determine if your system is discharged. The controller will only display the voltage while the gun's power supply is operating. Follow the Fluid Voltage Discharge and Grounding Procedure described in your gun manual.</p>				

Run Screen 1 is the main screen for an electrostatic gun. This screen shows the active preset (A5) and setpoints for voltage (A1) and current (A2). The screen also displays actual values for kV and  $\mu\text{A}$  when the electrostatics are active/triggered. Actual values are displayed in green.

Use this screen to set the voltage (A1) and current (A2) setpoints for each Preset. The setpoint is displayed in black. Setpoints can be changed by pressing the corresponding  and  keys when actual values are displayed. The setpoints also can be viewed by pressing  or  once.

**NOTE:** When in REMOTE operation, these values cannot be changed using the display keys.

**NOTE:** If either the voltage setpoint (A1) or the current setpoint (A2) are set to zero, the electrostatics will not turn on even if electrostatics are enabled.

Press  to select the Preset (P000 — P250).

Press  to acknowledge error codes.

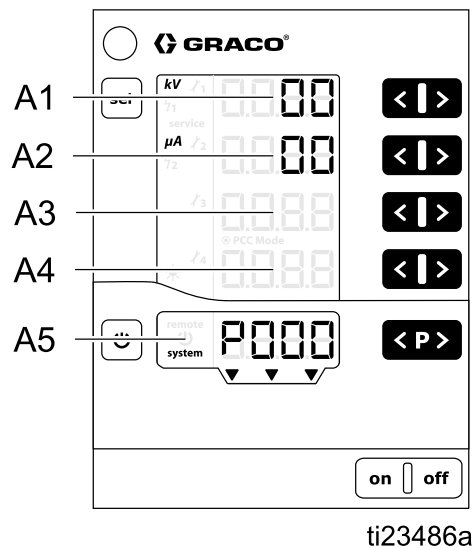

Location	Description	Units	Range	Default
A1	<b>Black:</b> Voltage Setpoint <b>Green:</b> Spraying Voltage	kV	0–100kV (solventborne) 0–60kV (waterborne)	0kV
A2	<b>Black:</b> Current Setpoint <b>Green:</b> Spraying Current	$\mu\text{A}$	0–150 $\mu\text{A}$	0 $\mu\text{A}$
A3–A4	None	—	—	—
A5	Active Preset, error diagnosis, or status	—	—	—

## Run Screen 2 (Arc Limits)

Run Screen 2 is the secondary screen for the electrostatic gun. This screen shows the active Preset, arc detection limits, and screen backlight brightness. Screen backlight brightness is set 0–8, with zero being Off and 8 being the brightest. **NOTE:** The screen will dim automatically after 5 minutes of inactivity. The screen backlight brightness is not reset if factory defaults are restored.

Arc detection is a safety feature of the Pro Xpc Auto Controller. Arc detection is used to detect when grounded objects are too close to the electrostatic spraying device. If this occurs, the controller shuts down electrostatic generation instead of creating an electrical discharge.

The static arc limit is used to detect a grounded object that is stationary or slow moving. The dynamic arc limit is used to detect grounded object that is fast moving. For both static and dynamic arc limits, lower values are more sensitive than higher values.

See [Arc Detection, page 50](#) for more information.

**NOTE:** It is recommended that arc detection settings not be changed from defaults. Any desired change must be set individually for every Preset.

The setpoints are locked. To change the setpoints, press and hold both of the T1/T2 or both of the T3/T4 arrows simultaneously. The setpoint numbers will turn red. Use arrows T1 and T2 to change the static arc limit. Use arrows T3 and T4 to change the dynamic arc limit. Arc detection parameters relock after 4 seconds or when the screen is exited.

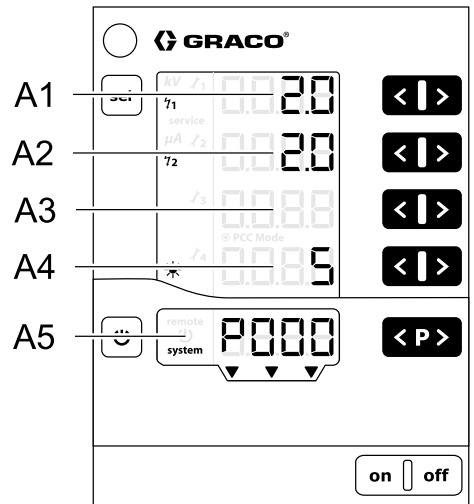

ti23487a

Location	Description	Range	Default
A1	Static Arc Limit	0.1–50 nS	10 nS
A2	Dynamic Arc Limit	0.1–25 nS/s	8.0 nS/s
A3	None	—	—
A4	Screen Backlight Brightness	0–8	5
A5	Active Preset, error diagnosis, or status	—	—







## Run Screen 3 (Maintenance Counters)



Run Screen 3 is the maintenance screen. This screen shows the 4 maintenance counters and the non-resettable trigger counter.

When dashes are shown in the maintenance counters, monitoring is deactivated. When numbers are shown, the maintenance counters show days of remaining service life.

**NOTE:** Maintenance counters are activated only when electrostatics are active/triggered.

**NOTE:** The trigger counter shows an amount of time (in days) that electrostatics have been activated for the connected power supply. It cannot be cleared. Each tenth equates to 2.4 hours of elapsed time.

To activate monitoring: press the corresponding  and  simultaneously for a deactivated counter. During the first activation a value of 1 is shown as the start value. If monitoring has already been activated at some earlier point, then the last stored value is displayed. Set the desired service life for each wearing part using the  and .

To deactivate monitoring: press the corresponding  and  simultaneously for an active counter.

If the selected service life is exceeded, the maintenance counter will be shown as a negative

number. The **service** symbol also will appear. Controller operations are not stopped.

**NOTE:** Maintenance counters, states (active/inactive), and setpoints are not reset when factory defaults are restored.

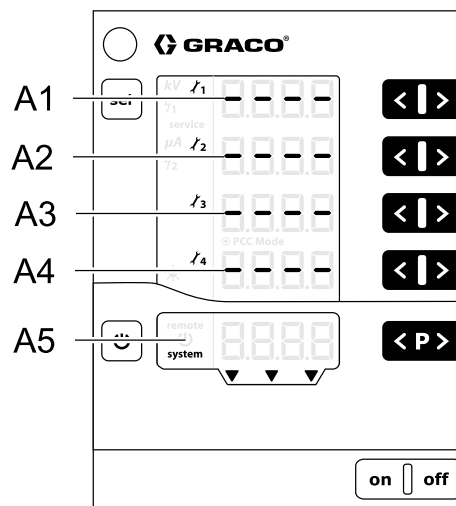

ti23488a

Designation	Function	Units	Range
A1–A4	Maintenance counter 1–4	days	0.1–500
A5	Trigger counter, error diagnosis, or status	days	—

## Arc Detection

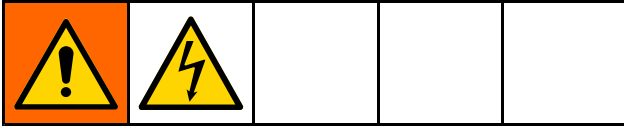



The primary method to prevent arcing is to keep all grounded objects at least 8 in. (20.3 cm) away from the applicator. In addition, the Pro Xpc Auto Controller is equipped with a feature called arc detection. When the conditions suitable to create an arc have been detected, the arc detection circuitry disables the power supply drive circuitry and produces an arc detection error. The power supply drive circuitry remains disabled until the error has been confirmed by the user or the PLC.

### Check Arc Detection Function

Periodically check the function of the arc detection feature. Under safe conditions, with electrostatics activated, approach the gun electrode with a grounded rod and verify that the electrostatics deactivate. Observe the display to verify that an error code of H15, H16, H17, or H18 is displayed.

## Arc Detection Adjustments

The following parameters can be changed to influence the arc detection performance.

Setting	Remarks
<b>Static Arc Limit *</b>  <b>I<sub>1</sub></b> View or change on <a href="#">Run Screen 2 (Arc Limits)</a> , page 48, Location A1	Range: 0.1–50 nS Set the value lower to increase sensitivity and to deactivate the electrostatics sooner as a grounded object approaches the applicator. Set the value higher to decrease sensitivity and to eliminate nuisance errors. This value is most useful for slow-moving targets.
<b>Dynamic Arc Limit *</b>  <b>I<sub>2</sub></b> View or change on <a href="#">Run Screen 2 (Arc Limits)</a> , page 48, Location A2	Range: 0.1–25 nS/s Set the value lower to increase sensitivity and to deactivate the electrostatics sooner if a grounded object is approaching the applicator at too high a speed. Set the value higher to decrease sensitivity and to eliminate nuisance errors.
<b>Voltage Setpoint*</b> View or change on <a href="#">Run Screen 2 (Arc Limits)</a> , page 48, Location A1	Range: 0–100kV (solventborne) or 0–60kV (waterborne) Decrease the voltage if changes to the static and dynamic limits are not sensitive enough.
<b>Averaging Interval</b> View or change on <a href="#">Setup Screen 8 (Averaging Interval)</a> , page 44, Configuration C0	Range: 0.01–0.5 s by 0.01 Valid for all Presets. Set the averaging interval to make the Dynamic Arc Limit more sensitive. Lowering this setting adds to the sensitivity achieved by setting the Dynamic Arc Limit itself. The default averaging threshold is adequate for most applications. If nuisance errors are seen when triggering or detraggering fluid, increase this parameter.
<b>Blanking Time</b> View or change on <a href="#">Setup Screen 9 (Blanking Time)</a> , page 44, Configuration C1	Range: 0.0–30.0 s by 0.1 Valid for all Presets. Arc detection is suppressed from when electrostatics are activated until the blanking time has elapsed. Adjust the setting to ensure the system reaches full voltage during the blanking time. If arc detection errors occur when the electrostatics are activated, increase the blanking time. Decrease the blanking time for greater sensitivity. Arc detection is deactivated during the blanking time. <ul style="list-style-type: none"> <li>• Activate the electrostatics only when the applicator is in SAFE POSITION.</li> <li>• Do not move the applicator out of the SAFE POSITION before the blanking time has elapsed and arc detection is active.</li> </ul> Use interlocking signals between the controller and the device performing the applicator's motion control. See <a href="#">SAFE POSITION Mode</a> , page 27 for more information.
<b>Transition Time</b> View or change on <a href="#">Setup Screen 11 (Transition Time)</a> , page 45, Configuration C3	Range: 0.0–5.0 s by 0.1 Valid for all Presets. Increase the transition time if arc detection errors occur when the voltage (or current) setpoint is changed. This setting helps eliminate nuisance arc detection errors during transition time.

\* Must be set for each Preset.

## Live Arc Detection Values

Press and hold the SEL button from Run Screen 1. The screen will change to Run Screen 2 when the button is pressed. Continue holding until the screen changes to Run Screen 3. Press the SEL button one more time to return to Run Screen 1. There should now be two additional numbers shown on the Screen.

On Run Screen 1, the top number is kV, the second number is uA, the third number is the live value for static arc detection, and the bottom number is the live value for dynamic arc detection.

During normal operation, the live arc detection values should be below the arc detection limits set on Run Screen 2. An arc detection error occurs when the live arc detection value exceeds arc detection limit setpoint. When an arc detection error occurs, the live arc detection values freeze on the screen. This will tell you what the maximum arc detection values were when the error occurred and will help to set the arc detection limits properly.

Watch the live static and dynamic arc values during normal operation. Set your static and dynamic arc detection limits slightly higher than the largest numbers seen on the screen.

If you are still experiencing a lot of nuisance arc detection errors, watch the static and dynamic arc values during a situation where a nuisance arc detection error occurs. (This is a situation where an arc detection error should not occur, but creates





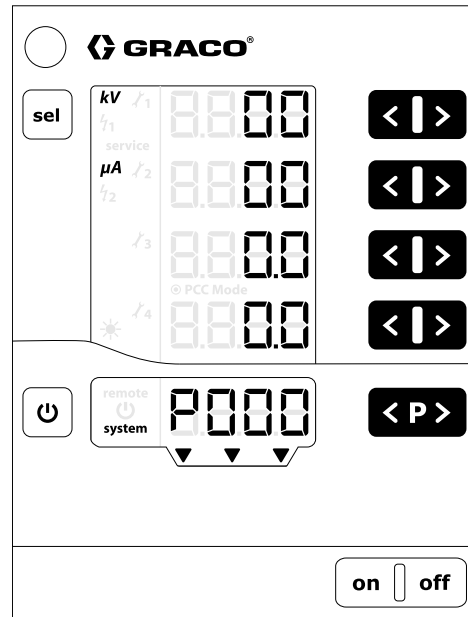



an error anyway.) Set your static and dynamic arc detection limits above the largest numbers seen on the screen.

NOTE: The live arc detection values must be enabled again if the controller loses power.

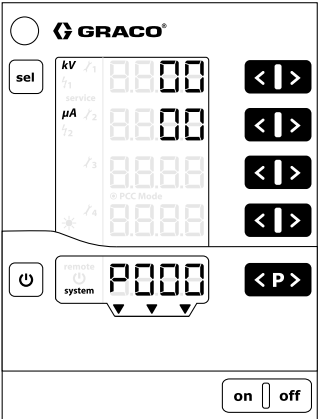
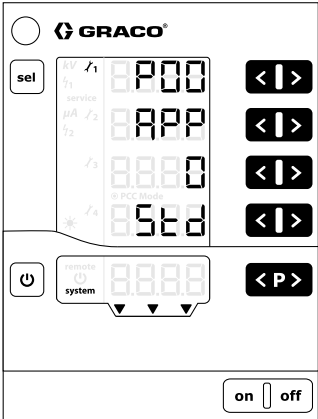
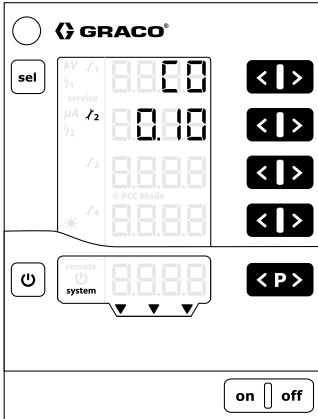

031211a

# Screen Map

<p><b>RUN</b></p> <p>Press and hold  for 5 seconds from any SETUP screen. Also shown on power up.</p>	<p><b>SETUP SCREENS 0-7 (Parameters)</b></p> <p>Press and hold  for 5 seconds from any RUN screen. Or, press  from SETUP SCREENS 8-11. Screens that are not implemented for the Pro Xpc Auto Controller are not shown.</p>	<p><b>SETUP SCREENS 8-11 (Configurations)</b></p> <p>Press  from SETUP SCREENS 0-7.</p>
	<p>Solventborne or Waterborne</p> 	
	 T1/T2	 T1/T2

RUN	SETUP SCREENS 0-7 (Parameters)	SETUP SCREENS 8-11 (Configurations)
<p style="text-align: center;">sel</p>	<p style="text-align: center;">← T1/T2</p>	<p style="text-align: center;">← T1/T2</p>
<p style="text-align: center;">sel</p>	<p style="text-align: center;">← T1/T2</p>	<p style="text-align: center;">← T1/T2</p>
	<p style="text-align: center;">← T1/T2</p>	<p style="text-align: center;">← T1/T2</p>

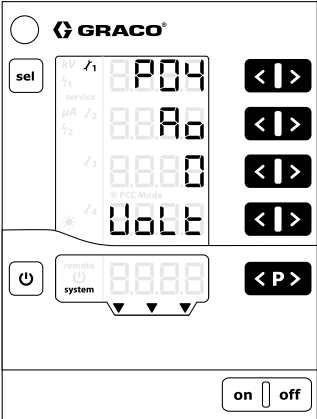
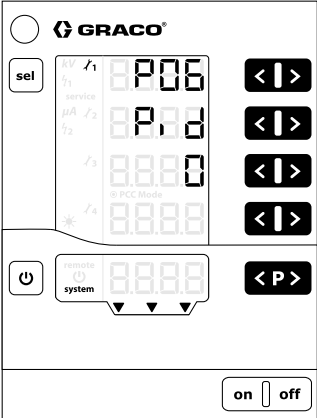
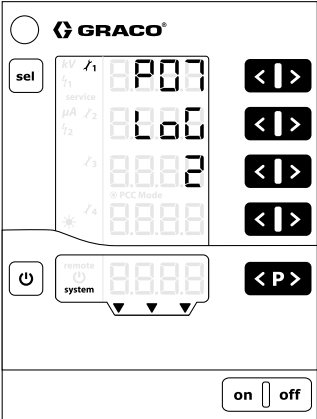
RUN	SETUP SCREENS 0-7 (Parameters)	SETUP SCREENS 8-11 (Configurations)
		
	<p style="text-align: center;">◀ T1/T2</p>	
		
	<p style="text-align: center;">◀ T1/T2</p>	
		
<p style="text-align: center;">◀ T1/T2</p>		

# Troubleshooting

## Error Codes

The Pro Xpc Auto Controller is monitored constantly. If a error is detected, an error message is indicated with a error code.

The error codes are shown in red on the **A5** display.



The four most recent error codes are stored by the order of their appearance. Each error in the list must be acknowledged with the **<P>** key. If an error code is shown, the **<P>** key cannot be used for other functions

The table below shows all possible error codes for the Pro Xpc Auto Controller.

## Reason Codes

In addition to the error message, some error codes (such as H11) have additional information displayed as a reason code. When an error code is shown

on the A5 display, press the **⏻** key and the **<P>** button at the same time to view the four-digit reason code. This reason code displays as long as the keys are held. If pressing these buttons does not show a four-digit reason code, the error code does not have a reason code. Contact Graco Technical Assistance for help diagnosing a reason code.

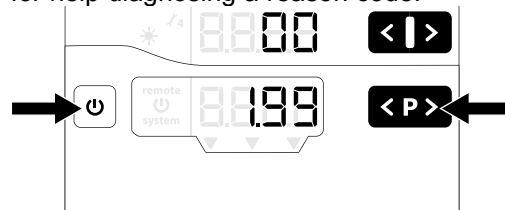

Code	Description	Criteria	Controller Action	Solution
<b>Electrostatics</b>				
H11	Gun failure	The controller does not detect a current from the gun, or detects a current that is too low.	Stop	<ul style="list-style-type: none"> <li>Verify the gun power cable connection. Perform <a href="#">Gun Power Cable Continuity, page 59</a>, and replace cable if needed.</li> <li>Replace gun power cable or gun power supply if needed.</li> </ul>
Reason Code: 0001				
Reason Code: 0002	Applicator Failure	The controller detects a current that is too high.	Stop	<ul style="list-style-type: none"> <li>Replace applicator power supply.</li> </ul>
Reason Code: 0003	Applicator Failure	The controller detects a high applicator temperature.	Stop	
Reason Code: 0004	Applicator Failure	The controller detects a high applicator input voltage.	Stop	



Code	Description	Criteria	Controller Action	Solution
H12	Spraying current offset high	The controller has detected a high off-state current. This error can occur during normal operation in waterborne systems during discharge or when multiple applicators are connected to the same fluid supply.	Stop	<ul style="list-style-type: none"> <li>Verify the applicator power cable connection, perform power cable continuity (see <a href="#">Gun Power Cable Continuity, page 59</a>), and replace the cable if needed.</li> <li>Replace the applicator power cable if needed.</li> <li>Verify all connections inside the controller.</li> <li>Replace the main board if needed.</li> <li>Verify system grounding.</li> </ul>
H13	Gun supply overvoltage	Gun voltage is too high.	Stop	<ul style="list-style-type: none"> <li>Verify the gun power cable connection. Perform <a href="#">Gun Power Cable Continuity, page 59</a>, and replace the cable if needed.</li> <li>Replace the gun power cable or gun power supply if needed.</li> </ul>
H14	Spraying current ground fault	The controller has detected a short between the chassis and the ground.	Stop	<ul style="list-style-type: none"> <li>Verify the applicator power cable connection. Perform <a href="#">Gun Power Cable Continuity, page 59</a>, and replace the cable if needed.</li> <li>Replace the applicator power cable if needed.</li> <li>Verify all connections inside the controller.</li> <li>Replace the main board if needed.</li> </ul>
H15	Arc detection static limit	The static arc detection threshold is exceeded. A grounded object came too close to the applicator.	Stop	<ul style="list-style-type: none"> <li>Verify the closest distances to parts.</li> <li>Verify paint conductivity.</li> <li>Verify spraying parameters associated with static arc detection, see <a href="#">Run Screen 2 (Arc Limits), page 48</a>.</li> </ul>
H16	Arc detection dynamic limit	Dynamic arc detection threshold exceeded. A grounded object approached the applicator at too high of a speed.	Stop	<ul style="list-style-type: none"> <li>Verify the fastest approach to parts.</li> <li>Verify paint conductivity.</li> <li>Verify spraying parameters associated with dynamic arc detection. See <a href="#">Run Screen 2 (Arc Limits), page 48</a>.</li> </ul>
H17	Arc detection both limits	A grounded object came too close to the applicator at too high of a speed.	Stop	<ul style="list-style-type: none"> <li>Verify the closest distances to parts.</li> <li>Verify the fastest approach to parts.</li> </ul>
H18	Arc detection unspecified	Arc detection triggered due to unspecified reason.	Stop	<ul style="list-style-type: none"> <li>Verify paint conductivity.</li> </ul>
H19	Arc detection drive voltage	The power supply drive voltage rose too quickly.	Stop	<ul style="list-style-type: none"> <li>Verify spraying parameters associated with arc detection. See <a href="#">Run Screen 2 (Arc Limits), page 48</a>.</li> </ul>
H91	Power Supply Communication Error	Communication between controller and power supply failed.	Stop	<ul style="list-style-type: none"> <li>Verify the gun power cable connection. Perform <a href="#">Gun Power Cable Continuity, page 59</a>, and replace cable if needed.</li> <li>Replace gun power cable or gun power supply if needed.</li> </ul>
<b>Internal Controller Errors</b>				

## Troubleshooting

Code	Description	Criteria	Controller Action	Solution
H20	Controller mainboard voltage tolerance	Onboard generated voltage is out of tolerance	None	<ul style="list-style-type: none"> <li>Verify that all connections inside of controller are properly made.</li> <li>Verify the power source.</li> </ul>
H21	Controller mainboard voltage failure	24V supply drops below 21V. Remark: No error code is displayed	Shutdown	<ul style="list-style-type: none"> <li>Replace the 24VDC board or power board if needed.</li> </ul>
H24	Memory contents invalid	Magic number doesn't match expected value	Initialize defaults	<ul style="list-style-type: none"> <li>Verify all connections inside the controller.</li> </ul>
H25	Memory write timeout	Writing to EEPROM takes longer than 10ms	None	<ul style="list-style-type: none"> <li>Replace the main board if needed.</li> </ul>
H26	Memory shutdown error	Data to be written at power off hasn't been properly saved to the EEPROM	None	<ul style="list-style-type: none"> <li>Do not turn off the controller so quickly after making setting changes.</li> <li>Verify all connections inside the controller.</li> <li>Replace main board if needed.</li> </ul>
H27	Memory verify failure	Verification of the data written to the EEPROM failed	None	<ul style="list-style-type: none"> <li>Verify all connections inside the controller.</li> <li>Replace the main board if needed.</li> </ul>
H80	Safety controller communication Error	No response/timeout to a request. Error report on command execution. Response data mismatch	Stop	<ul style="list-style-type: none"> <li>Verify all connections inside the controller.</li> <li>Verify the software version and update if needed.</li> </ul>
H81	Safety controller self-test failure	The self-test performed by the safety controller detected an error	Stop	<ul style="list-style-type: none"> <li>Replace the main board if needed.</li> </ul>
H82	Safety controller not alive	Heartbeat message timeout	Stop	
H90	Gun controller communication error	No response/timeout to a request. Error report on command execution. Response data mismatch	None	
H92	Gun controller not alive	Heartbeat message timeout	Stop	
H94	Gun controller update required.	The gun controller firmware requests an update.	None	<ul style="list-style-type: none"> <li>Verify the software version and update if needed.</li> </ul>
H95	Invalid applicator type detected	The incorrect power supply is connected to the controller	Stop	<ul style="list-style-type: none"> <li>Verify that the power supply is meant to be used with this controller.</li> </ul>
<b>Graco CAN Bus Errors</b>				
H40	CAN Bus Off	The CAN controller went to bus off state due to permanent bus error.	Stop	<ul style="list-style-type: none"> <li>Verify that parameter P02 on Setup Screen 2 is set to CAN mode and parameter P06 on Setup Screen 6 is correct.</li> </ul>
H41	CAN Error Passive	The CAN controller went to error passive state due to repeated bus errors.	Stop	<ul style="list-style-type: none"> <li>Verify CAN cable connections.</li> </ul>
H42	CAN receive overflow	CAN messages are arriving too quickly.	Stop	<ul style="list-style-type: none"> <li>Verify that CAN devices are connected and functioning.</li> </ul>
H43	CAN receive FIFO overflow	CAN messages arrive faster than they can be transferred to the receive queue.	Stop	<ul style="list-style-type: none"> <li>Replace the CAN board, if necessary.</li> </ul>
H44	Remote enable communications error	The CAN remote enable heartbeat has stopped being transmitted.	Stop	
<b>Other Errors</b> These will be logged, but not likely to be seen on the display due to restart				

Code	Description	Criteria	Controller Action	Solution
H901	Assertion failed	Violation of a mandatory precondition	Restart	<ul style="list-style-type: none"> <li>• Verify all connections inside the controller.</li> <li>• Restart the controller.</li> <li>• Verify the software version and update if needed.</li> <li>• Replace the main board if needed.</li> </ul>
H902	Out of memory	Memory allocation failed	Restart	
H903	Watchdog timeout	Watchdog wasn't serviced timely	Restart	
H904	Stack Overflow	A stack overflow has been detected.	Restart	
H905	Hard fault error	The CPU detected a hard fault	Restart	
H999	Other fatal error	Unspecified fatal error	Restart	

## Gun Power Cable Continuity

To ensure that the gun power cable has not been damaged, it may be necessary to verify the electrical integrity of the cable. To check continuity, perform the following:

1. Power down the system.
2. Remove the gun power cable.

3. Refer to the cable schematic in [Connections, page 16](#). Use an ohmmeter to check each pin at each connector against all other listed pins to verify continuity where indicated, or isolation between other pins.

# Repair

Individual items used in this controller are not repairable. If they fail, they must be replaced. See [Parts, page 67](#), for a list of repair kits.

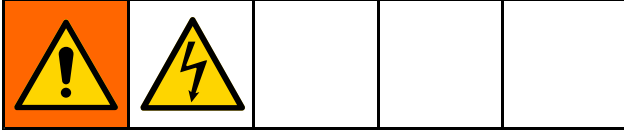

## NOTICE

To avoid damaging the circuit boards when servicing the control box, wear Part No. 112190 grounding strap on your wrist and ground appropriately each time.

## Power Board Fuse Replacement

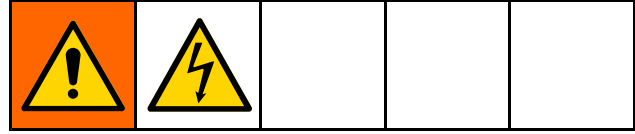

1. Remove power from the system. Follow the appropriate lock-out/tag-out procedures.
2. Using a Phillips head screwdriver, loosen the four screws holding the front access cover in place. Carefully remove the front access cover.

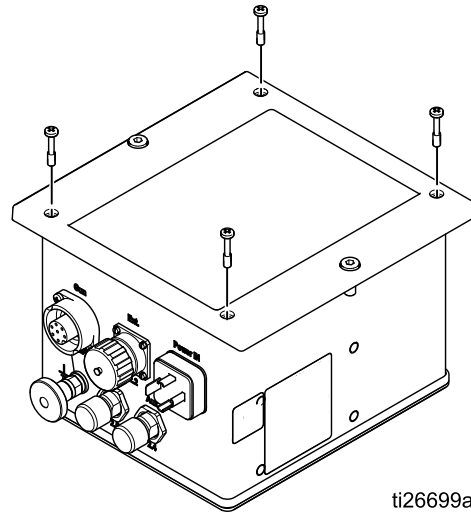

3. Locate the power board and the fuse F1.

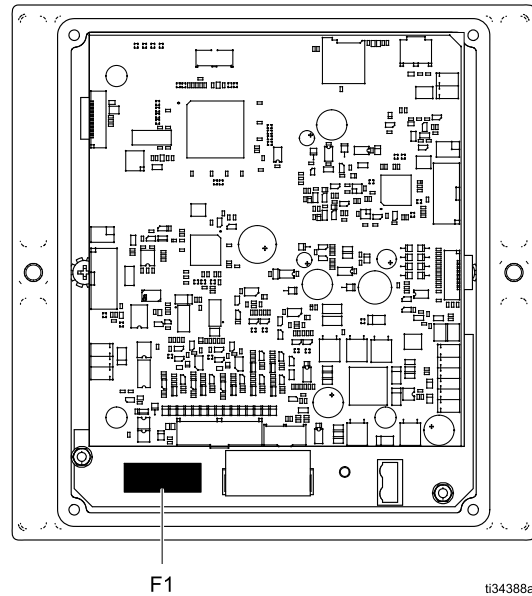

4. Remove the cover from fuse F1 by gently squeezing the cover lengthwise.

- Verify that the fuse is blown. Use a multimeter in Ohms Mode or Conductivity Mode. Place a multimeter lead on either side of the fuse on the metal caps. A blown fuse reads as open. A working fuse reads as <10 Ohms or shorted.

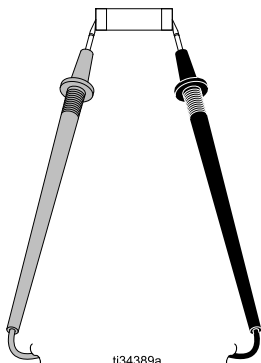

- If blown, remove the failed fuse F1 from the holder by pulling up on the fuse. Replace the blown fuse with a new fuse of the specified type, current, and voltage rating.

Replacement Fuse Kit	25E312 (Qty 5)
Type	Ceramic 5x20mm Time-Lag T
Current	2A
Voltage Rating	250VAC/300VDC

- Place the fuse cover over the fuse and holder. Press to snap into place.
- Replace the controller access cover.
- Screw down the front access cover.
- Reapply power. Switch on the controller.

## Main Circuit Board, Power Board, LED Panel, or Keypad Membrane Removal

- Remove all outside connections from the controller.
- Remove the controller from its mounting surface or bracket using the 4 mm (1/8") Allen wrench. NOTE: Service is best accomplished if the controller is on a workbench.
- Using the Phillips head screwdriver, loosen the four screws holding the front access cover in place. Carefully remove the front access cover.

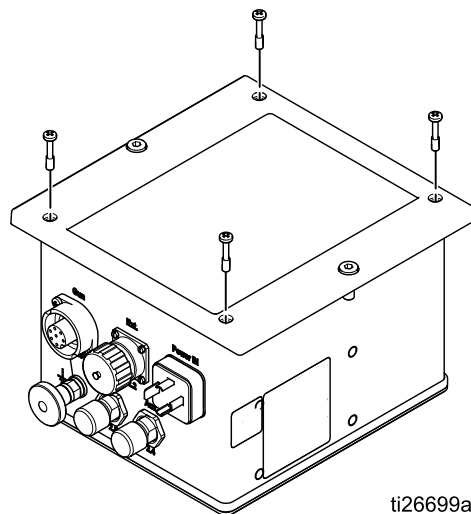

## Repair

### 4. Remove connections on the main board.

- Remove the three green connectors (G). Gently wiggle the connectors from side to side to loosen and remove by hand.
- Unlock the three black connectors (B) using a flat head screwdriver. Gently wiggle the connectors from side to side to loosen and remove by hand.
- Remove the strain relief band from the two white ribbon cables (W). Unlock the ribbon cables by gently wiggling the top of the connector upwards until it snaps out of position. (The connector stays on the board.) Then gently pull the ribbon cable out of the connector.

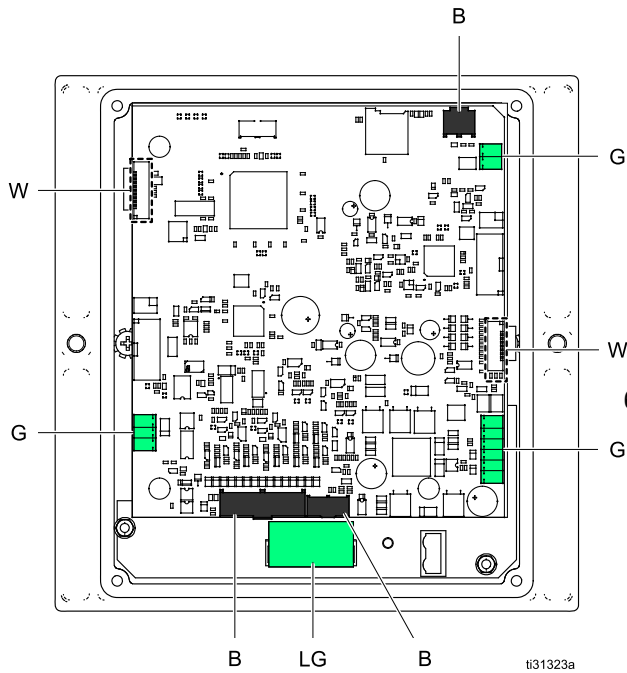

### 5. For easier service, remove the cable connections to the power board (PB) and power supply board (PS). (The power supply is in the controller housing.)

- Remove the large green connector (LG) on the power board. This is mounted below the main board. Gently wiggle the connector from side to side to loosen and remove by hand.
- Remove the white connector (WC) from inside the controller housing that goes to the power supply. Gently wiggle the connector from side to side to loosen and remove by hand.

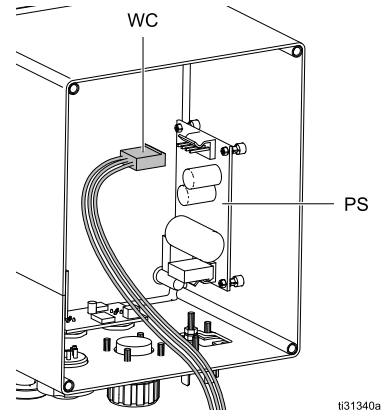

### 6. The main board is held in place by four acorn nuts (AC) and four washers. Using the 5 mm (7/32") socket, remove the nuts and washers and carefully lift the board off the standoffs.

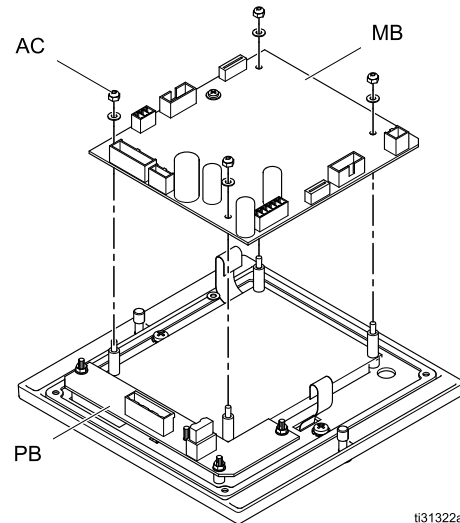

- The power board is held in place by four acorn nuts (AC) and four washers. If the power board needs to be replaced, using the 5 mm (7/32") socket, remove the nuts and washers and carefully lift the board off the standoffs.

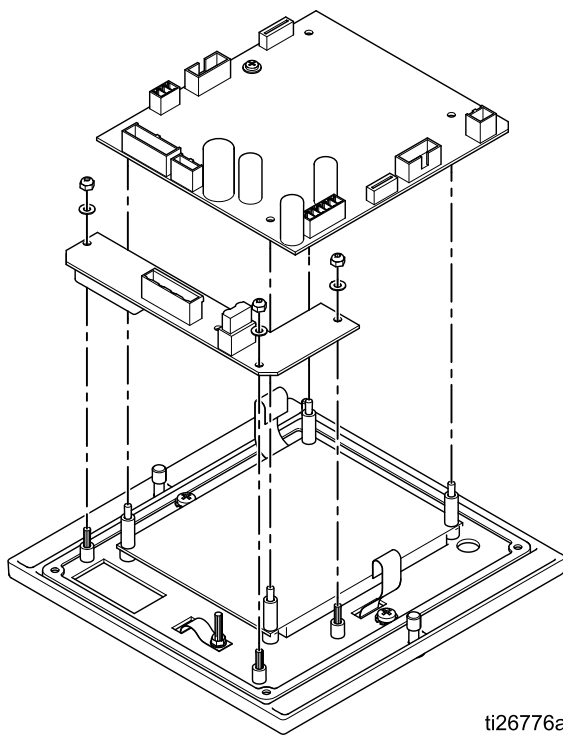

- If the LCD panel needs to be replaced, remove the four spacers and lift the LCD panel off the standoffs.

- If the keypad membrane needs to be replaced, remove the two Phillips head screws and lift out the membrane panel.

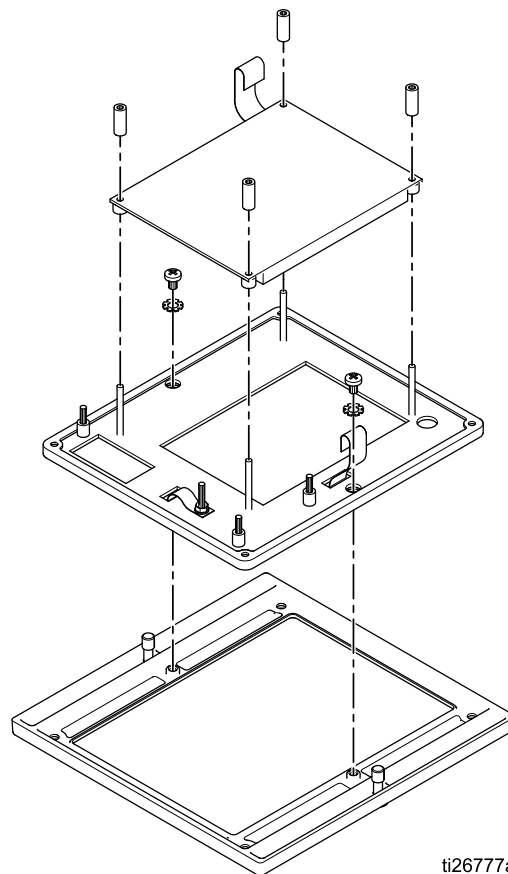

- If you removed the membrane panel, replace the membrane panel and tighten the two Phillips head screws.
- If you removed the LCD panel, orient the LCD panel properly and place it on the standoffs. Replace the four spacers on the standoffs.
- If you removed the power board, orient the power board properly and place it on the standoffs. Replace the washers and acorn nuts on each standoff. Tighten by hand.
- If you removed the main board, orient the main board properly and place it on the standoffs. Replace the washers and acorn nuts on each standoff. Tighten by hand.

## Repair

14. If you removed the cable connections, replace the two additional cable connections to the power board (PB) and power supply board (PS).
  - a. Replace the large green (LG) connector on the power board. This is mounted below the main board (MB). Note the keying features and push into place by hand.
  - b. Replace the white connector (WC) on the power supply board. This is mounted on the inside of the controller housing. Note the keying features and push into place by hand.
15. Replace connections on the main board.
  - a. Replace the three main board green connections (G). Note the keying features and push into place by hand.
  - b. Replace the three main board black connections (B). Note the keying features and push into place by hand.
  - c. Replace the two main board white ribbon connections (W). Make sure the top of the connector is loose by gently pulling upwards on the connector.
  - d. Push the ribbon cable into the connector until it bottoms out.
  - e. Push the top of the connector down onto the board until it locks.
  - f. Replace the strain relief band over the ribbon cable and connector.
  - g. Verify the ribbon cable is locked in place by gently pulling on it.
16. When all connections are made, gently replace the front access cover on the connector housing. Make sure that no cables are pinched in the process.
17. Using the Phillips head screwdriver, tighten the four screws holding the front access cover in place.
18. Replace the outside connections to the controller. Connect the power, turn on the controller, and reload settings before returning to service.



## Power Board Removal

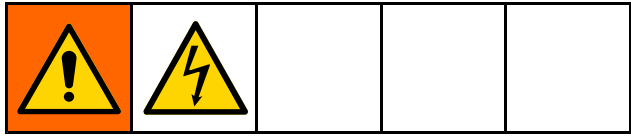

1. Remove power from the system.
2. Remove four screws, then remove the back access panel.

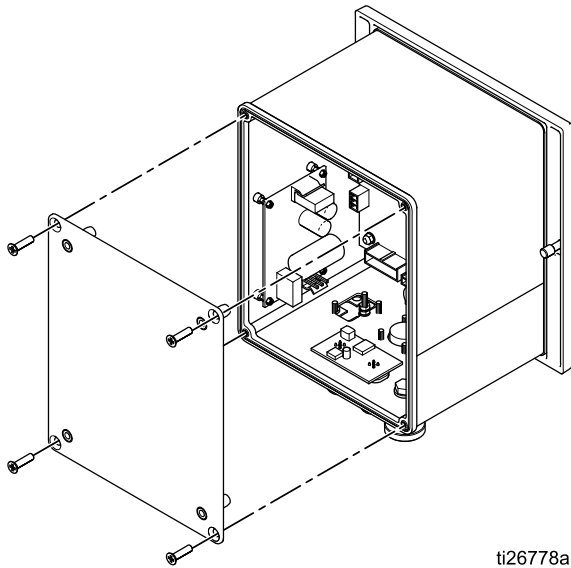

ti26778a

3. Remove the two electrical connectors from the power board, as shown.

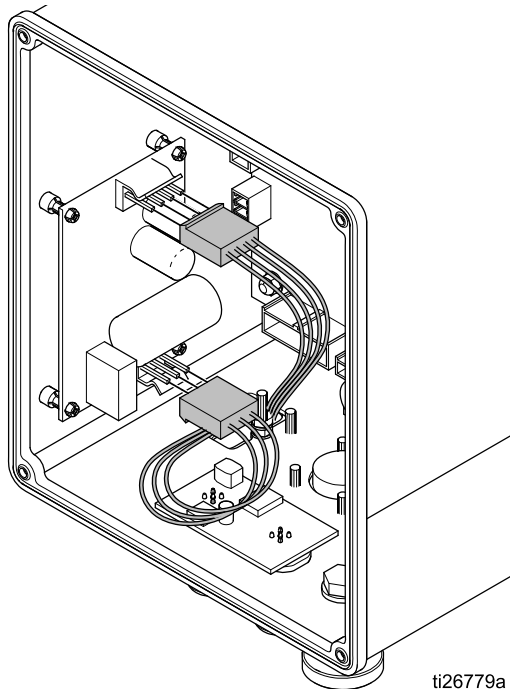

ti26779a

4. Gently pry the power board from the four retaining clips and remove the board, as shown.

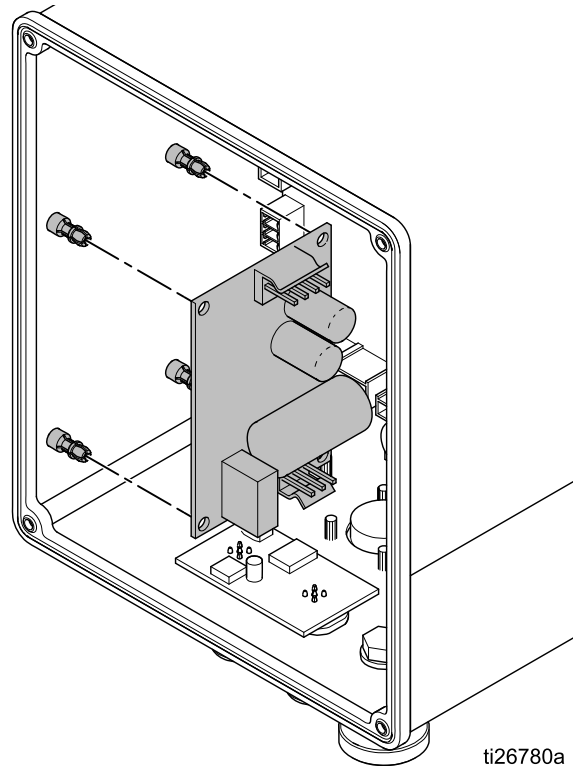

ti26780a

## Software Update



**NOTE:** Prior to beginning a software update, make a written copy of Preset settings that have been defined for use with the specific materials being applied with this system. This will ensure that the information is recoverable in the event the software update resets Presets to factory settings.

1. Obtain the software update files, (17B730.zip). Unzip the file. There may be one or more files required for the update. Put all files in the root directory of a microSD card.

**NOTE:** If a microSD card is already in the main board, this step will need to be performed after step 4.

**NOTE:** There are limitations to the memory size of the microSD card that can be supported.

Type	Maximum
SD	2 GB
SDHC	32 GB
Do not use SDXC cards unless they are formatted to FAT32 file format.	

2. Switch off the Pro Xpc Auto Controller and remove power from the system.
3. Remove four screws, then remove the controller access cover.

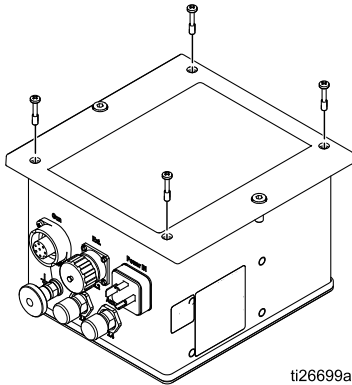

4. Find the microSD card slot on the top of the main board, and insert the microSD card with the software update.

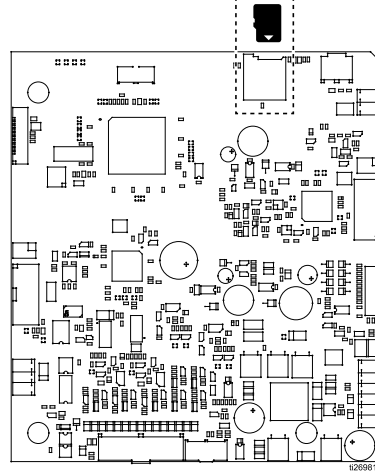

5. Carefully place the controller access cover onto the controller box. Do not screw down.
6. Apply power to the Pro Xpc Auto Controller and press the **on** button. The screen should blink and display **donE** when the reprogramming is complete.

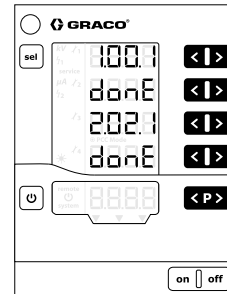

7. Press any button to return to normal operation.
8. Verify the software version by holding **U** and **P>** at the same time.
9. Switch off the Pro Xpc Auto Controller and remove power from the system.
10. If desired, remove the microSD card from the slot, or replace the microSD card with another. Having a microSD card in the slot will allow the controller to store log files. See [Setup Screen 7 \(Log Level\)](#), page 43 for information about logging.
11. Replace the controller access cover.
12. Screw down the front access cover.
13. Reapply power and switch on the Pro Xpc Auto Controller.

# Parts

## Pro Xpc Auto Controller 24Y307 (solventborne system) and 24Y308 (waterborne system)

Part No.	Description
17H039	Discrete I/O Cable (included)
223547	Ground Wire (included)
24Y335	Pro Xpc Auto Controller Power Cord (included)

## Repair Kits

See [Repair, page 60](#), for instructions on removal and installation.

Kit Number	Description
17H287	Main Board, <i>solventborne system only</i>
17H661	Main Board, <i>waterborne system only</i>
17H286	Power Board
17H285	Power Supply Board
17H283	Button Panel
17H282	LCD Panel
25E312	Power Board Fuse (Qty 5)

## Accessories

### Gun Power Cables

Part No.	Description
17J586	Gun Power Cable; 11 m (36 ft)
17J588	Gun Power Cable; 20 m (65.6 ft)
17J589	Gun Power Cable; 30 m (98.4 ft)

### Mounting Brackets

Part No.	Description
17H288	Bracket, wall mounting, for 24Y307, 24Y308

## Software

Part No.	Description
17B730	Software, main board
The software does not affect the portion of controller memory that defines the type of system.	

# Dimensions

## Controller

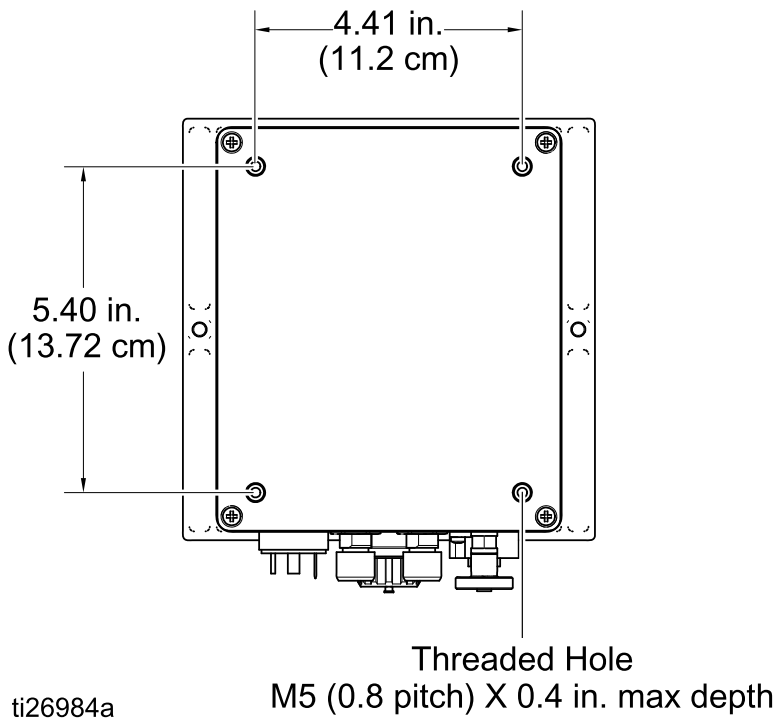
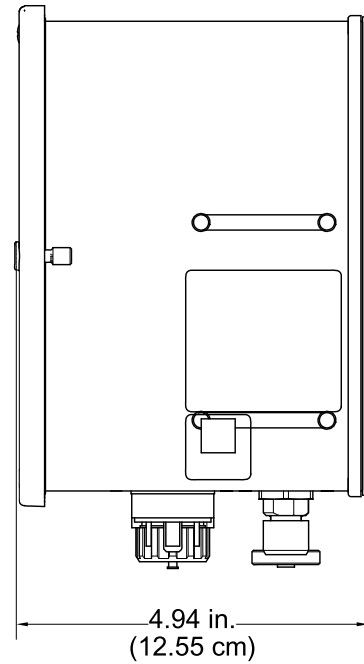
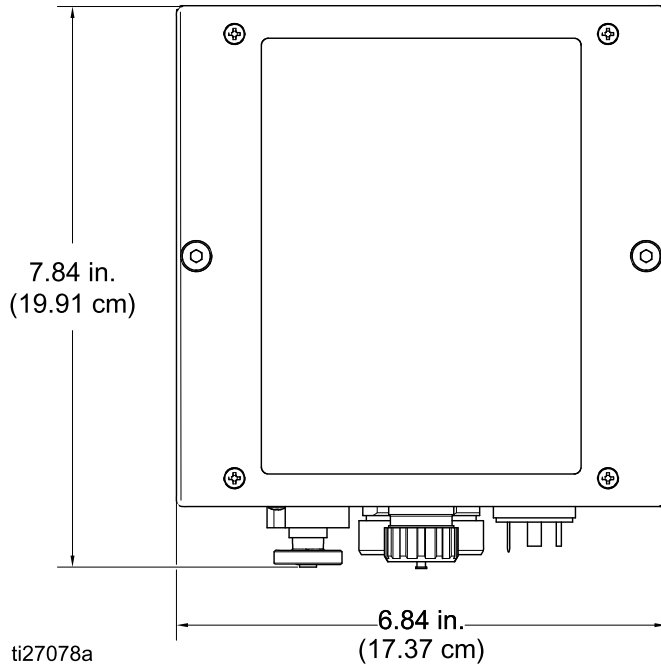

### Flush Mount

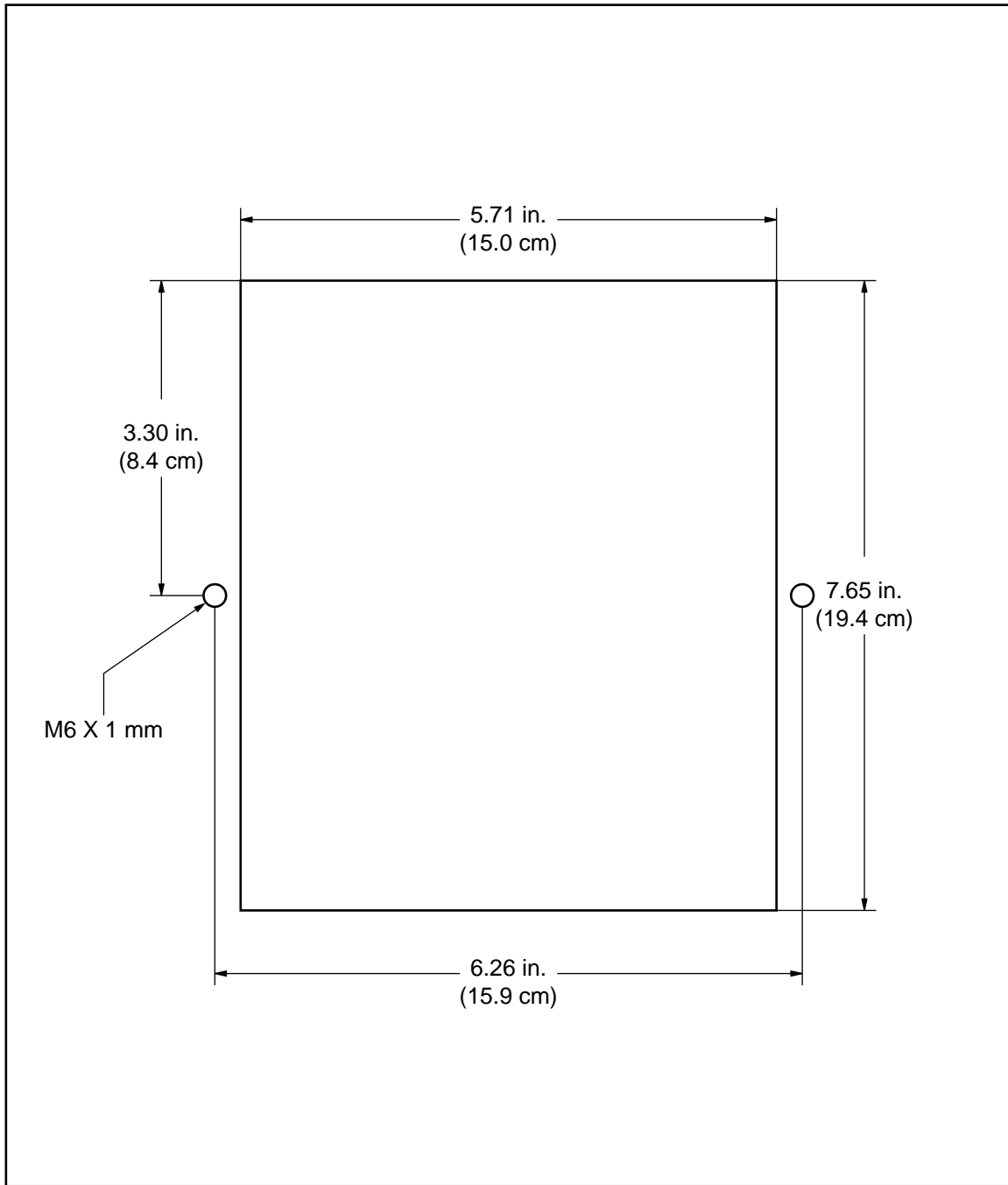

*Dimensions*

**Wall Mount Bracket 17H288**

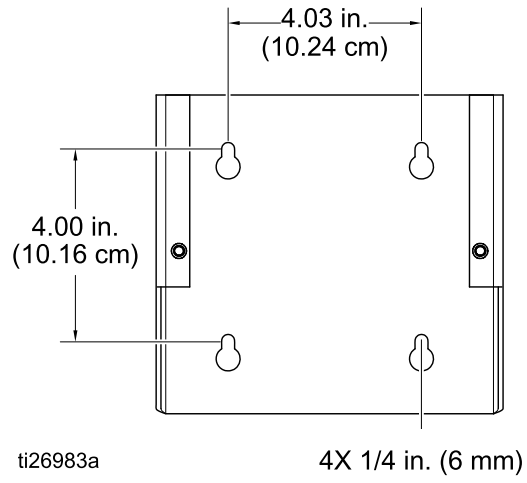

# Technical Specifications

Pro Xpc Auto Controller		
	U.S.	Metric
Nominal Input Voltage	100–240 VAC	
Frequency	50–60 Hz	
Input Power	40 VA	
Nominal Output Voltage (to the gun)	eff 10V	
Nominal Output Current (to the gun)	max 1.2 A	
Protection Type	IP54	
Ambient Temperature Range	41°F - 104°F	5°C - 40°C
Dimensions		
Width	6.8 in.	173 mm
Depth	4.8 in.	122 mm
Height	7.5 in.	191 mm
Weight	approx. 4.5 lbs.	approx. 2.0 kg

# Graco Standard Warranty

Graco warrants all equipment referenced in this document which is manufactured by Graco and bearing its name to be free from defects in material and workmanship on the date of sale to the original purchaser for use. With the exception of any special, extended, or limited warranty published by Graco, Graco will, for a period of twelve months from the date of sale, repair or replace any part of the equipment determined by Graco to be defective. This warranty applies only when the equipment is installed, operated and maintained in accordance with Graco's written recommendations.

This warranty does not cover, and Graco shall not be liable for general wear and tear, or any malfunction, damage or wear caused by faulty installation, misapplication, abrasion, corrosion, inadequate or improper maintenance, negligence, accident, tampering, or substitution of non-Graco component parts. Nor shall Graco be liable for malfunction, damage or wear caused by the incompatibility of Graco equipment with structures, accessories, equipment or materials not supplied by Graco, or the improper design, manufacture, installation, operation or maintenance of structures, accessories, equipment or materials not supplied by Graco.

This warranty is conditioned upon the prepaid return of the equipment claimed to be defective to an authorized Graco distributor for verification of the claimed defect. If the claimed defect is verified, Graco will repair or replace free of charge any defective parts. The equipment will be returned to the original purchaser transportation prepaid. If inspection of the equipment does not disclose any defect in material or workmanship, repairs will be made at a reasonable charge, which charges may include the costs of parts, labor, and transportation.

**THIS WARRANTY IS EXCLUSIVE, AND IS IN LIEU OF ANY OTHER WARRANTIES, EXPRESS OR IMPLIED, INCLUDING BUT NOT LIMITED TO WARRANTY OF MERCHANTABILITY OR WARRANTY OF FITNESS FOR A PARTICULAR PURPOSE.**

Graco's sole obligation and buyer's sole remedy for any breach of warranty shall be as set forth above. The buyer agrees that no other remedy (including, but not limited to, incidental or consequential damages for lost profits, lost sales, injury to person or property, or any other incidental or consequential loss) shall be available. Any action for breach of warranty must be brought within two (2) years of the date of sale.

**GRACO MAKES NO WARRANTY, AND DISCLAIMS ALL IMPLIED WARRANTIES OF MERCHANTABILITY AND FITNESS FOR A PARTICULAR PURPOSE, IN CONNECTION WITH ACCESSORIES, EQUIPMENT, MATERIALS OR COMPONENTS SOLD BUT NOT MANUFACTURED BY GRACO.** These items sold, but not manufactured by Graco (such as electric motors, switches, hose, etc.), are subject to the warranty, if any, of their manufacturer. Graco will provide purchaser with reasonable assistance in making any claim for breach of these warranties.

In no event will Graco be liable for indirect, incidental, special or consequential damages resulting from Graco supplying equipment hereunder, or the furnishing, performance, or use of any products or other goods sold hereto, whether due to a breach of contract, breach of warranty, the negligence of Graco, or otherwise.

## FOR GRACO CANADA CUSTOMERS

The Parties acknowledge that they have required that the present document, as well as all documents, notices and legal proceedings entered into, given or instituted pursuant hereto or relating directly or indirectly hereto, be drawn up in English. Les parties reconnaissent avoir convenu que la rédaction du présente document sera en Anglais, ainsi que tous documents, avis et procédures judiciaires exécutés, donnés ou intentés, à la suite de ou en rapport, directement ou indirectement, avec les procédures concernées.

## Graco Information

For the latest information about Graco products, visit [www.graco.com](http://www.graco.com). For patent information, see [www.graco.com/patents](http://www.graco.com/patents).

**To place an order**, contact your Graco Distributor or call to identify the nearest distributor.

**Phone:** 612-623-6921 **or Toll Free:** 1-800-328-0211 **Fax:** 612-378-3505

All written and visual data contained in this document reflects the latest product information available at the time of publication.

Graco reserves the right to make changes at any time without notice.

Original Instructions. This manual contains English, MM 333266

**Graco Headquarters:** Minneapolis

**International Offices:** Belgium, China, Japan, Korea

**GRACO INC. AND SUBSIDIARIES • P.O. BOX 1441 • MINNEAPOLIS, MN 55440-1441 • USA**

**Copyright 2015, Graco Inc. All Graco manufacturing locations are registered to ISO 9001.**

[www.graco.com](http://www.graco.com)  
Revision L, 2019-01