

FinishPro II 395 PC Airless/Air-Assisted Sprayer

334730F

EN

For professional use only.

Not approved for use in explosive atmospheres or hazardous locations.

For portable application of architectural paints and coatings.

Models: 17C417, 17C418, 17C421, 17C320, 17C321
3300 psi (228 bar, 22.8 MPa) Maximum Working Pressure

See page 3 for additional model information.



Important Safety Instructions

Read all warnings and instructions in this manual and related manuals.
Be familiar with the controls and the proper usage of the equipment.
Save these instructions.

Related Manuals

Gun - 333182

Pump - 334599

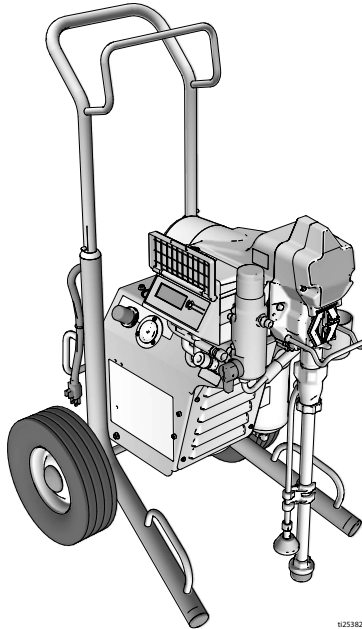

025382a



Use only genuine Graco replacement parts.

The use of non-Graco replacement parts may void warranty.

Contents

Models	3
Warnings	4
Component Identification	8
Grounding	9
Power Requirements	9
Extension Cords	9
Pails	9
Pressure Relief Procedure	10
Setup	12
Startup	15
Operation	17
Spray Tip Installation	17
Spray	18
Clear Tip Clog	20
Digital Display	21
Cleanup	23
Maintenance	26
Troubleshooting	27
Mechanical/Fluid Flow	27
Electrical	30
Sprayer	39
Sprayers Parts List	41
Control and Filter	42
Control and Filter Parts List	43
Compressor	44
Compressor Parts List	45
Wiring Diagrams	46
120V, US/110V, UK	46
230V	47
Technical Specifications	48
Graco Standard Warranty	50
Graco Information	51

Models

	VAC	Model	
 Intertek 110474 Certified to CAN/CSA C22.2 No. 68 Conforms to UL 1450	120 USA	FinishPro II 395 PC	17C417
	230 CEE 7/7	FinishPro II 395 PC	17C418
	230 Europe Multicord	FinishPro II 395 PC	17C421
	110 UK	FinishPro II 395 PC	17C320
	230 Asia/ANZ	FinishPro II 395 PC	17C321
	230 China		

Warnings

The following warnings are for the setup, use, grounding, maintenance, and repair of this equipment. The exclamation point symbol alerts you to a general warning and the hazard symbols refer to procedure-specific risks. When these symbols appear in the body of this manual or on warning labels, refer back to these Warnings. Product-specific hazard symbols and warnings not covered in this section may appear throughout the body of this manual where applicable.

WARNING



GROUNDING

This product must be grounded. In the event of an electrical short circuit, grounding reduces the risk of electric shock by providing an escape wire for the electric current. This product is equipped with a cord having a grounding wire with an appropriate grounding plug. The plug must be plugged into an outlet that is properly installed and grounded in accordance with all local codes and ordinances.

- Improper installation of the grounding plug is able to result in a risk of electric shock.
- When repair or replacement of the cord or plug is required, do not connect the grounding wire to either flat blade terminal.
- The wire with insulation having an outer surface that is green with or without yellow stripes is the grounding wire.
- Check with a qualified electrician or serviceman when the grounding instructions are not completely understood, or when in doubt as to whether the product is properly grounded.
- Do not modify the plug provided; if it does not fit the outlet, have the proper outlet installed by a qualified electrician.
- This product is for use on a nominal 120V or 230V circuit and has a grounding plug similar to the plugs illustrated below.

120V US



230V

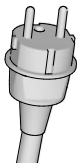

230V ANZ

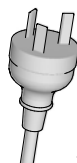

ti24583a

- Only connect the product to an outlet having the same configuration as the plug.
- Do not use an adapter with this product.

Extension Cords:

- Use only a 3-wire extension cord that has a grounding plug and a grounding receptacle that accepts the plug on the product.
- Make sure your extension cord is not damaged. If an extension cord is necessary use 12 AWG (2.5mm²) minimum to carry the current that the product draws.
- An undersized cord results in a drop in line voltage and loss of power and overheating.

WARNING
**FIRE AND EXPLOSION HAZARD**

Flammable fumes, such as solvent and paint fumes, in work area can ignite or explode. To help prevent fire and explosion:



- Do not spray flammable or combustible materials near an open flame or sources of ignition such as cigarettes, motors, and electrical equipment.



- Paint or solvent flowing through the equipment is able to result in static electricity. Static electricity creates a risk of fire or explosion in the presence of paint or solvent fumes. All parts of the spray system, including the pump, hose assembly, spray gun, and objects in and around the spray area shall be properly grounded to protect against static discharge and sparks. Use Graco conductive or grounded high-pressure airless paint sprayer hoses.



- Verify that all containers and collection systems are grounded to prevent static discharge. Do not use pail liners unless they are anti-static or conductive.
- Connect to a grounded outlet and use grounded extensions cords. Do not use a 3-to-2 adapter.
- Do not use a paint or a solvent containing halogenated hydrocarbons.
- Do not spray flammable or combustible liquids in a confined area.
- Keep spray area well-ventilated. Keep a good supply of fresh air moving through the area.
- Sprayer generates sparks. Keep pump assembly in a well ventilated area at least 20 feet (6.1 m) from the spray area when spraying, flushing, cleaning, or servicing. Do not spray pump assembly.
- Do not smoke in the spray area or spray where sparks or flame is present.
- Do not operate light switches, engines, or similar spark producing products in the spray area.
- Keep area clean and free of paint or solvent containers, rags, and other flammable materials.
- Know the contents of the paints and solvents being sprayed. Read all Safety Data Sheets (SDS) and container labels provided with the paints and solvents. Follow the paint and solvents manufacturer's safety instructions.
- Fire extinguisher equipment shall be present and working.

WARNING



SKIN INJECTION HAZARD

High-pressure spray is able to inject toxins into the body and cause serious bodily injury. In the event that injection occurs, **get immediate surgical treatment.**



- Do not aim the gun at, or spray any person or animal.
- Keep hands and other body parts away from the discharge. For example, do not try to stop leaks with any part of the body.
- Always use the nozzle tip guard. Do not spray without nozzle tip guard in place.
- Use Graco nozzle tips.
- Use caution when cleaning and changing nozzle tips. In the case where the nozzle tip clogs while spraying, follow the **Pressure Relief Procedure** for turning off the unit and relieving the pressure before removing the nozzle tip to clean.
- Equipment maintains pressure after power is shut off. Do not leave the equipment energized or under pressure while unattended. Follow the **Pressure Relief Procedure** when the equipment is unattended or not in use, and before servicing, cleaning, or removing parts.
- Check hoses and parts for signs of damage. Replace any damaged hoses or parts.
- This system is capable of producing 3300 psi. Use Graco replacement parts or accessories that are rated a minimum of 3300 psi.
- Always engage the trigger lock when not spraying. Verify the trigger lock is functioning properly.
- Verify that all connections are secure before operating the unit.
- Know how to stop the unit and bleed pressure quickly. Be thoroughly familiar with the controls.



EQUIPMENT MISUSE HAZARD

Misuse can cause death or serious injury.



- Always wear appropriate gloves, eye protection, and a respirator or mask when painting.
- Do not operate or spray near children. Keep children away from equipment at all times.
- Do not overreach or stand on an unstable support. Keep effective footing and balance at all times.
- Stay alert and watch what you are doing.
- Do not operate the unit when fatigued or under the influence of drugs or alcohol.
- Do not kink or over-bend the hose.
- Do not expose the hose to temperatures or to pressures in excess of those specified by Graco.
- Do not use the hose as a strength member to pull or lift the equipment.
- Do not spray with a hose shorter than 25 feet.
- Do not alter or modify equipment. Alterations or modifications may void agency approvals and create safety hazards.
- Make sure all equipment is rated and approved for the environment in which you are using it.

⚠️ WARNING



ELECTRIC SHOCK HAZARD

This equipment must be grounded. Improper grounding, setup, or usage of the system can cause electric shock.

- Turn off and disconnect power cord before servicing equipment.
- Connect only to grounded electrical outlets.
- Use only 3-wire extension cords.
- Ensure ground prongs are intact on power and extension cords.
- Do not expose to rain. Store indoors.



PRESSURIZED ALUMINUM PARTS HAZARD

Use of fluids that are incompatible with aluminum in pressurized equipment can cause serious chemical reaction and equipment rupture. Failure to follow this warning can result in death, serious injury, or property damage.

- Do not use 1,1,1-trichloroethane, methylene chloride, other halogenated hydrocarbon solvents or fluids containing such solvents.
- Do not use chlorine bleach.
- Many other fluids may contain chemicals that can react with aluminum. Contact your material supplier for compatibility.



MOVING PARTS HAZARD

Moving parts can pinch, cut, or amputate fingers and other body parts.

- Keep clear of moving parts.
- Do not operate equipment with protective guards or covers removed.
- Pressurized equipment can start without warning. Before checking, moving, or servicing equipment, follow the **Pressure Relief Procedure** and disconnect all power sources.



TOXIC FLUID OR FUMES HAZARD

Toxic fluids or fumes can cause serious injury or death if splashed in the eyes or on skin, inhaled, or swallowed.

- Read SDSs to know the specific hazards of the fluids you are using.
- Store hazardous fluid in approved containers, and dispose of it according to applicable guidelines.



PERSONAL PROTECTIVE EQUIPMENT

Wear appropriate protective equipment when in the work area to help prevent serious injury, including eye injury, hearing loss, inhalation of toxic fumes, and burns. This protective equipment includes but is not limited to:

- Protective eyewear, and hearing protection.
- Respirators, protective clothing, and gloves as recommended by the fluid and solvent manufacturer.



BURN HAZARD

Equipment surfaces and fluid that is heated can become very hot during operation. To avoid severe burns:

- Do not touch hot fluid or equipment.

CALIFORNIA PROPOSITION 65

This product contains a chemical known to the State of California to cause cancer, birth defects or other reproductive harm. Wash hands after handling.

Component Identification

Component Identification

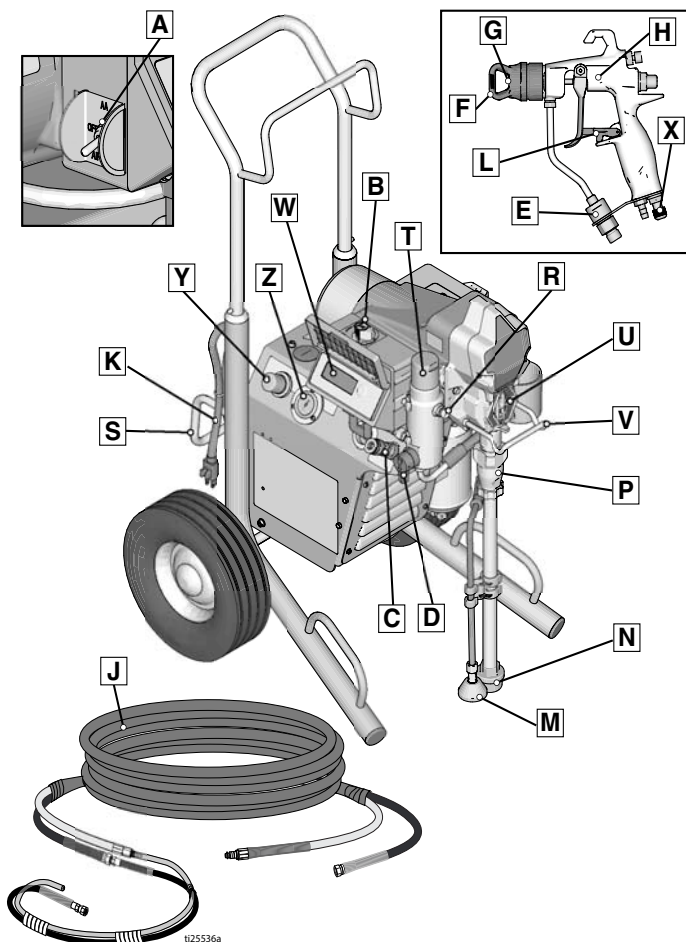

A	Power/Function Selector
B	Pressure Control
C	Air Hose Connection
D	Prime Valve
E	Gun Filter
F	Tip Guard
G	Spray Tip
H	Gun
J	Airless Hose
K	Power Cord
L	Trigger Lock
M	Drain Tube

N	Fluid Intake
P	Pump
R	Fluid Outlet
S	Hanger
T	Filter
U	Finger Guard / TSL Fill Point
V	Pail Hook
W	Display
X	Gun Air Regulator
Y	Sprayer Air Pressure Regulator
Z	Air Pressure Gauge
	Model/Serial Tag (Not shown.)

Grounding



The equipment must be grounded to reduce the risk of static sparking and electric shock. An electric or static spark can cause fumes to ignite or explode. An improper ground can cause electric shock. A good ground provides an escape wire for the electric current.

This sprayer includes a ground wire with an appropriate ground contact.

The plug must be plugged into an outlet that is properly installed and grounded in accordance with all local codes and ordinances.

Do not modify the plug provided; if it does not fit the outlet, have the proper outlet installed by a qualified electrician.

Power Requirements

- 100-120V units require 100-120 VAC, 50/60 Hz, 15A, 1 phase.
- 230V units require 230 VAC, 50/60 HZ, 10A, 1 phase.

Extension Cords

Use an extension cord with an undamaged ground contact. If an extension cord is necessary, use a 3-wire, 12 AWG (2.5 mm²) minimum.

NOTE: Smaller gauge or longer extension cords may reduce sprayer performance.

Pails

Solvent and oil-based fluids: follow local code. Use only conductive metal pails, placed on a grounded surface such as concrete.

Do not place pail on a non-conductive surface such as paper or cardboard which interrupts grounding continuity.



Always ground a metal pail: connect a ground wire to the pail. Clamp one end to the pail and the other end to a true earth ground such as a water pipe.

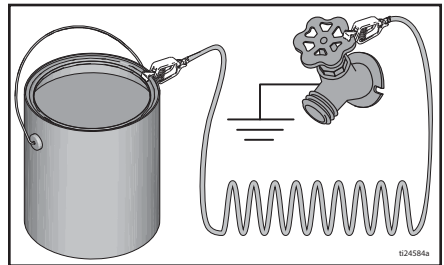

To maintain ground continuity when sprayer is flushed or pressure is relieved: hold metal part of spray gun firmly to the side of a grounded metal pail then trigger the gun.

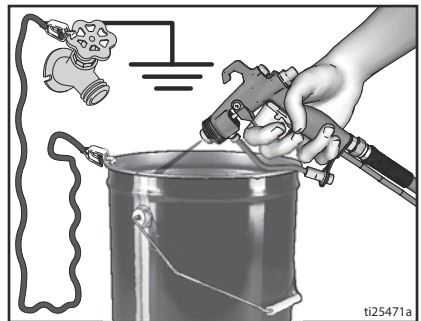

Pressure Relief Procedure

Pressure Relief Procedure



Follow the Pressure Relief Procedure whenever you see this symbol.



This equipment stays pressurized until pressure is manually relieved. To help prevent serious injury from pressurized fluid, such as skin injection, splashed fluid and moving parts, follow the **Pressure Relief Procedure** whenever sprayer is stopped and before sprayer is cleaned or checked, and before equipment is serviced.

1. Set SELECTOR switch to **OFF** position. Wait 7 seconds for power to dissipate.

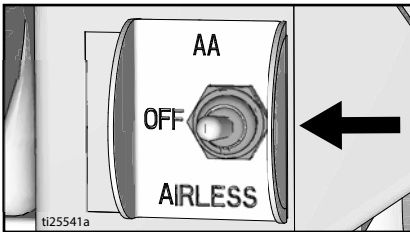

2. Engage trigger lock.

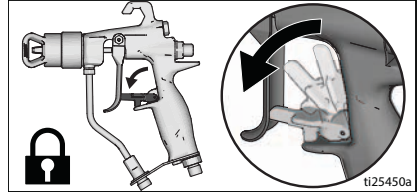

3. Turn pressure control to lowest setting. Disengage trigger lock.

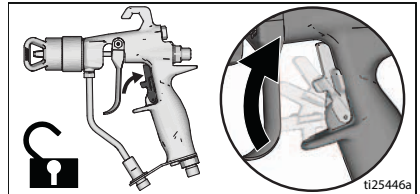

4. Hold a metal part of the gun firmly to a grounded metal pail. Trigger the gun to relieve pressure.

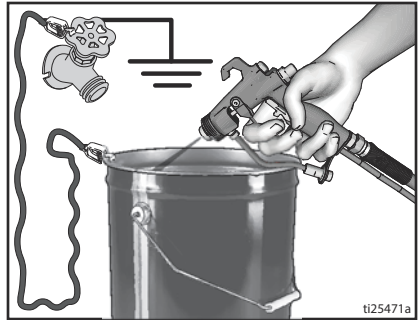

5. Engage trigger lock.

Pressure Relief Procedure

- Put drain tube in pail. Turn prime valve down. Leave prime valve in down (drain) position until you are ready to spray again.

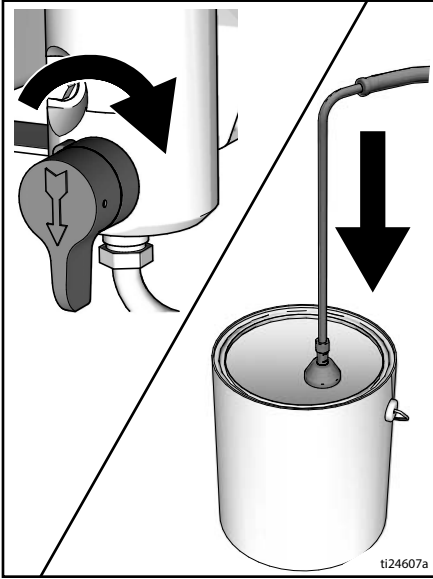

- If you suspect the spray tip or hose is clogged or that pressure has not been fully relieved:

- VERY SLOWLY loosen tip guard retaining nut or hose end coupling to relieve pressure gradually.
- Loosen nut or coupling completely.
- Clear hose or tip obstruction.

Trigger Lock

Always engage the trigger lock when sprayer is stopped to prevent the gun from being triggered accidentally by hand or if dropped or bumped.

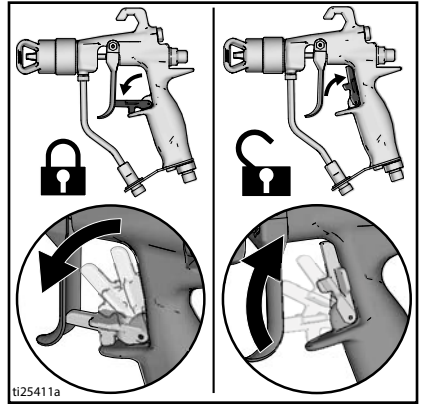

Setup

Setup



When unpacking sprayer for the first time or after long term storage perform setup procedure. When first setup is performed remove shipping plug from fluid outlet.

1. Connect Graco airless hose to fluid outlet. Use wrenches to tighten securely.

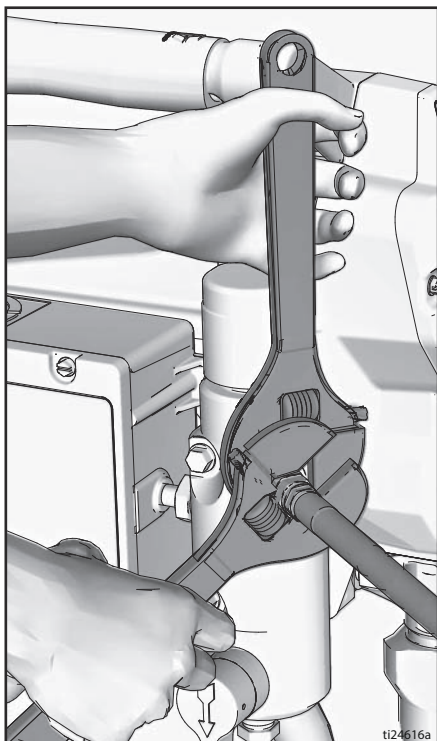

2. Connect other end of hose to gun.

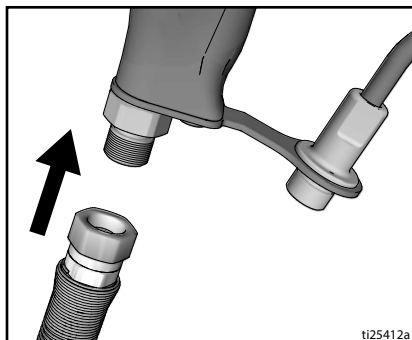

3. Use wrenches to tighten securely.
4. Engage trigger lock.

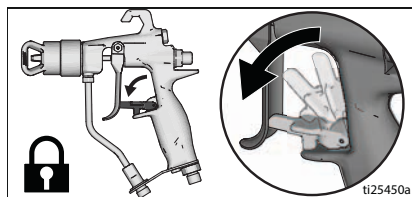

5. Remove tip guard/air cap.

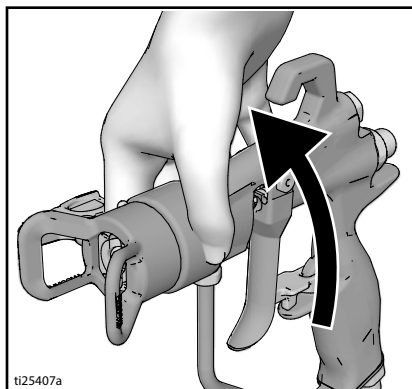

6. When unpacking sprayer for the first time remove packaging materials from inlet strainer. After long term storage check inlet strainer for clogs and debris.

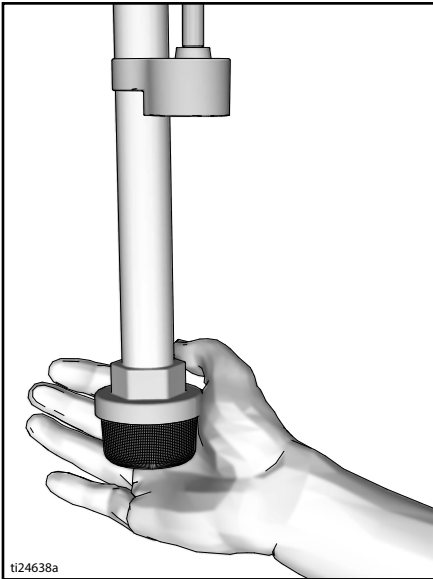

ti24638a

7. Fill throat packing nut with TSL to prevent premature packing wear. Do this daily or each time you spray.
 - a. Place the TSL bottle nozzle into the top center opening in the grill at the front of the sprayer.
 - b. Squeeze bottle to dispense enough TSL to fill the space between the pump rod and packing nut seal.

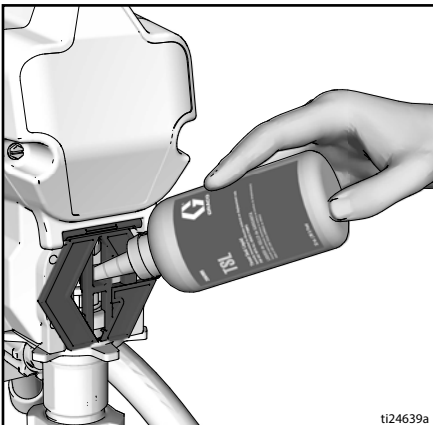

ti24639a

8. Make certain SELECTOR switch is OFF.

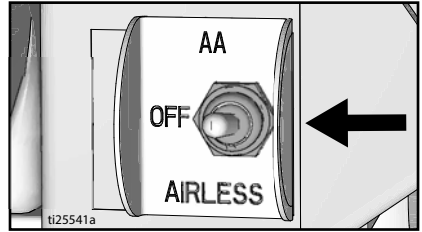

ti25541a

9. Plug power supply cord into a properly grounded electrical outlet.

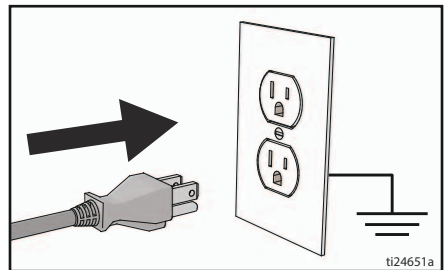

ti24651a

10. Turn prime valve down.

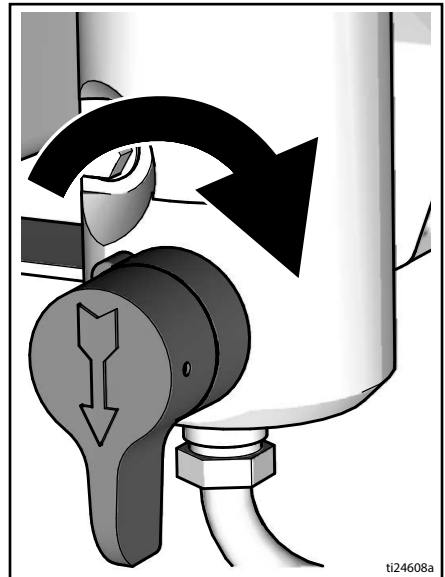

ti24608a

Setup

11. Place fluid intake with drain tube in grounded metal pail partially filled with flushing fluid. See **Grounding**, page 9.

NOTE: New sprayers are shipped with storage fluid that must be flushed out with mineral spirits prior to using the sprayer. Check flushing fluid for compatibility with material that is to be sprayed. A secondary flush with a compatible fluid may be necessary. Use water for latex paint or mineral spirits for oil-based paint.

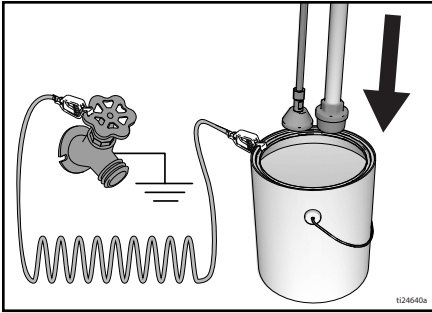

12. Turn pressure control to lowest setting.
13. Set **SELECTOR** switch to **AIRLESS** position.
14. Turn prime valve horizontal. Disengage trigger lock.
15. Increase pressure 1/2 turn to start motor.
16. Hold a metal part of the gun firmly to a grounded metal pail. Trigger gun and flush for one minute.
17. Set **SELECTOR** switch to **OFF** position.
18. Engage trigger lock.
19. After flushing storage fluid out of the sprayer empty pail. Replace fluid intake with drain tube in grounded metal pail partially filled with flushing fluid. Use water to flush water-based paint or mineral spirits to flush oil-based paint.

20. Set **SELECTOR** switch to **AIRLESS** position.
21. Turn prime valve horizontal. Disengage trigger lock.
22. Hold a metal part of the gun firmly to a grounded metal pail. Trigger gun and flush until clean.
23. Set **SELECTOR** switch to **OFF** position.
24. Engage trigger lock.
25. Sprayer is now ready to startup and spray in airless mode.
26. Attach air hose to sprayer air hose connection.

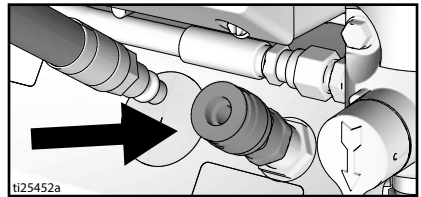

27. Cut air hose to length and couple to air connection on gun.

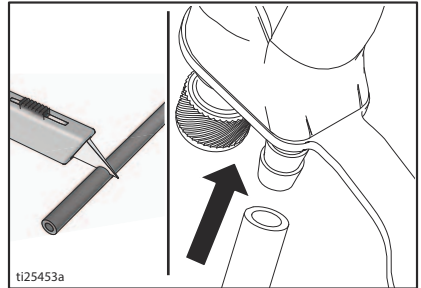

28. Sprayer is now ready to startup and spray in air-assisted (AA) mode.

Startup



1. Perform **Pressure Relief Procedure**, page 10.
2. Turn pressure control to lowest pressure.

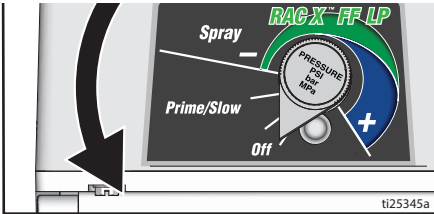

3. Set **SELECTOR** switch to **AIRLESS** position.

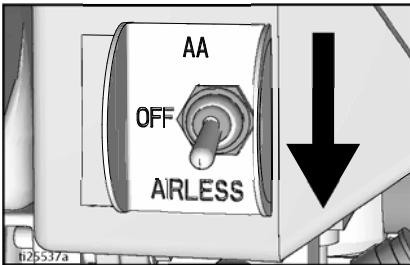

4. Place fluid intake in paint pail. Place drain tube in waste pail.
5. Increase pressure 1/2 turn to start motor. Allow paint to circulate through drain tube for 15 seconds.

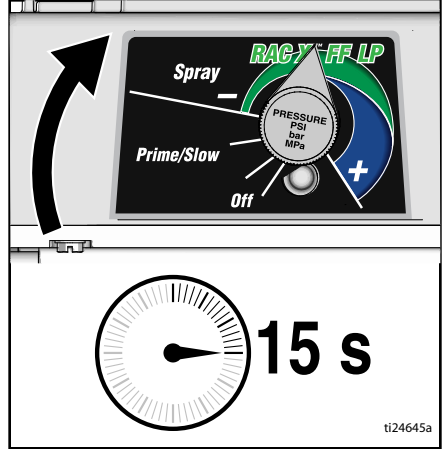

6. Turn prime valve horizontal. Disengage trigger lock.

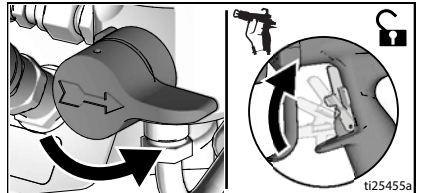

7. Hold gun against grounded metal waste pail. Trigger gun until paint appears.

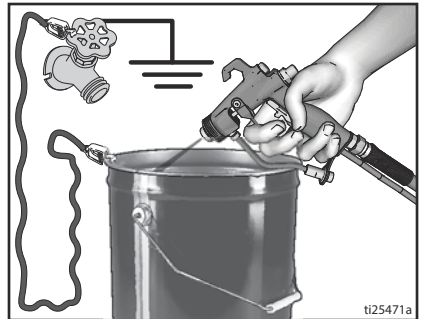

Startup

8. Move gun to paint pail and trigger for 20 seconds. Release trigger and allow sprayer to build pressure. Engage trigger lock.

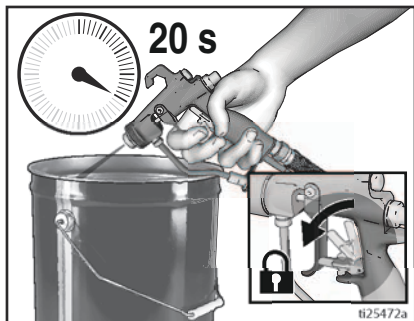

9. Inspect for leaks. If leaks occur, perform **Pressure Relief Procedure**, page 10, then tighten all fittings and repeat Startup procedure. If there are no leaks continue with the next step.
10. Screw tip assembly onto gun and tighten. See **Spray Tip Installation**, page 17. For gun assembly instructions, see separate gun manual.

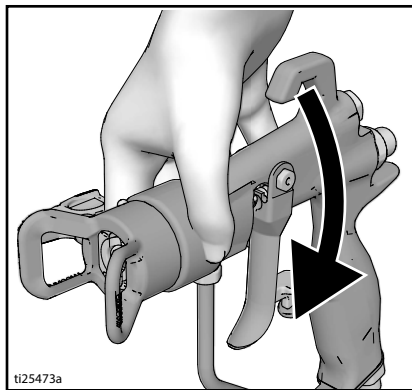

High-pressure spray is able to inject toxins into the body and cause serious bodily injury. Do not stop leaks with hand or rag.

Operation

Spray Tip Installation



1. Perform **Pressure Relief Procedure**, page 10.
2. Engage trigger lock.

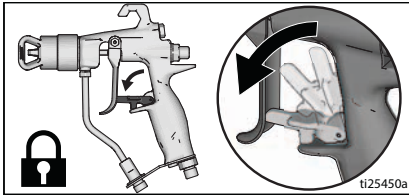

3. Insert seat (33a) into seat housing (35).
4. Insert seat housing (35) into air cap (6).
5. Insert seal (33b) over seat (33a). Use black seal for water-based materials and orange seal for solvent and oil-based materials.
6. Insert tip into slot (a) in air cap (6).

Tip Selection

Material	Oil Based	Water Based	Tip Size	Fluid Setting	Air setting
Stains/Varnish	✓	✓	.008/.010	500-700 psi (34-48 bar)	10-15 psi (0.7-1.0 bar)
Lacquers	✓	✓	.008/.010	700-1000 psi (48-69 bar)	10-15 psi (0.7-1.0 bar)
DTM		✓	.010/.012	900-1200 psi (62-83 bar)	15-20 psi (1.0-1.4 bar)
DTM (Alkyd)	✓		0.14/0.16	1800-2400 psi (124-165 bar)	20-25 psi (1.4-1.7 bar)
Enamels	✓	✓	0.14/0.16	1800-2400 psi (124-165 bar)	25-30 psi (1.7-2.1 bar)

NOTICE

If air cap is not fully installed on gun, fluid pressure can force paint into air line and damage sprayer.

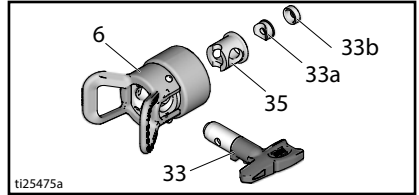

7. Install air cap over end of gun. Hand tighten.

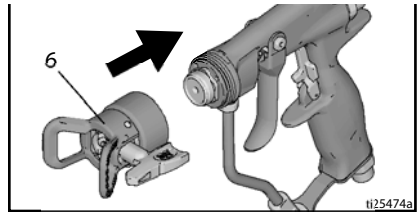

Operation

Spray

When a RAC X™ FF LP Fine Finish Low Pressure reversible spray tip is used, spraying pressure can be lowered. Spraying at a lower pressure results in less overspray and reduces spray tip wear. Adjust the sprayer pressure to minimize overspray.

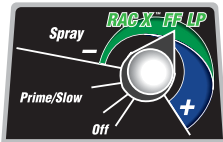

Atomized, evenly distributed fan pattern

Tails

Air-Assisted Spraying

NOTE: In high humidity conditions, moisture can accumulate in the air line. If this occurs, install an in-line desiccant filter (24U981 or 24U982) to prevent moisture from entering the gun.

1. Set SELECTOR switch to **AIRLESS** position.

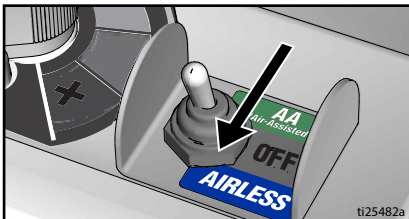

2. Open gun air regulator all the way.

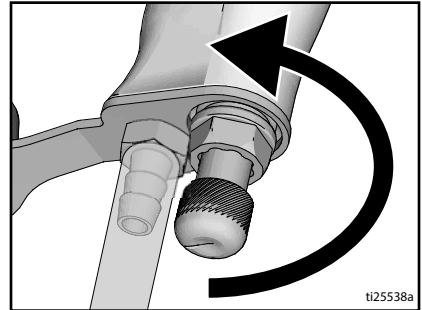

3. Prime pump, see **Startup**, page 15.
4. Set fluid pressure to highest setting.

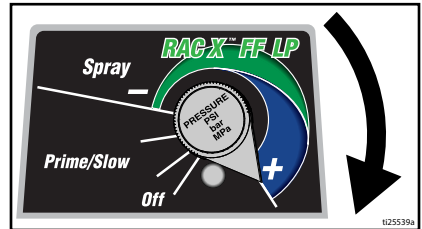

5. While spraying gun, decrease fluid pressure until tails appear in spray pattern.
6. Set SELECTOR switch to **AA** (Air-Assisted).



7. Trigger gun. While spraying, turn air regulator knob to increase pressure until tails disappear.

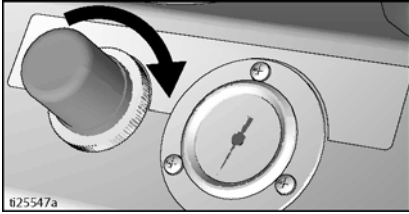

8. Use gun air regulator to fine tune spray pattern.

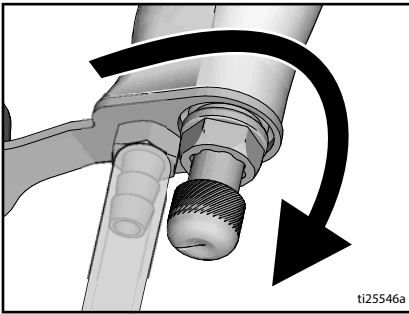

Airless Spraying

1. Set SELECTOR switch to **AIRLESS** position.

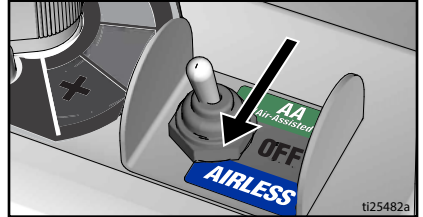

2. Prime pump, see **Startup**, page 15.
3. Start with pressure turned to the lowest setting. Spray test pattern. Gradually increase fluid pressure until you achieve a consistent spray pattern without heavy edges. Use a smaller tip size if pressure adjustment alone does not eliminate heavy edges.

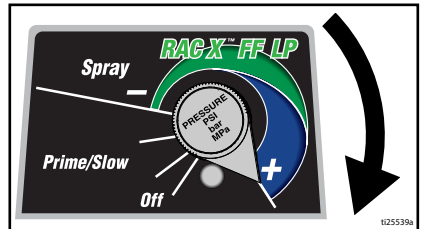

- Hold gun perpendicular and 10-12 inches from the surface. Overlap strokes by 50%.
- Move gun before triggering and release trigger before stopping.

Operation

Clear Tip Clog



1. Perform **Pressure Relief Procedure**, page 10.
2. Engage trigger lock.

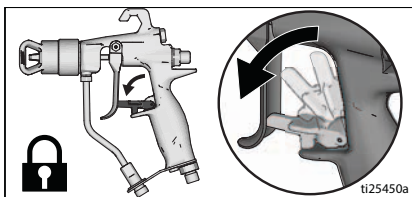

3. Engage trigger lock. Return spray tip to original position. Disengage trigger lock and continue spraying.
 - a. **Flat tip:** Remove and clean guard and tip
 - b. **RAC Tip:** Proceed to next step.
4. Rotate tip 180°.
5. Disengage trigger lock.
6. Trigger gun at waste area to clear clog.
7. Engage trigger lock.
8. Rotate tip back 180° to spray position.

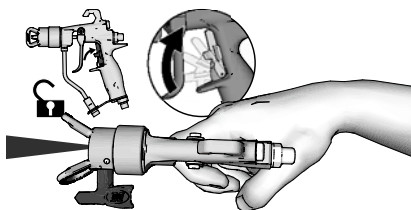
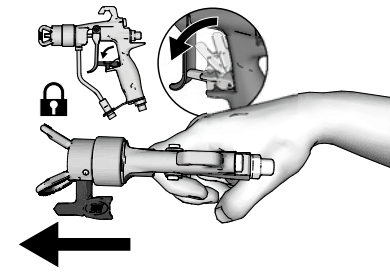
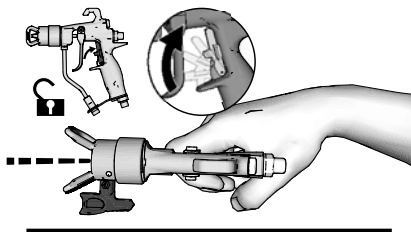
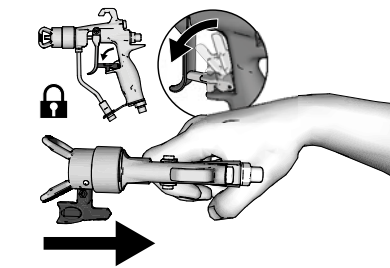

Digital Display

Most models are equipped with a digital display. This section explains how to use this feature.



Pressure Display

1. Perform **Pressure Relief Procedure**, page 10.
2. Plug sprayer into grounded outlet. Set **SELECTOR** switch to **AIRLESS** position.

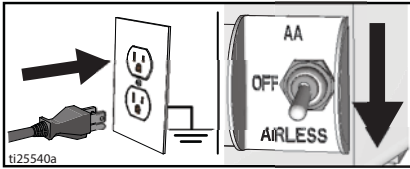

3. The pressure is displayed. Dashes indicate pressure is less than 200 psi (14 bar, 1.4 MPa).

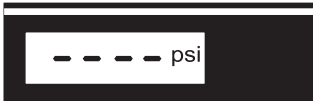

ti2786a

4. Press and hold display button to change pressure units (psi, bar, or MPa).



ti2888a

Stored Data Display



1. Set **SELECTOR** switch to **OFF** position.

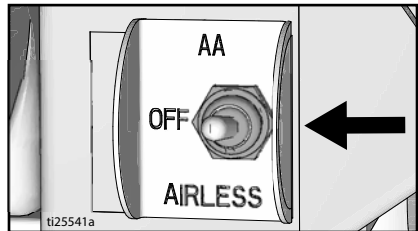

ti25541a

Operation

2. To enter Stored Data Mode, press and hold display button and set SELECTOR switch to **AIRLESS** position.

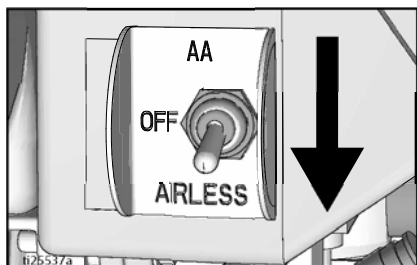

3. Sprayer model number is displayed followed by Data Point 1 which is the unit power ON time in hours.



4. Press display button again to display Data Point 2. Motor run time in hours is displayed.



5. Press display button again to display Data Point 3. This will be the last error code.



6. To erase last error code, press and hold display button.

7. Press display button again to display Data Point 4. The software revision is displayed.



8. Press display button again to return to Data Point 1.



9. Set SELECTOR switch to **OFF** position to exit Stored Data.

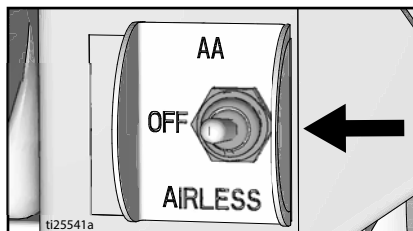

Cleanup



1. Perform **Pressure Relief Procedure**, page 10.
2. Remove tip guard and spray tip. For additional information, see separate gun manual.

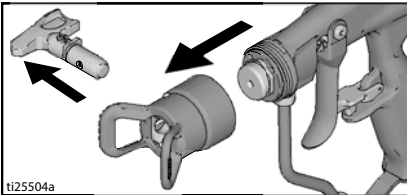

3. Remove fluid intake and drain tube from paint, wipe excess paint off outside.

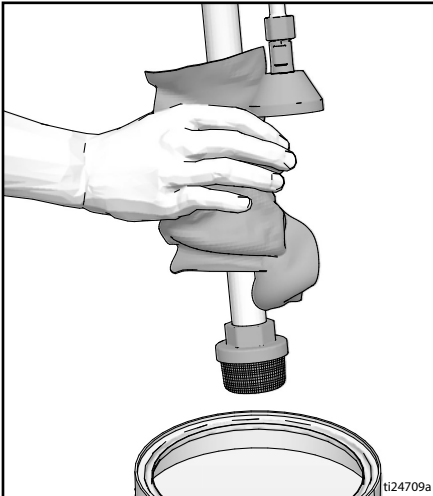

4. Place fluid intake in flushing fluid. Use water for water base paint and mineral spirits for oil-based paint. Place drain tube in waste pail.

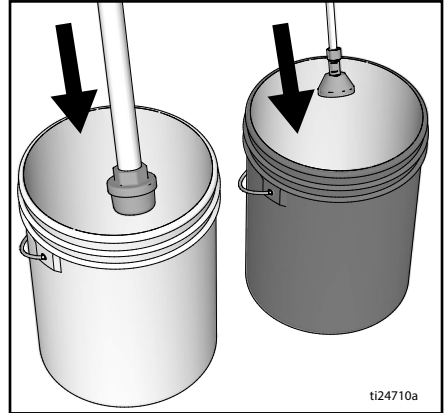

5. To flush drain tube turn prime valve down.
6. Increase pressure 1/2 turn to start motor. Hold gun against paint pail. Disengage trigger lock. Trigger gun and increase pressure until the pump runs steady and flushing fluid appears.

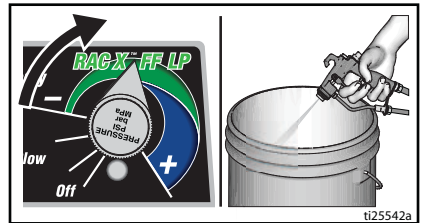

7. Stop triggering gun. Move gun to waste pail, hold gun against pail, trigger gun to thoroughly flush system.

Operation

8. While continuing to trigger gun, turn prime valve down. Then, release gun trigger. Allow flushing fluid to circulate until fluid comes out of drain tube clear.

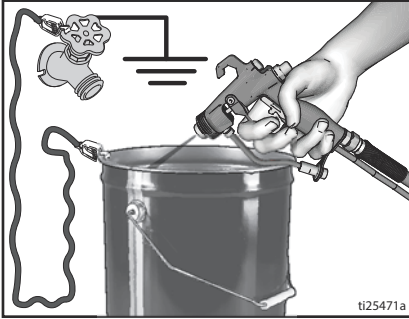

9. Raise fluid intake above flushing fluid.

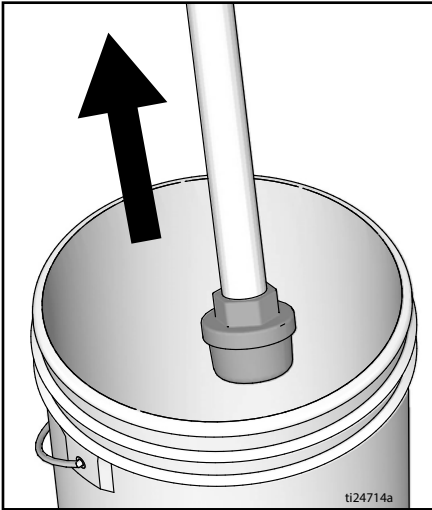

10. With prime valve horizontal. Trigger gun into flushing pail to purge fluid from hose.
11. Set SELECTOR switch to **AA** Air-Assisted position.

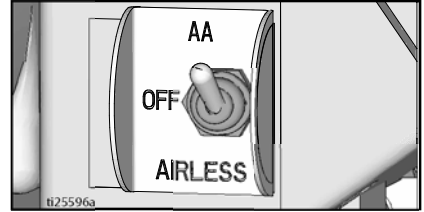

12. Trigger gun and slowly increase air pressure to blow material out of the gun air passages.



13. Engage trigger lock.

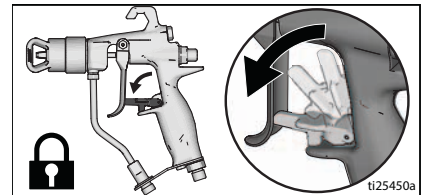

14. Turn pressure control knob to OFF and set SELECTOR switch to **OFF** position. Disconnect power to sprayer.

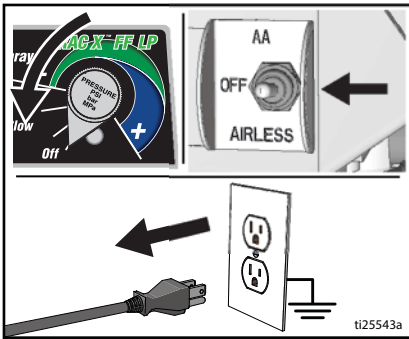

15. Remove filter from gun and sprayer if installed. Clean and inspect. Install filter. See separate gun manual.

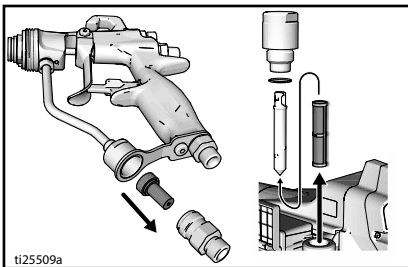

16. If flushing with water, flush again with mineral spirits or Pump Armor to leave a protective coating to prevent freezing or corrosion.

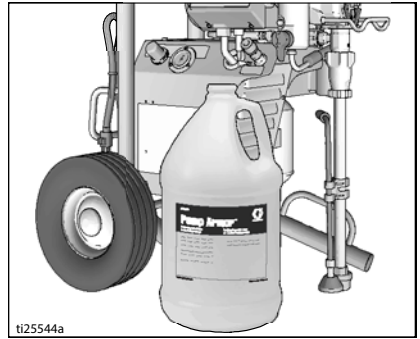

17. Wipe sprayer, hose and gun with a rag soaked in water or mineral spirits.

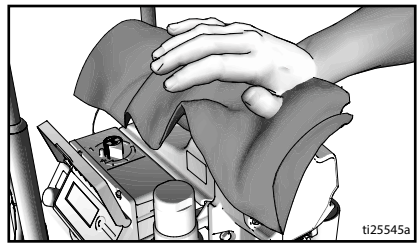

Maintenance

Routine maintenance is important to ensure proper operation of your sprayer. Maintenance includes performing routine actions which keep your sprayer in operation and prevents trouble in the future.



Activity	Interval
Inspect/clean sprayer filter, fluid inlet strainer, and gun filter.	Daily or each time you spray
Inspect motor shield vents for blockage.	Daily or each time you spray
Fill TSL by adding through TSL fill point.	Daily or each time you spray
Inspect motor brushes for wear. Brushes must be 1/2 in. (13mm) minimum length. NOTE: Brushes do not wear at the same rate on both sides of motor. Check both brushes.	Every 1000 gallons (3785 liters)
Check sprayer stall. With sprayer gun NOT triggered, sprayer motor should stall and not restart until gun is triggered again. If sprayer starts again with gun NOT triggered, inspect pump for internal/external leaks and check prime valve for leaks.	Every 1000 gallons (3785 liters)
Throat packing adjustment When pump packing begins to leak after extended use, tighten packing nut down until leakage stops or lessens. This allows approximately 100 gallons of additional operation before a repacking is required. Packing nut can be tightened without O-ring removal.	As necessary based on usage

Troubleshooting

Mechanical/Fluid Flow



1. Follow **Pressure Relief Procedure**, page 10, before checking or repairing.
2. Check all possible problems and causes before disassembling the unit.

Problem	What to Check If check is OK, go to next check	What to Do When check is not OK, refer to this column
<p>For units with display: E=0X is displayed.</p> <p>For units with no display: Control board status light is blinking or the light is off and there is power to the sprayer.</p>	Fault condition exists.	Determine fault correction from Electrical , page 30.
Pump output is low	Spray tip worn.	Follow Pressure Relief Procedure , page 10, then replace tip. See separate gun or tip manual.
	Spray tip clogged.	Relieve pressure. Check and clean spray tip.
	Paint supply.	Refill and reprime pump.
	Intake strainer clogged.	Remove and clean, then reinstall.
	Intake valve ball and piston ball are not seating properly.	Remove intake valve and clean. Check balls and seats for nicks; replace if necessary. See pump manual. Strain paint before using to remove particles that could clog pump.
	Fluid filter or tip filter is clogged or dirty.	Clean filter.
	Prime valve leaking.	Follow Pressure Relief Procedure , page 10, then repair prime valve.
	Verify pump does not continue to stroke when gun trigger is released. (Prime valve not leaking.)	Service pump. See pump manual.
Leaking around throat packing nut which may indicate worn or damaged packings.	Replace packings. See pump manual. Also check piston valve seat for hardened paint or nicks and replace if necessary. Tighten packing nut/wet-cup.	

Troubleshooting

Problem	What to Check If check is OK, go to next check	What to Do When check is not OK, refer to this column
Pump output is low	Pump rod damage.	Repair pump. See pump manual.
	Low stall pressure.	Turn pressure knob fully clockwise. Make sure pressure control knob is properly installed to allow full clockwise position. If problem persists, replace pressure transducer.
	Piston packings are worn or damaged.	Replace packings. See pump manual.
	O-ring in pump is worn or damaged.	Replace o-ring. See pump manual.
	Intake valve ball is packed with material.	Clean intake valve. See pump manual.
	Large pressure drop in hose with heavy materials.	Reduce overall length of hose.
	Check extension cord for correct size.	See Extension Cords , page 9.
	Loose motor brushes and terminals.	Tighten terminal screws. Replace brushes if leads are damaged.
	Worn motor brushes. (Brushes must be 1/2 in. [13mm] minimum length.)	Replace brushes.
	Broken and misaligned motor brush springs. Rolled portion of spring must rest squarely on top of brush.	Replace spring if broken. Realign spring with brush.
Motor runs but pump does not stroke	Connecting rod assembly damaged. See pump manual.	Replace connecting rod assembly. See pump manual.
	Gears or drive housing damaged.	Inspect drive housing assembly and gears for damage and replace if necessary.
Excessive paint leakage into throat packing nut	Throat packing nut is loose.	Remove throat packing nut spacer. Tighten throat packing nut just enough to stop leakage.
	Throat packings are worn or damaged.	Replace packings. See pump manual.
	Displacement rod is worn or damaged.	Replace rod. See pump manual.

Problem	What to Check If check is OK, go to next check	What to Do When check is not OK, refer to this column
Fluid is spitting from gun	Air in pump or hose.	Check and tighten all fluid connections. Cycle pump as slowly as possible during priming.
	Spray tip is partially clogged.	Clear tip. See Clear Tip Clog , page 20.
	Fluid supply is low or empty.	Refill fluid supply. Prime pump. See pump manual. Check fluid supply often to prevent running pump dry.
Pump is difficult to prime	Air in pump or hose.	Check and tighten all fluid connections. Cycle pump as slowly as possible during priming.
	Intake valve is leaking.	Clean intake valve. Be sure ball seat is not nicked or worn and that ball seats well. Reassemble valve.
	Pump packings are worn.	Replace pump packings. See pump manual.
	Paint is too thick.	Thin the paint according to supplier recommendations.
Sprayer operates for 5 to 10 minutes then stops	Pump packing nut too tight. When pump packing nut is too tight the packings on the pump rod restrict pump action and overloads the motor.	Loosen pump packing nut. Check for leaks around throat. If necessary, replace pump packings. See Pump manual.

Troubleshooting

Electrical

Symptom: Sprayer does not run, stops running, or will not shut off.



Perform **Pressure Relief Procedure**, page 10.

1. Plug sprayer into correct voltage, grounded outlet.
2. Set the SELECTOR switch to **OFF** wait 30 seconds and then set to **AIRLESS** (this ensures sprayer is in normal run mode).
3. Turn pressure control knob clockwise 1/2 turn.

4. View digital display or remove control box cover to view control board status light. To determine which code (or any other code besides voltage supply) refer to the control board status light. Set the SELECTOR switch to **OFF**, remove the control cover then set SELECTOR switch to **AIRLESS**. Observe the status light. Blinking LED total count equals the error code (for example: two blinks equals CODE 02).

Keep clear of electrical and moving parts during troubleshooting procedures. To avoid electrical shock hazards when covers are removed for troubleshooting, wait 7 seconds after disconnecting power cord for stored electricity to dissipate.				

Problem	What to Check	How to check
Sprayer does not run at all AND Display is blank OR Control board status light never lights	See flow chart, page 36.	
Sprayer does not shut off AND Display shows E=02 OR Control board status light blinks 2 times repeatedly	Control board.	Replace control board.

Problem	What to Check	How to check
<p>Sprayer does not run at all AND Display shows E=02 OR Control board status light blinks 2 times repeatedly</p>	<p>Check transducer or transducer connections</p>	<p>Make sure there is no pressure in the system (see Pressure Relief Procedure, page 10). Check fluid path for clogs, such as clogged filter.</p> <p>Use airless paint spray hose with no metal braid. A small hose or metal braid hose may result in high-pressure spikes.</p> <p>Set SELECTOR switch to OFF and disconnect power to sprayer.</p> <p>Check transducer and connections to control board.</p> <p>Disconnect transducer from control board socket. Check that transducer and control board contacts are clean and secure.</p> <p>Reconnect transducer to control board socket. Connect power, set SELECTOR switch to AIRLESS and control knob 1/2 turn clockwise. If sprayer does not run properly, set SELECTOR switch to OFF and go to next step.</p> <p>Install new transducer. Connect power, set SELECTOR switch to AIRLESS and control knob 1/2 turn clockwise. Replace control board if sprayer does not run properly.</p>
<p>Sprayer does not run at all AND Display shows E=03 OR Control board status light blinks 3 times repeatedly</p>	<p>Check transducer or transducer connections (control board is not detecting a pressure signal).</p>	<p>Set SELECTOR switch to OFF and disconnect power to sprayer.</p> <p>Check transducer and connections to control board.</p> <p>Disconnect transducer from control board socket. Check to see if transducer and control board contacts are clean and secure.</p> <p>Reconnect transducer to control board socket. Connect power, set SELECTOR switch to AIRLESS and control knob to 1/2 turn clockwise. If sprayer does not run, set SELECTOR switch to OFF and go to next step.</p> <p>Connect a confirmed working transducer to control board socket.</p> <p>Set SELECTOR switch to AIRLESS and control knob to 1/2 turn clockwise. If sprayer runs, install new transducer. Replace control board if sprayer does not run.</p>

Troubleshooting

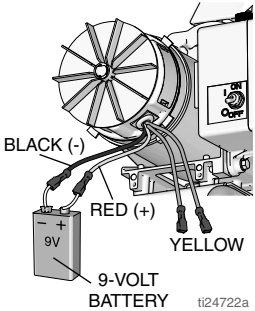
Problem	What to Check	How to check
Sprayer does not run at all AND Display shows E=04 OR Control board status light blinks 4 times repeatedly	Check voltage supply to the sprayer (control board is detecting a multiple voltage surges).	Set SELECTOR switch to OFF and disconnect power to sprayer. Locate a good voltage supply to prevent damage to electronics.
Sprayer does not run at all AND Display shows E=05 OR Control board status light blinks 5 times repeatedly	Control is commanding motor to run but motor shaft does not rotate. Possibly locked rotor condition, an open connection exists between motor and control, there is a problem with motor or control board, or motor amp draw is excessive.	<ol style="list-style-type: none"> 1. Remove pump and try to run sprayer. If motor runs, check for locked or frozen pump or drive train. If sprayer does not run, continue to step 2. 2. Set SELECTOR switch to OFF and disconnect power to sprayer. 3. Disconnect motor connector(s) from control board socket(s). Check that motor connector and control board contacts are clean and secure. If contacts are clean and secure, continue to step 4. 4. Connect a DC voltmeter across the two motor wires – red & black spin the motor fan and check for a voltage to register on the meter. If voltage is not present, check brushes. If OK, replace motor. If voltage is present, go to step 5. 5. Perform a spin test by connecting a 9 –12 Volt battery to the motor leads. Motor leads may vary in style and size. Locate the two wires going to the carbon brushes normally Red and Black. Motor should spin when battery is connected to the motor leads. <div style="text-align: right; margin-top: 20px;">  <p>BLACK (-) RED (+) YELLOW 9-VOLT BATTERY ti24722a</p> </div>

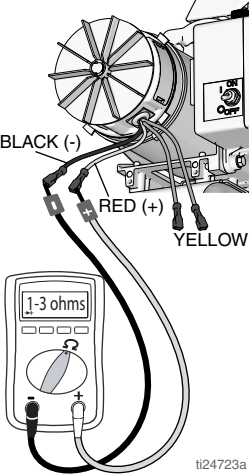
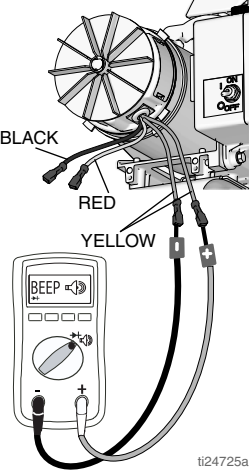
Problem	What to Check	How to check
		<p data-bbox="713 180 1025 315">6. Connect the Red and Black leads from the motor to an Ohm meter. Rotate the motor while checking for opens. If an open is found replace the motor.</p>  <p data-bbox="944 808 998 824">ti24723a</p> <p data-bbox="713 834 1025 1016">7. Check motor thermal protection. Motor should be at ambient temperature for this test. Connect the yellow leads from the motor to an Ohm meter. Meter should indicate continuity or Ohms depending on the motor type.</p>  <p data-bbox="944 1511 998 1528">ti24725a</p>

Troubleshooting

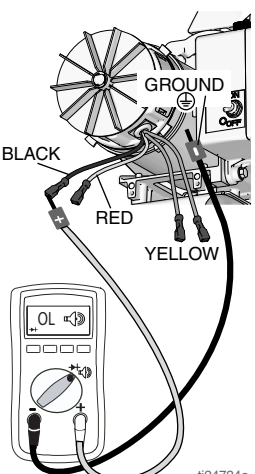
Problem	What to Check	How to check
		<p>8. Use an Ohm meter to check motor for shorts. Connect (-) meter lead to motor case. Move the (+) meter lead to each motor wire. Meter should read open on all wires.</p>  <p style="text-align: right; font-size: small;">ti24724a</p>
<p>Sprayer does not run at all AND Display shows E=06 OR Control board status light blinks 6 times repeatedly</p>	<p>Motor is hot or there is a fault in the motor thermal device.</p>	<p>Allow sprayer to cool. If sprayer runs when cool, correct cause of overheating. Keep sprayer in cooler location with good ventilation. Make sure motor air intake is not blocked. If sprayer still does not run, replace motor.</p>
<p>Sprayer does not run at all AND Display shows E=08 OR Control board status light blinks 8 times repeatedly</p>	<p>Check voltage supply to the sprayer (incoming voltage too low for sprayer operation).</p>	<p>Set SELECTOR switch to OFF and disconnect power to the sprayer.</p>

Problem	What to Check	How to check
Basic electrical problems	Motor leads are securely fastened and properly mated	Replace loose terminals; crimp to leads. Be sure terminal are firmly connected. Clean circuit board terminals. Securely reconnect leads.
	For loose motor brush lead connections and terminals.	Tighten terminal screws. Replace brushes if leads are damaged.
	Brushes must be 1/2 in. [13mm] minimum. NOTE: Brushes do not wear at the same rate on both sides of motor. Check both brushes.	Replace brushes.
	Broken or misaligned motor brush springs. Rolled portion of spring must rest squarely on top of brush.	Replace spring if broken. Realign spring with brush.
	Motor brushes may be binding in brush holders.	Clean brush holders. Remove carbon with small cleaning brush. Align brush leads with slot in brush holder to assure free vertical brush movement.
	Motor armature commutator for burn spots, gouges or extreme roughness.	Remove motor and have motor shop resurface commutator if possible.

Troubleshooting

Sprayer Will Not Run

(See following page for steps)

Sprayer Will Not Run

(see following pages for steps)

Remove Control box cover. Turn sprayer ON. Observe control board status light on control board (see page 27).	
No Light	
Once	Normal Operation
Light on continuously	Control board Commanding motor to run
Flashing	See Code section for further troubleshooting

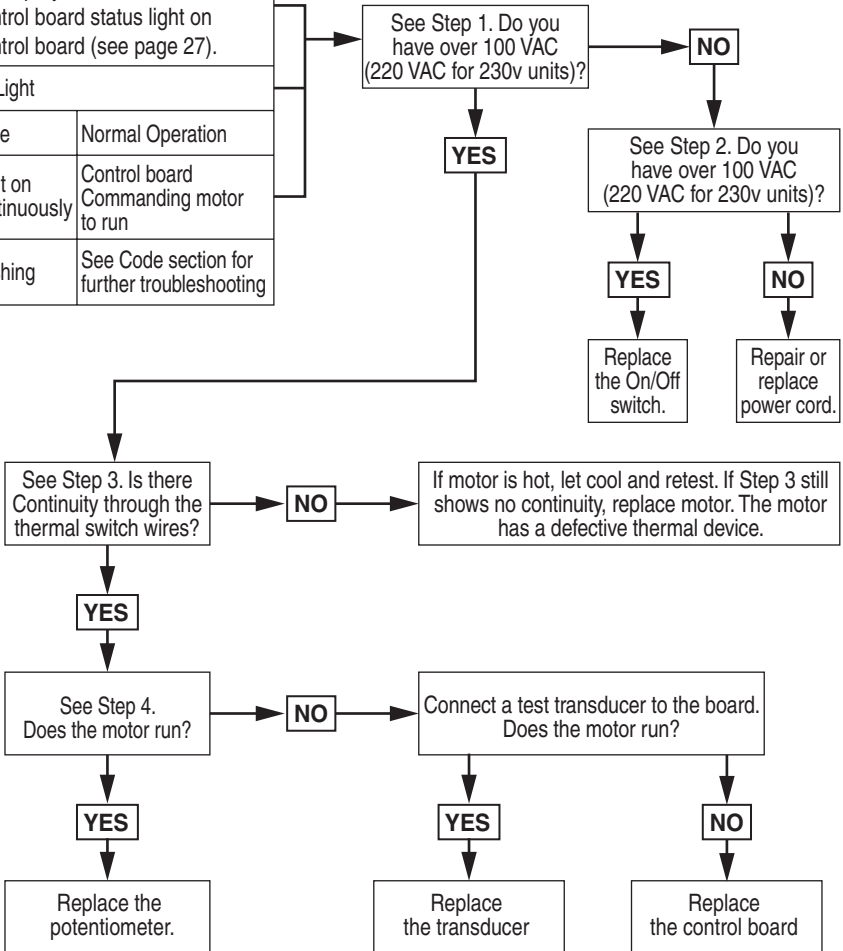

ti24726a

Step 1:

Plug Power cord in and turn switch ON. Connect probes to L and N on control board. Turn meter to AC Volts.

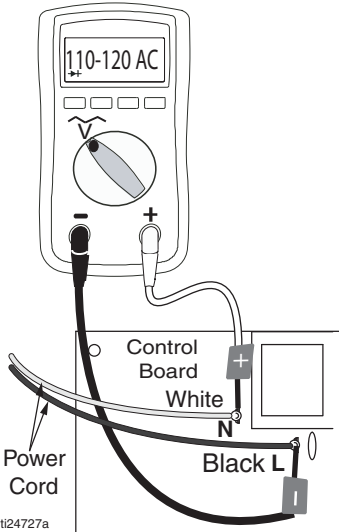

Step 2:

Plug power cord in and turn switch ON. Connect Probes to ON/OFF switch. Turn meter to AC Volts.

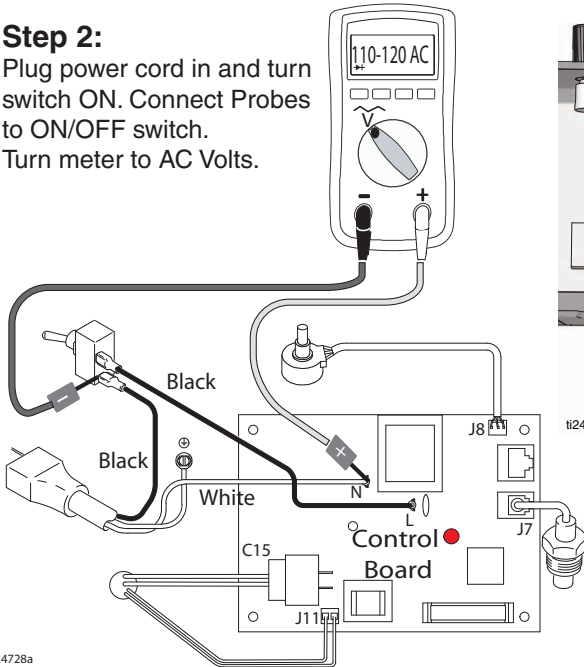

Step 3:

Check motor thermal switch. Unplug yellow wires. Meter should read continuity.

NOTE: Motor should be cool during reading.

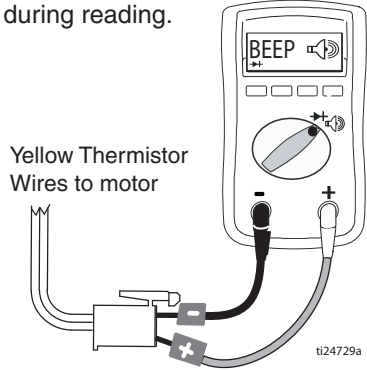

Step 4:

Disconnect potentiometer. Plug power cord in and turn switch ON.

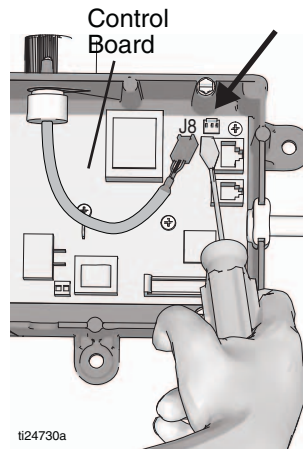

Troubleshooting

Sprayer Will Not Shut Off

1. Perform **Pressure Relief Procedure**, page 10. Leave prime valve open
2. Remove control box cover so the control board status light can be viewed if available.

Troubleshooting Procedure

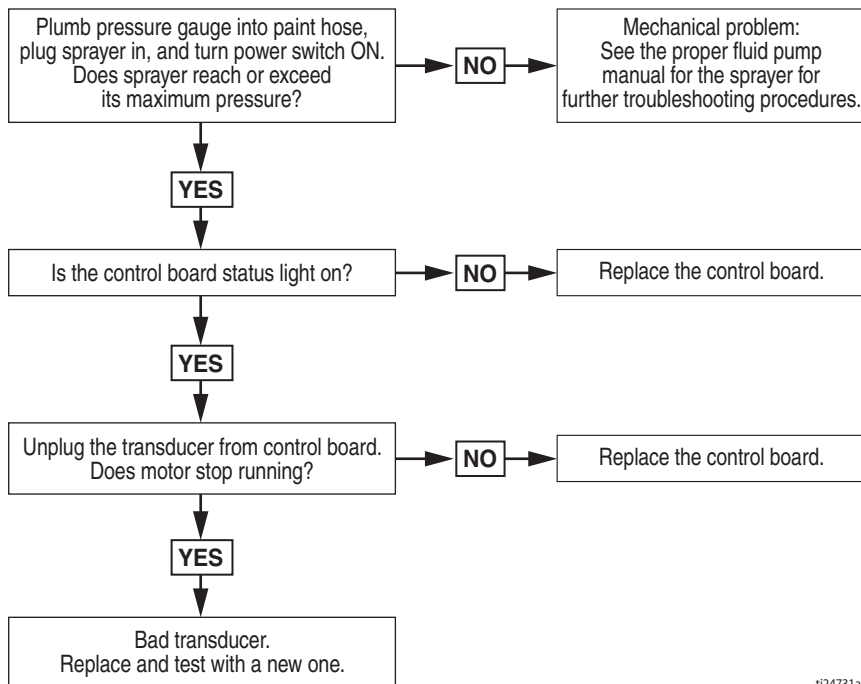

Troubleshooting Procedure



ti24731a

Sprayer



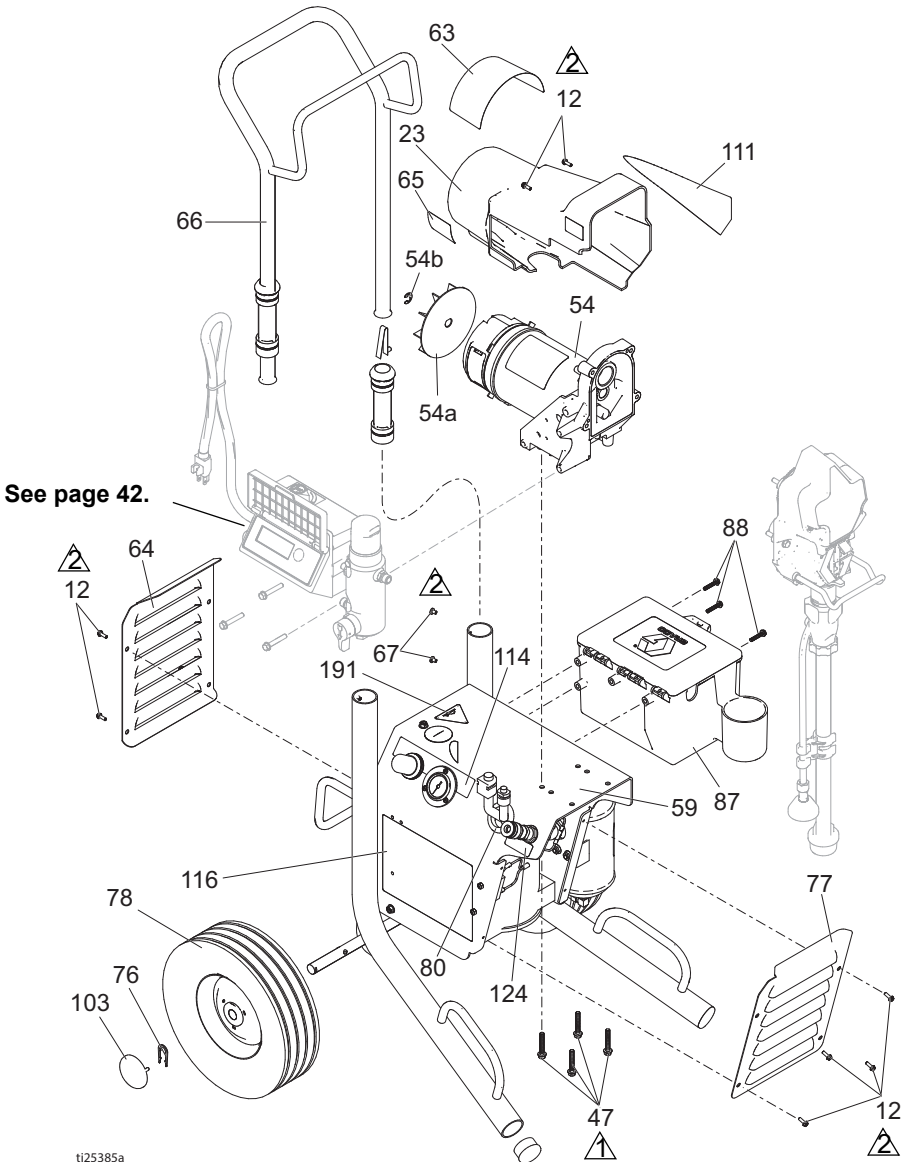

See page 44 for Compressor parts.

Ref.	Torque
 1	140-160 in-lb (15.8 - 18.1 N•m)
 2	30-35 in-lb (3.4 - 4.0 N•m)



t125385a

Sprayer

Ref.	Torque
	140-160 in-lb (15.8 - 18.1 N•m)
	30-35 in-lb (3.4 - 4.0 N•m)
	Hammer tight
	25-30 ft-lb (33.9 - 40.7 N•m)

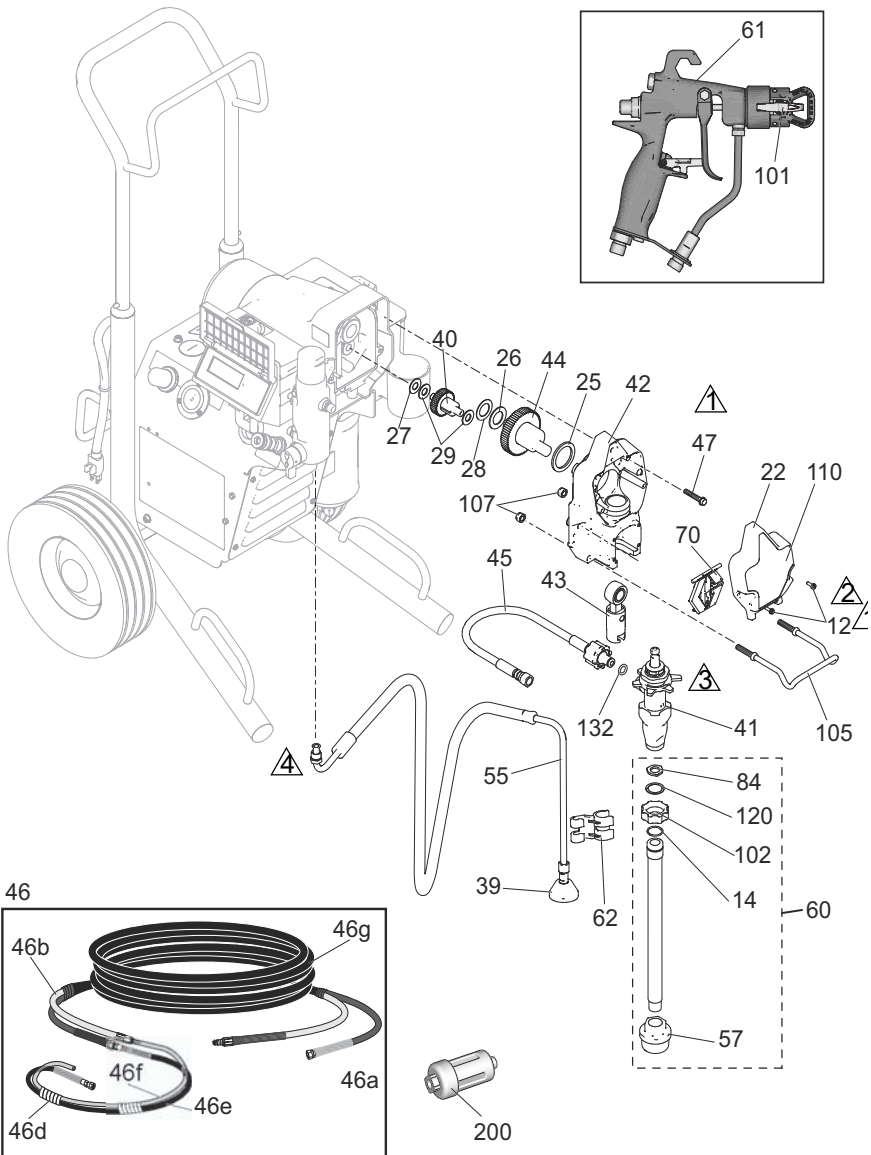

ti25384a

Sprayers Parts List

Ref.	Part	Description	Qty.	Ref.	Part	Description	Qty.
12	117501	SCREW, mach, slot hex wash hd	12	59	24U249	FRAME, cart, hi, AA	1
14	103413	PACKING, o-ring	1	60	17C992	TUBE, suction <i>includes 14, 57, 84, 102, 120</i>	1
22	17C539	COVER, front, painted	1	61		GUN, assy, AA G40	1
23	15B465	SHIELD, motor, painted	1		262929	Models 17C417, 17C321	1
25	180131	BEARING, thrust	1		262932	Models 17C418, 17C421, 17C320	1
26	107434	BEARING, thrust	1	62	276888	CLIP, drain line	1
27	116073	WASHER, thrust	1	63▲		LABEL, warning, fire/explosion, skin	1
28	116074	WASHER, thrust	1		15B516	Model 17C417	1
29	116079	BEARING, thrust	2		15H087	Model 17C321	1
39	241920	DEFLECTOR, threaded	1		16G596	Models 17C418, 17C421, 17C320	1
40	249194	GEAR, reducer	1	64	15K053	PLATE, rear, painted	1
41		PUMP, displacement, PC	1	65▲		LABEL, warning	1
	17C487	North America			16G596	Models 17C320, 17C417, 17C421	1
	17C488	Asia/ANZ/Japan			195793	Model 17C417	1
	17C489	Europe			195792	Model 17C321	1
42	24W817	HOUSING, drive, PC <i>includes 12, 70</i>	1	66	287489	HANDLE, assy, hi cart	1
43	24W640	ROD, connecting, PC	1	67	109032	SCREW, mach, prh	4
44	24X020	KIT, repair, crankshaft, <i>includes 25</i>	1	70	17C483	COVER, pump rod	1
45	24W830	KIT, hose, cpld, PC, <i>includes 132</i>	1	76	15B999	CLIP, retaining	2
46	24U578	3300 psi hose set, 25 ft. (7.6m) Models 17C418, 17C421, 17C320 <i>includes 46a, 46b, 46d, 46e, 46f, 46g</i>	1	77	15K052	PLATE, front, painted	1
46a	278763	HOSE, cpld, 1/4 x 25 ft.	1	78	106062	WHEEL, semi pneumatic	2
46b	16X398	HOSE, air, 25 ft. (7.6m)	1	80	120685	GROMMET	1
46d	15X843	SLEEVE, wrap	3	84	115099	WASHER, garden hose	1
46e	278750	HOSE, Nylon, fluid, 6 ft. (1.8m)	1	87	287253	TOOL BOX, <i>includes 88</i>	1
46f	278751	HOSE, whip, air	1	88	118852	SCREW, thd forming, hex washer hd	3
46g	24U577	COVER, flex	1	101		TIP, spray, latex RAC X	1
46	24U579	3300 psi hose set, 50 ft. (15.2m) Models 17C417, 17C321 <i>includes 46a, 46b, 46d, 46e, 46f, 46g</i>	1		LTX517	Models 17C321, 17C417	1
46a	278764	HOSE, cpld, 1/4 x 50 ft.	1		PAA517	All other models	1
46b	16X433	HOSE, air, 50 ft.	1	102	15E813	NUT, jam	1
46d	15X843	SLEEVE, wrap, spiral	3	103	104811	CAP, hub	2
46e	278750	HOSE, Nylon, fluid, 6 ft. (1.8m)	1	105	17C990	HOOK, pail	1
46f	278751	HOSE, whip, air, 50 ft.	1	107	111040	NUT, lock, insert, nylock, 5/16	2
46g	16X453	COVER, flex, 60 ft.	1	110	17C850	LABEL, brand, front	1
47	117493	SCREW, mach, hex washer HD	8	111	17C851	LABEL, brand, side	1
54*		MOTOR, 395 <i>includes 54a, 54b</i>	1	114	15K468	LABEL, AA, regulator/gauge	1
	288859	Models 17C417, 17C320	1	116	15K465	LABEL (Models 17C417, 17C321)	1
	287060	Models 17C418, 17C421, 17C321	1	120	15B652	WASHER, suction	1
54a	248189	FAN, motor	1	124	290228	LABEL, caution	1
54b	115477	SCREW, mach, Torx, painted	1	132	16H137	PACKING, o-ring	1
55	287952	HOSE, drain, Ultra hi-boy, <i>includes 39</i>	1	145	111909	PLUG, button	1
57	246385	STRAINER, 7/8-14 unf	1	171▲	16D646	LABEL, warning	1
				200		KIT, in-line desiccant	1
					24U981	5 pack	
					24U982	25 pack	
					206994	FLUID, TSL, 8 oz	1
				*	287735	KIT, repair, brush	1

▲Replacement Danger and Warning labels, tags, and cards are available at no cost.

Control and Filter

Control and Filter

Ref.	Torque
	140-160 in-lb (15.8 - 18.1 N•m)
	30-35 in-lb (3.4 - 4.0 N•m)
	20-25 in-lb (2.3 - 2.8 N•m)
	37-43 ft-lb (50.2 - 58.3 N•m)
	130-150 in-lb (14.7 - 16.9 N•m)

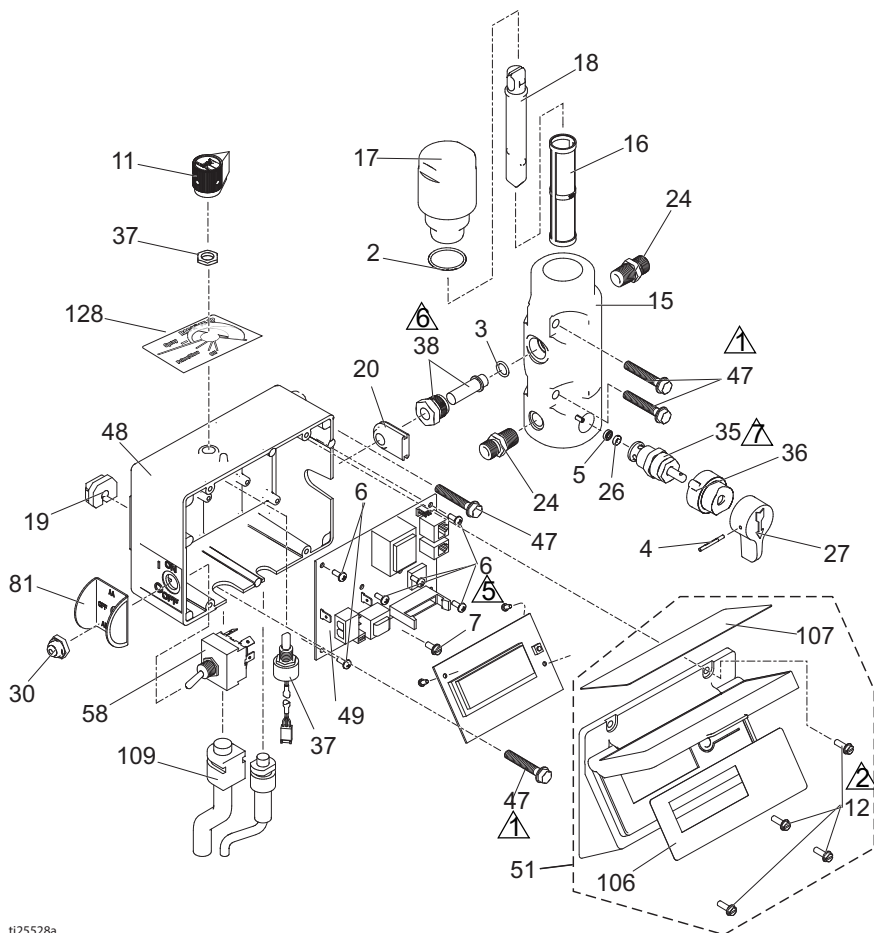



ti25528a

Control and Filter Parts List

Ref.	Part	Description	Qty.	Ref.	Part	Description	Qty.
2	117828	PACKING, o-ring	1		15M176	Model 17C418,	1
3	111457	PACKING, o-ring	1			17C421, 17C320,	
4	111600	PIN, grooved	1			17C321	
5	277364	GASKET, seat, valve	1	49		CONTROL BOARD	
6	115494	SCREW, mach, phillips pan hd	9		288840	Model 17C417	1
7	115498	SCREW, slot, hex, wash hd	1		288842	Model 17C418,	1
11	116167	KNOB, potentiometer	1			17C421, 17C321	
12	117501	SCREW, mach, hex washer hd	4		288843	Model 17C320	1
15	15G455	MANIFOLD, fluid	1	51	24B026	KIT, display, st <i>includes</i> <i>106, 107</i>	1
16		FILTER, fluid	1	58		SWITCH, toggle	1
	246425	30 mesh			120544	Model 17C417	
	246384	60 mesh			120844	All other models	
	246382	100 mesh, original		81	15J988	PLATE, switch	1
	246383	200 mesh		106	15B461	LABEL, smart control display	1
17	287902	KIT, repair, filter cap <i>includes 18</i>	1	107	15K400	LABEL, digital tracking system	1
18	15B071	INSERT, filter	1	109		CORD, power	
19	15B118	BUSHING, control box	1		15D029	Model 17C417	1
20	15B120	GROMMET, transducer	1		15B469	Model 17C320	1
24	162453	NIPPLE, (1/4 npsm x 1/4 npt)	2		15B470	Model 17C418	1
26	15E022	SEAT, valve	1		15B471	Models 17C421, 17C321	1
27	187625	HANDLE, valve, drain	1	115	15K470	LABEL, switch, AA, 395	1
30	195428	BOOT, toggle	1	125	242001	CORD SET, adapter, Europe (Models 17C421, 17C321)	1
35	239914	VALVE, drain <i>includes</i> <i>5, 26</i>	1	126	242005	CORD SET, adapter, Australia (Models 17C321, 17C421)	1
36	224807	BASE, valve	1	127	287121	CORD SET, Italy, Den- mark, Switzerland (Model 17C421)	1
37	256219	POTENTIOMETER, adj, pressure with nut	1	128	17P737	LABEL, pressure, adjustment	1
38	243222	TRANSDUCER, pres- sure control, <i>includes 3</i>	1			KIT, ProGuard+, (not shown)	1
47	117493	SCREW, mach, hex washer hd	4		24W090	CEE 7/7	
48		CONTROL BOX, machined			24W755	Multicord, IEC-320	
	15J469	Model 17C417	1				

Compressor

Compressor

Ref.	Torque
 60-85 in-lb (6.8 - 9.6 N•m)	
 95-100 in-lb (10.7 - 11.3N•m)	

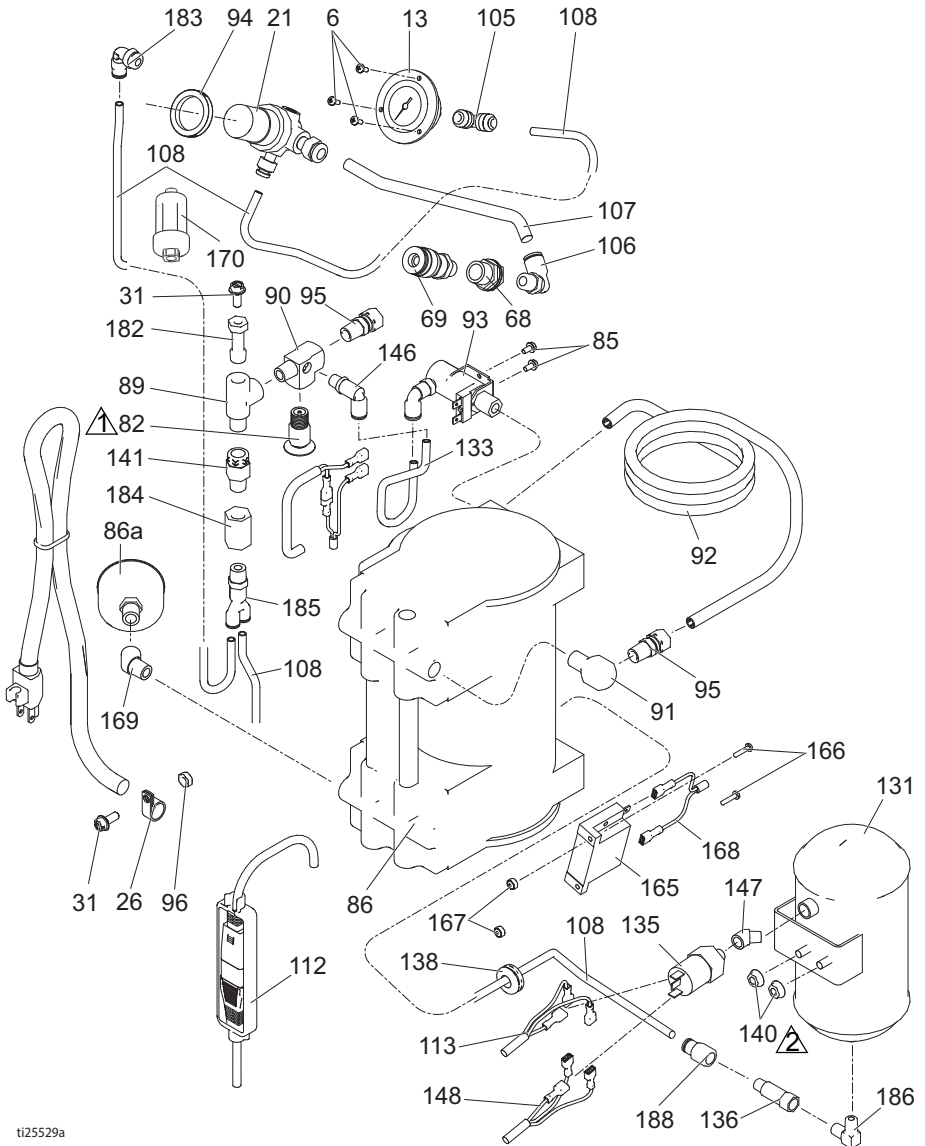

ti25529a

Compressor Parts List

Ref.	Part	Description	Qty.	Ref.	Part	Description	Qty.
6	115494	SCREW, mach, Phillips	3	108	15B822	TUBE, air	2
13	120643	GAUGE, pressure, panel mount, 1.5	1	112	195551	RETAINER, plug, adapter	1
21	127330	REGULATOR, air, 1/4 in. npt	1	113	16X530	CORD, pwr, comp. female end	1
26		CLAMP, wire	1	131	16X915	TANK, painted	1
	113491	Model 17C417		133	16X477	HOSE, air	1
	120143	All other models		135	127343	SWITCH, pressure	1
31	117633	SCREW, slot hex wash hd	6	136	127339	VALVE, check, 1/8 in. mnpt x fnpt	1
68	104641	FITTING, bulkhead	1	138	801012	GROMMET	1
69	120963	COUPLE, quick, disconnect	1	140	115942	NUT, hex, flange head	2
82	122703	VALVE, pressure, relief	1	141	127340	VALVE, check, 1/4 in. mnpt x fnpt	1
85	109575	SCREW, threadforming, hexhead	2	146	597151	FITTING, elbow	3
86		AIR COMPRESSOR (includes 86a)		147	113630	ELBOW, street 45 degree 1/8 npt	1
	288720	Models 17C417, 17C320	1	148	16X827	CORD, compress/control board	1
	288722	Models 17C418, 17C421, 17C321	1	150	16X906	LABEL, brand, smart-comp	1
86a	288724	KIT, compressor, filter	1	165		TIMER, solid state	
89	106228	FITTING, brass, elbow	1		16Y436	Models 17C417, 17C320	1
90	16Y589	FITTING, tee	1		16Y437	Models 17C418, 17C421, 17C321	1
91	187357	ELBOW, street	1	166	125483	SCREW, mach, pnh, sems, phillips	2
92	16X397	TUBE, heat exchange, 395/595	1	167	C19862	NUT, lock, hex	2
93		SOLENOID, 2 way, norm open	1	168	16Y442	CORD, compressor to timer	1
	16X399	Model 17C417, 17C320	1	169	113444	FITTING, elbow, street	1
	16X526	Model 17C418, 17C421, 17C321	1	170	127465	FILTER, in-line, desiccant	1
94	15K040	NUT, regulator, metal	1	182	17B227	FITTING, stand-off	1
95	120732	FITTING, compression, male connect	2	183	114109	FITTING, elbow, male	1
96	100015	NUT, hex mscr	1	184	113093	CONNECTOR, pipe	1
105	120653	FITTING, push to conn	1	185	127716	CONNECTOR, Y, male	1
106	120753	FITTING, push to connect elbow	1	186	110287	RETAINING, ring	1
107	15K391	TUBE, air	1	188	114320	FITTING, connector, female	1

Wiring Diagrams

Wiring Diagrams

120V, US/110V, UK

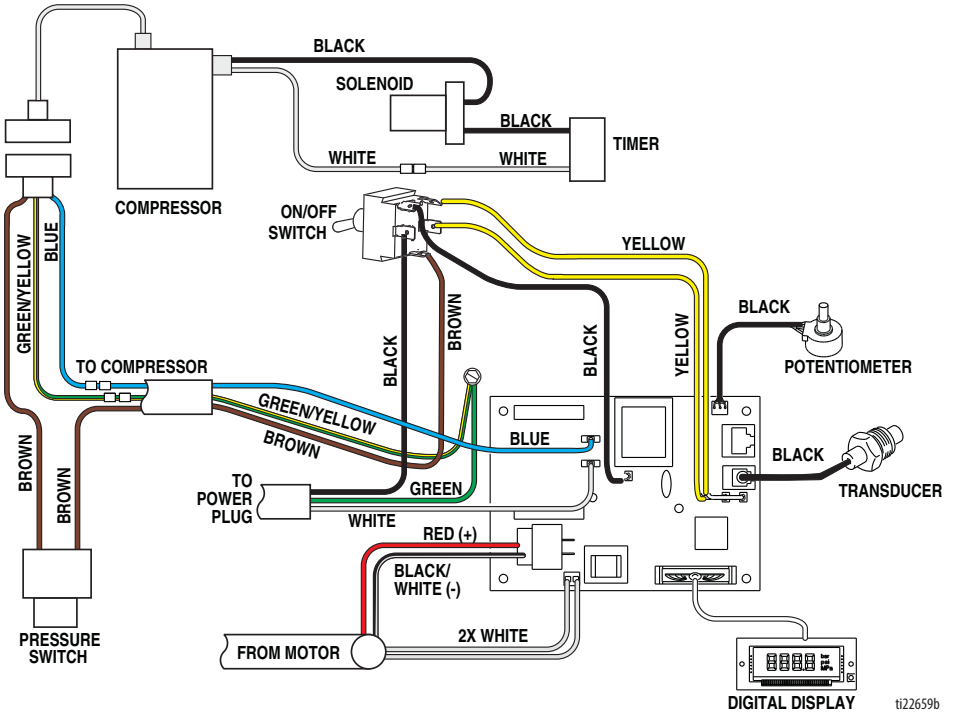

t122659b

230V

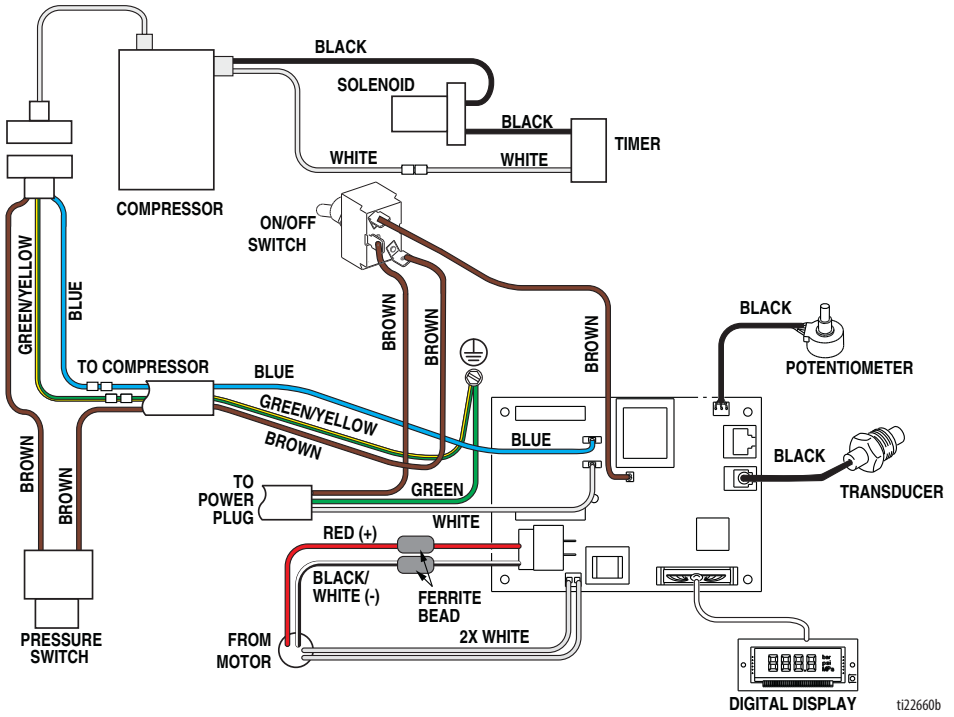

t122660b

Technical Specifications

Technical Specifications

FinishPro II 395 PC		
	US	Metric
Sprayer		
Power requirements	★100/120V AC, 50/60 Hz, 15A, 1Ø	◆ 230V AC, 50/60 Hz, 10A, 1Ø
Generator Minimum	4000 W	
Max tip size		
US★ / UK★	0.021	0.021
Europe◆ / Asia/Australia◆	0.023	0.023
Max material output gpm (lpm)		
US ★ / UK★	.47 gpm	1.8 lpm
Europe◆ / Asia/Australia◆	.54 gpm	2.0 lpm
Maximum material pressure - Airless		
US ★	3300 psi	227 bar
UK★	2800 psi	193 bar
Europe◆ / Asia/Australia◆	3300 psi	227 bar
Maximum material pressure - AA		
US ★ / UK★	2800 psi	193 bar
Europe◆ / Asia/Australia◆	3300 psi	227 bar
Atomizing air output		
US★ / UK★	3.2 cfm	3.2 cfm
Europe / Asia/Australia	2.9 cfm	2.9 cfm
Air pressure	35 psi	2.4 bar
Dimensions		
Length	32.5 in.	82.5 cm
Width	21 in.	53.3 cm
Height	40.5 in.	102.8 cm
Weight (bare)	110 lb	49.9 kg
Noise** (dBa) @ 70 psi (0.48 MPa, 4.8 bar)		
Sound pressure	79 dBA	
Sound power	96 dBA	
Materials of Construction		
Pump motor	TEFC 7/8 HP DC	TEFC 7/8 HP DC
Compressor motor	1.0 HP AC Induction	1.0 HP AC Induction
Material hose	1/4 in. x 50-ft (blue)	1/4 in. x 15.2 m (blue)
Air hose	3/8 in. x 50-ft (clear)	3/8 in. x 15.2 m (clear)
Gun	G40 w RAC X tip	G40 w RAC X tip

Technical Specifications

FinishPro II 395 PC		
	US	Metric
Wetted materials on all models	zinc- and nickel-plated carbon steel, nylon, stainless steel, PTFE, Acetal, leather, UHMWPE, aluminum, tungsten carbide, polyethylene, fluoroelastomer, urethane	
Notes		
<i>* Startup pressures and displacement per cycle may vary based on suction condition, discharge head, air pressure, and fluid type.</i>		
<i>** Sound pressure measured 3 feet (1 meter) from equipment.</i>		
<i>Sound power measured per ISO-3744.</i>		

Graco Standard Warranty

Graco Standard Warranty

Graco warrants all equipment referenced in this document which is manufactured by Graco and bearing its name to be free from defects in material and workmanship on the date of sale to the original purchaser for use. With the exception of any special, extended, or limited warranty published by Graco, Graco will, for a period of twelve months from the date of sale, repair or replace any part of the equipment determined by Graco to be defective. This warranty applies only when the equipment is installed, operated and maintained in accordance with Graco's written recommendations.

This warranty does not cover, and Graco shall not be liable for general wear and tear, or any malfunction, damage or wear caused by faulty installation, misapplication, abrasion, corrosion, inadequate or improper maintenance, negligence, accident, tampering, or substitution of non-Graco component parts. Nor shall Graco be liable for malfunction, damage or wear caused by the incompatibility of Graco equipment with structures, accessories, equipment or materials not supplied by Graco, or the improper design, manufacture, installation, operation or maintenance of structures, accessories, equipment or materials not supplied by Graco.

This warranty is conditioned upon the prepaid return of the equipment claimed to be defective to an authorized Graco distributor for verification of the claimed defect. If the claimed defect is verified, Graco will repair or replace free of charge any defective parts. The equipment will be returned to the original purchaser transportation prepaid. If inspection of the equipment does not disclose any defect in material or workmanship, repairs will be made at a reasonable charge, which charges may include the costs of parts, labor, and transportation.

THIS WARRANTY IS EXCLUSIVE, AND IS IN LIEU OF ANY OTHER WARRANTIES, EXPRESS OR IMPLIED, INCLUDING BUT NOT LIMITED TO WARRANTY OF MERCHANTABILITY OR WARRANTY OF FITNESS FOR A PARTICULAR PURPOSE.

Graco's sole obligation and buyer's sole remedy for any breach of warranty shall be as set forth above. The buyer agrees that no other remedy (including, but not limited to, incidental or consequential damages for lost profits, lost sales, injury to person or property, or any other incidental or consequential loss) shall be available. Any action for breach of warranty must be brought within two (2) years of the date of sale.

GRACO MAKES NO WARRANTY, AND DISCLAIMS ALL IMPLIED WARRANTIES OF MERCHANTABILITY AND FITNESS FOR A PARTICULAR PURPOSE, IN CONNECTION WITH ACCESSORIES, EQUIPMENT, MATERIALS OR COMPONENTS SOLD BUT NOT MANUFACTURED BY GRACO. These items sold, but not manufactured by Graco (such as electric motors, switches, hose, etc.), are subject to the warranty, if any, of their manufacturer. Graco will provide purchaser with reasonable assistance in making any claim for breach of these warranties.

In no event will Graco be liable for indirect, incidental, special or consequential damages resulting from Graco supplying equipment hereunder, or the furnishing, performance, or use of any products or other goods sold hereto, whether due to a breach of contract, breach of warranty, the negligence of Graco, or otherwise.

FOR GRACO CANADA CUSTOMERS

The Parties acknowledge that they have required that the present document, as well as all documents, notices and legal proceedings entered into, given or instituted pursuant hereto or relating directly or indirectly hereto, be drawn up in English. Les parties reconnaissent avoir convenu que la rédaction du présente document sera en Anglais, ainsi que tous documents, avis et procédures judiciaires exécutés, donnés ou intentés, à la suite de ou en rapport, directement ou indirectement, avec les procédures concernées.

Graco Information

For the latest information about Graco products, visit www.graco.com.

For patent information, see www.graco.com/patents.

TO PLACE AN ORDER, contact your Graco distributor or call 1-800-690-2894 to identify the nearest distributor.

All written and visual data contained in this document reflects the latest product information available at the time of publication.

Graco reserves the right to make changes at any time without notice.

Original instructions. This manual contains English. MM 334730

Graco Headquarters: Minneapolis

International Offices: Belgium, China, Japan, Korea

GRACO INC. AND SUBSIDIARIES • P.O. BOX 1441 • MINNEAPOLIS MN 55440-1441 • USA

Copyright 2015, Graco Inc. All Graco manufacturing locations are registered to ISO 9001.

www.graco.com

Revision F, January 2019