

REACTOR[®] A-25/A-XP1

PLURAL COMPONENT PROPORTIONER

3A1569K

EN

Air operated, electrically heated, plural component proportioner

A-25: For spraying or dispensing 1:1 ratio polyurethane foam formulations and other 1:1 fast setting materials.

A-XP1: For spraying or dispensing 1:1 ratio polyurea formulations and other 1:1 fast setting materials.

Not for use in explosive atmosphere or hazardous locations.

This model is field-configurable to the following nominal voltage ranges:

200-240 V ac, 1-phase

200-240 V ac, 3-phase

350-415 V ac, 3-phase

A-25:

2000 psi (14 MPa, 138 bar) Maximum Fluid Working Pressure

80 psi (550 kPa, 5.5 bar) Maximum Air Working Pressure

A-XP1:

3500 psi (24 MPa, 241 bar) Maximum Fluid Working Pressure

100psi (689 kPa, 6.9 bar) Maximum Air Working Pressure



Important Safety Instructions

Read all warnings and instructions in this manual. Save these instructions.

See page 10 for model information, including maximum working pressure and approvals.

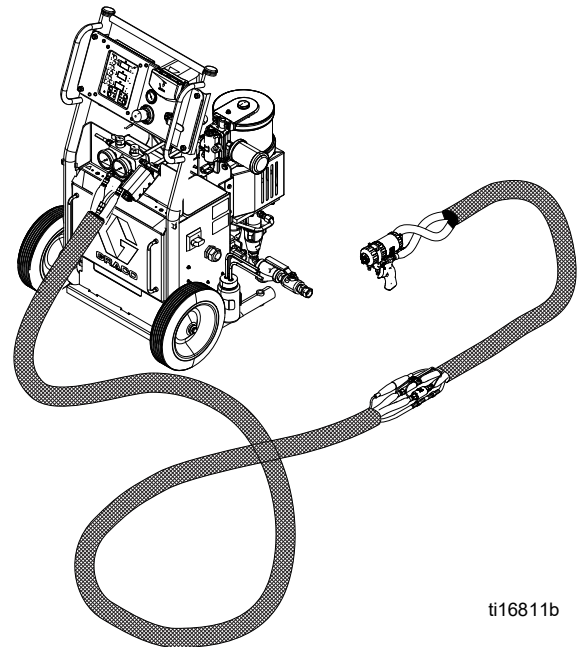

ti16811b



Contents

Proportioner Models	3	Fluid Circulation	31
Systems	3	Circulation Through Reactor	31
Related Manuals	4	Circulation Through Gun Manifold	32
Warnings	5	DataTrak Controls and Indicators	33
Important Two-Component Material Information .	8	DataTrak Operation	34
Isocyanate Conditions	8	Setup Mode	34
Material Self-ignition	9	Run Mode	34
Keep Components A and B Separate	9	Maintenance	35
Moisture Sensitivity of Isocyanates	9	Diagnostic Codes	36
Foam Resins with 245 fa Blowing Agents	9	Temperature Control Diagnostic Codes	36
Changing Materials	9	DataTrak Diagnostic Codes	36
Typical Installation, without Circulation	10	Dimensions	37
Typical Installation, with Circulation	11	Technical Specifications	38
Component Identification	12	California Proposition 65	39
Control Panel	13	Graco Standard Warranty	40
Temperature Controls and Indicators	14		
Setup	16		
Locate Reactor A-25/A-XP1	16		
Determine Power Source	16		
Electrical Requirements	16		
Configure to Supply Power	17		
Ground System	19		
Iso Pump Lubrication System Setup	19		
Fluid Supply Connections	19		
Air Supply Connection	19		
Recirculation / Pressure Relief Lines	20		
Install Fluid Temperature Sensor (FTS)	20		
Connect Heated Hose	20		
Close Gun Fluid Inlet Valves A and B	21		
Connect Whip Hose to Gun or Gun Fluid Manifold			
21			
Initial Startup	22		
Pressure Check Hose	22		
Set Temperatures	23		
Supply Wet-Cups with Throat Seal Liquid	24		
Spraying	25		
Spray Adjustments	26		
Park	27		
Pressure Relief Procedure	27		
Shutdown	27		
Flushing	28		
Operation	29		
Daily Start-up Procedure	29		

Proportioner Models

All proportioners can be configured to operate on 200-240 V ac, 1-phase (2-wire + ground/PE); 200-240 V ac, 3-phase Delta (3-wire + ground/PE); or 300-415 V ac, 3-phase Wye (4-wire + ground/PE).

Part	Maximum Working Pressure psi (MPa, bar)	Maximum Air Working Set Pressure psi (kPa, bar)	Includes:		Approvals
			Data Trak (cycle count only)	Wheels	
262572	2000 (14, 138)	80 (550, 5.5)	---	---	 Intertek 3172585 <small>Conforms to ANSI/UL Std. 499 Certified to CAN/CSA Std. C22.2 No. 88</small>
262614	2000 (14, 138)	80 (550, 5.5)	24A592	✓	
24Y164	3500 (24, 241)	100 (689, 6.9)	---	---	
24Y165	3500 (24, 241)	100 (689, 6.9)	24A592	✓	

Systems

All systems include a proportioner, spray gun, and 60 ft (18.3 m) of heated hose.



Part	Maximum Working Pressure psi (MPa, bar)	Proportioner (see Typical Installation, without Circulation)	Heated Hose		Gun	
			50 ft (15 m)	10 ft (3 m)	Model	Part
P22614	2000 (14, 138)	262614	246678	25P770	Probler P2	GCP2R1
AP2614	2000 (14, 138)	262614	246678	25P770	Fusion® AP	246101
CS2614	2000 (14, 138)	262614	246678	25P770	Fusion CS	CS01RD
P22572	2000 (14, 138)	262572	246678	25P770	Probler P2	GCP2R1
AP2572	2000 (14, 138)	262572	246678	25P770	Fusion AP	246101
CS2572	2000 (14, 138)	262572	246678	25P770	Fusion CS	CS01RD
P2Y165	3500 (24, 241)	24Y165	246679	25P772	Probler P2	GCP2R0
APY165	3500 (24, 241)	24Y165	246679	25P772	Fusion AP	246100
P2Y164	3500 (24, 241)	24Y164	246679	25P772	Probler P2	GCP2R0
APY164	3500 (24, 241)	24Y164	246679	25P772	Fusion AP	246100
FP2614	2000 (14, 138)	262614	246678	25P770	Fusion PC	25P588
FP3614	2000 (14, 138)	262614	246678	25P770	Fusion PC	25P588
FP2572	2000 (14, 138)	262572	246678	25P770	Fusion PC	25P588
FPY165	3500 (24, 241)	24Y165	246679	25P772	Fusion PC	25P587
FPY164	3500 (24, 241)	24Y164	246679	25P772	Fusion PC	25P587

Related Manuals

Manual in English	Description
3A1570	Reactor A-25 Proportioner, Repair-Parts
309577	Proportioning Pump, Repair-Parts
309815	Feed Pump Kit, Instructions-Parts
309827	Feed Pump Air Supply Kit, Instructions-Parts
309852	Circulation and Return Tube Kit, Instructions-Parts
309572	Heated Hose, Instructions-Parts
309550	Fusion® AP Spray Gun, Instructions-Parts
312666	Fusion CS Spray Gun, Instructions-Parts
3A7314	Fusion PC Spray Gun, Instructions
313213	Probler P2 Spray Gun, Instructions-Parts
313541	DataTrak Kits, Installation-Parts
312796	NXT® Air Motor, Instructions-Parts

Warnings

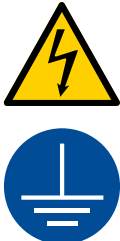
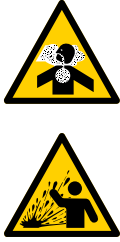
The following warnings are for the setup, use, grounding, maintenance, and repair of this equipment. The exclamation point symbol alerts you to a general warning and the hazard symbols refer to procedure-specific risks. When these symbols appear in the body of this manual, refer back to these Warnings. Product-specific hazard symbols and warnings not covered in this section may appear throughout the body of this manual where applicable.

 WARNING	
	<p>ELECTRIC SHOCK HAZARD</p> <p>This equipment must be grounded. Improper grounding, setup, or usage of the system can cause electric shock.</p> <ul style="list-style-type: none"> • Turn off and disconnect power at main switch before disconnecting any cables and before servicing or installing equipment. • Connect only to grounded power source. • All electrical wiring must be done by a qualified electrician and comply with all local codes and regulations.
	<p>TOXIC FLUID OR FUMES HAZARD</p> <p>Toxic fluids or fumes can cause serious injury or death if splashed in the eyes or on skin, inhaled or swallowed.</p> <ul style="list-style-type: none"> • Read Safety Data Sheet (SDS) for handling instructions and to know the specific hazards of the fluids you are using, including the effects of long-term exposure. • When spraying, servicing equipment, or when in the work area, always keep work area well ventilated and always wear appropriate personal protective equipment. See Personal Protective Equipment warnings in this manual. • Store hazardous fluid in approved containers, and dispose of it according to applicable guidelines.
	<p>PERSONAL PROTECTIVE EQUIPMENT</p> <p>Always wear appropriate personal protective equipment and cover all skin when spraying, servicing equipment, or when in the work area. Protective equipment helps prevent serious injury, including long-term exposure; inhalation of toxic fumes, mists or vapors; allergic reaction; burns; eye injury and hearing loss. This protective equipment includes but is not limited to:</p> <ul style="list-style-type: none"> • A properly fitting respirator, which may include a supplied-air respirator, chemically impermeable gloves, protective clothing and foot coverings as recommended by the fluid manufacturer and local regulatory authority. • Protective eyewear and hearing protection.
	<p>BURN HAZARD</p> <p>Equipment surfaces and fluid that's heated can become very hot during operation. To avoid severe burns:</p> <ul style="list-style-type: none"> • Do not touch hot fluid or equipment.



WARNING



FIRE AND EXPLOSION HAZARD

Flammable fumes, such as solvent and paint fumes, in **work area** can ignite or explode. To help prevent fire and explosion:

- Use equipment only in well ventilated area.
- Eliminate all ignition sources; such as pilot lights, cigarettes, portable electric lamps, and plastic drop cloths (potential static arc).
- Keep work area free of debris, including solvent, rags and gasoline.
- Do not plug or unplug power cords, or turn power or light switches on or off when flammable fumes are present.
- Ground all equipment in the work area. See **Grounding** instructions.
- Use only grounded hoses.
- Hold gun firmly to side of grounded pail when triggering into pail.
- If there is static sparking or you feel a shock, **stop operation immediately**. Do not use equipment until you identify and correct the problem.
- Keep a working fire extinguisher in the work area.



SKIN INJECTION HAZARD







High-pressure fluid from gun, hose leaks, or ruptured components will pierce skin. This may look like just a cut, but it is a serious injury that can result in amputation. **Get immediate surgical treatment.**

- Engage trigger lock when not spraying.
- Do not point gun at anyone or at any part of the body.
- Do not put your hand over the fluid outlet.
- Do not stop or deflect leaks with your hand, body, glove, or rag.
- Follow the **Pressure Relief Procedure** when you stop spraying and before cleaning, checking, or servicing equipment.
- Tighten all fluid connections before operating the equipment.
- Check hoses and couplings daily. Replace worn or damaged parts immediately.





WARNING

 	<p>EQUIPMENT MISUSE HAZARD</p> <p>Misuse can cause death or serious injury.</p> <ul style="list-style-type: none"> • Do not operate the unit when fatigued or under the influence of drugs or alcohol. • Do not exceed the maximum working pressure or temperature rating of the lowest rated system component. See Technical Data in all equipment manuals. • Use fluids and solvents that are compatible with equipment wetted parts. See Technical Data in all equipment manuals. Read fluid and solvent manufacturer's warnings. For complete information about your material, request MSDS from distributor or retailer. • Do not leave the work area while equipment is energized or under pressure. Turn off all equipment and follow the Pressure Relief Procedure when equipment is not in use. • Check equipment daily. Repair or replace worn or damaged parts immediately with genuine manufacturer's replacement parts only. • Do not alter or modify equipment. • Use equipment only for its intended purpose. Call your distributor for information. • Route hoses and cables away from traffic areas, sharp edges, moving parts, and hot surfaces. • Do not kink or over bend hoses or use hoses to pull equipment. • Keep children and animals away from work area. • Comply with all applicable safety regulations.
	<p>PRESSURIZED ALUMINUM PARTS HAZARD</p> <p>Use of fluids that are incompatible with aluminum in pressurized equipment can cause serious chemical reaction and equipment rupture. Failure to follow this warning can result in death, serious injury, or property damage.</p> <ul style="list-style-type: none"> • Do not use 1,1,1-trichloroethylene, methylene chloride, other halogenated hydrocarbon solvents or fluids containing such solvents. • Many other fluids may contain chemicals that can react with aluminum. Contact your material supplier for compatibility.
 	<p>THERMAL EXPANSION HAZARD</p> <p>Fluids subjected to heat in confined spaces, including hoses, can create a rapid rise in pressure due to the thermal expansion. Over-pressurization can result in equipment rupture and serious injury.</p> <ul style="list-style-type: none"> • Open a valve to relieve the fluid expansion during heating. • Replace hoses proactively at regular intervals based on your operating conditions.
 	<p>MOVING PARTS HAZARD</p> <p>Moving parts can pinch, cut or amputate fingers and other body parts.</p> <ul style="list-style-type: none"> • Keep clear of moving parts. • Do not operate equipment with protective guards or covers removed. • Pressurized equipment can start without warning. Before checking, moving, or servicing equipment, follow the Pressure Relief Procedure and disconnect all power sources.



Important Two-Component Material Information

Isocyanate Conditions





Spraying or dispensing fluids that contain isocyanates creates potentially harmful mists, vapors, and atomized particulates.



- Read and understand the fluid manufacturer’s warnings and Safety Data Sheet (SDS) to know specific hazards and precautions related to isocyanates.
- Use of isocyanates involves potentially hazardous procedures. Do not spray with this equipment unless you are trained, qualified, and have read and understood the information in this manual and in the fluid manufacturer’s application instructions and SDS.
- Use of incorrectly maintained or mis-adjusted equipment may result in improperly cured material, which could cause off gassing and offensive odors. Equipment must be carefully maintained and adjusted according to instructions in the manual.
- To prevent inhalation of isocyanate mists, vapors and atomized particulates, everyone in the work area must wear appropriate respiratory protection. Always wear a properly fitting respirator, which may include a supplied-air respirator. Ventilate the work area according to instructions in the fluid manufacturer’s SDS.
- Avoid all skin contact with isocyanates. Everyone in the work area must wear chemically impermeable gloves, protective clothing and foot coverings as recommended by the fluid manufacturer and local regulatory authority. Follow all fluid manufacturer recommendations, including those regarding handling of contaminated clothing. After spraying, wash hands and face before eating or drinking.
- Hazard from exposure to isocyanates continues after spraying. Anyone without appropriate personal protective equipment must stay out of the work area during application and after application for the time period specified by the fluid manufacturer. Generally this time period is at least 24 hours.
- Warn others who may enter work area of hazard from exposure to isocyanates. Follow the recommendations of the fluid manufacturer and local regulatory authority. Posting a placard such as the following outside the work area is recommended:

 WARNING	
	TOXIC FUMES HAZARD
DO NOT ENTER DURING SPRAY FOAM APPLICATION OR FOR ___ HOURS AFTER APPLICATION IS COMPLETE	
DO NOT ENTER UNTIL:	
DATE: _____	
TIME: _____	

Material Self-ignition

				
Some materials may become self-igniting if applied too thick. Read material manufacturer's warnings and Safety Data Sheet (SDS).				

Keep Components A and B Separate

				
Cross-contamination can result in cured material in fluid lines which could cause serious injury or damage equipment. To prevent cross-contamination:				
<ul style="list-style-type: none"> • Never interchange component A and component B wetted parts. • Never use solvent on one side if it has been contaminated from the other side. 				

Moisture Sensitivity of Isocyanates

Exposure to moisture (such as humidity) will cause ISO to partially cure, forming small, hard, abrasive crystal that become suspended in the fluid. Eventually a film will form on the surface and the ISO will begin to gel, increasing in viscosity.

NOTICE				
Partially cured ISO will reduce performance and the life of all wetted parts.				
<ul style="list-style-type: none"> • Always use a sealed container with a desiccant dryer in the vent, or a nitrogen atmosphere. Never store ISO in an open container. • Keep the ISO pump wet cup or reservoir (if installed) filled with appropriate lubricant. The lubricant creates a barrier between the ISO and the atmosphere. • Use only moisture-proof hoses compatible with ISO. • Never use reclaimed solvents, which may contain moisture. Always keep solvent containers closed when not in use. • Always lubricate threaded parts with an appropriate lubricant when reassembling. 				

NOTE: The amount of film formation and rate of crystallization varies depending on the blend of ISO, the humidity, and the temperature.

Foam Resins with 245 fa Blowing Agents

Some foam blowing agents will froth at temperatures above 90°F (33°C) when not under pressure, especially if agitated. To reduce frothing, minimize preheating in a circulation system.

Changing Materials

NOTICE	
Changing the material types used in your equipment requires special attention to avoid equipment damage and downtime.	
<ul style="list-style-type: none"> • When changing materials, flush the equipment multiple times to ensure it is thoroughly clean. • Always clean the fluid inlet strainers after flushing. • Check with your material manufacturer for chemical compatibility. • When changing between epoxies and urethanes or polyureas, disassemble and clean all fluid components and change hoses. Epoxies often have amines on the B (hardener) side. Polyureas often have amines on the B (resin) side. 	

Typical Installation, without Circulation

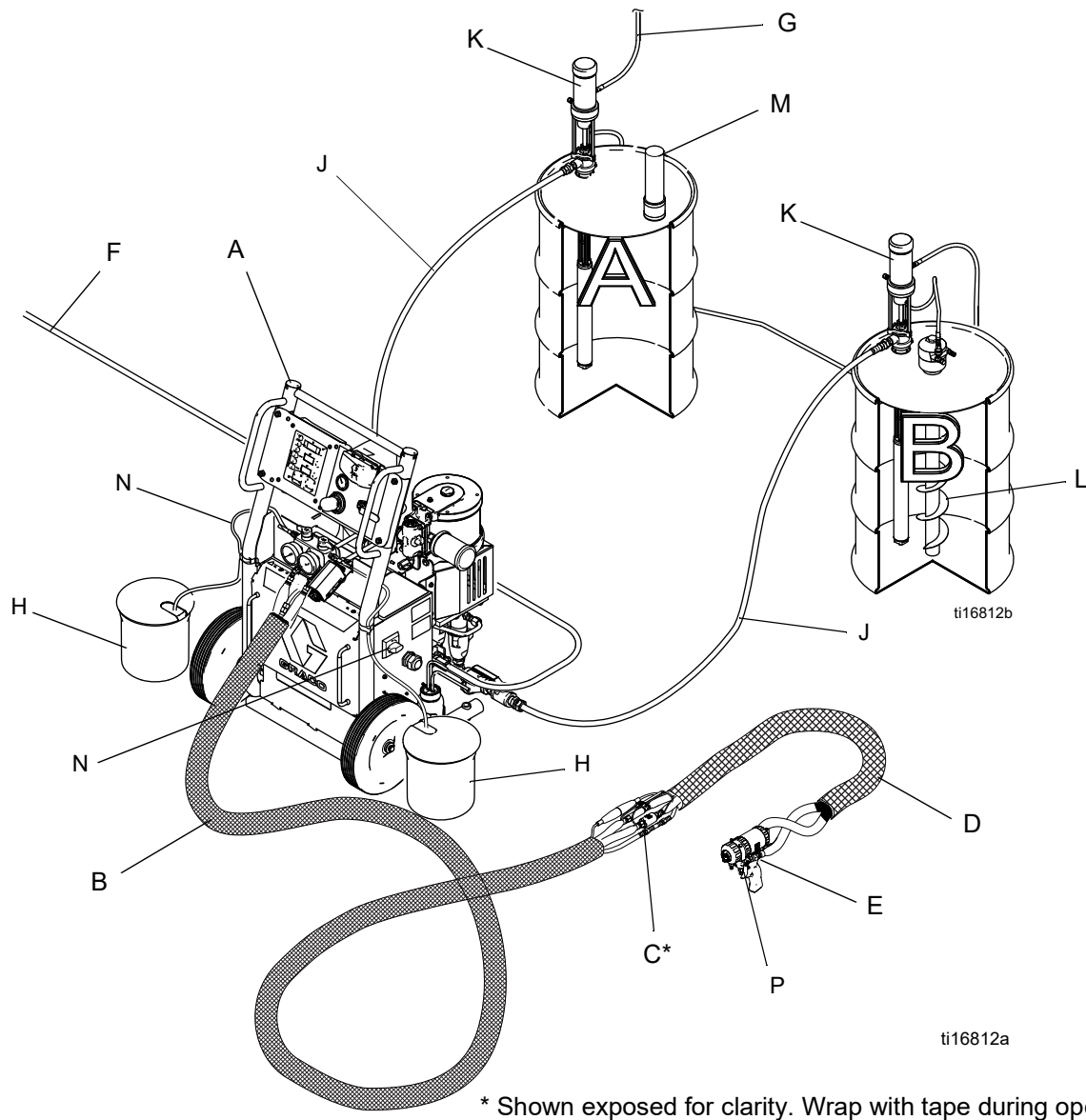
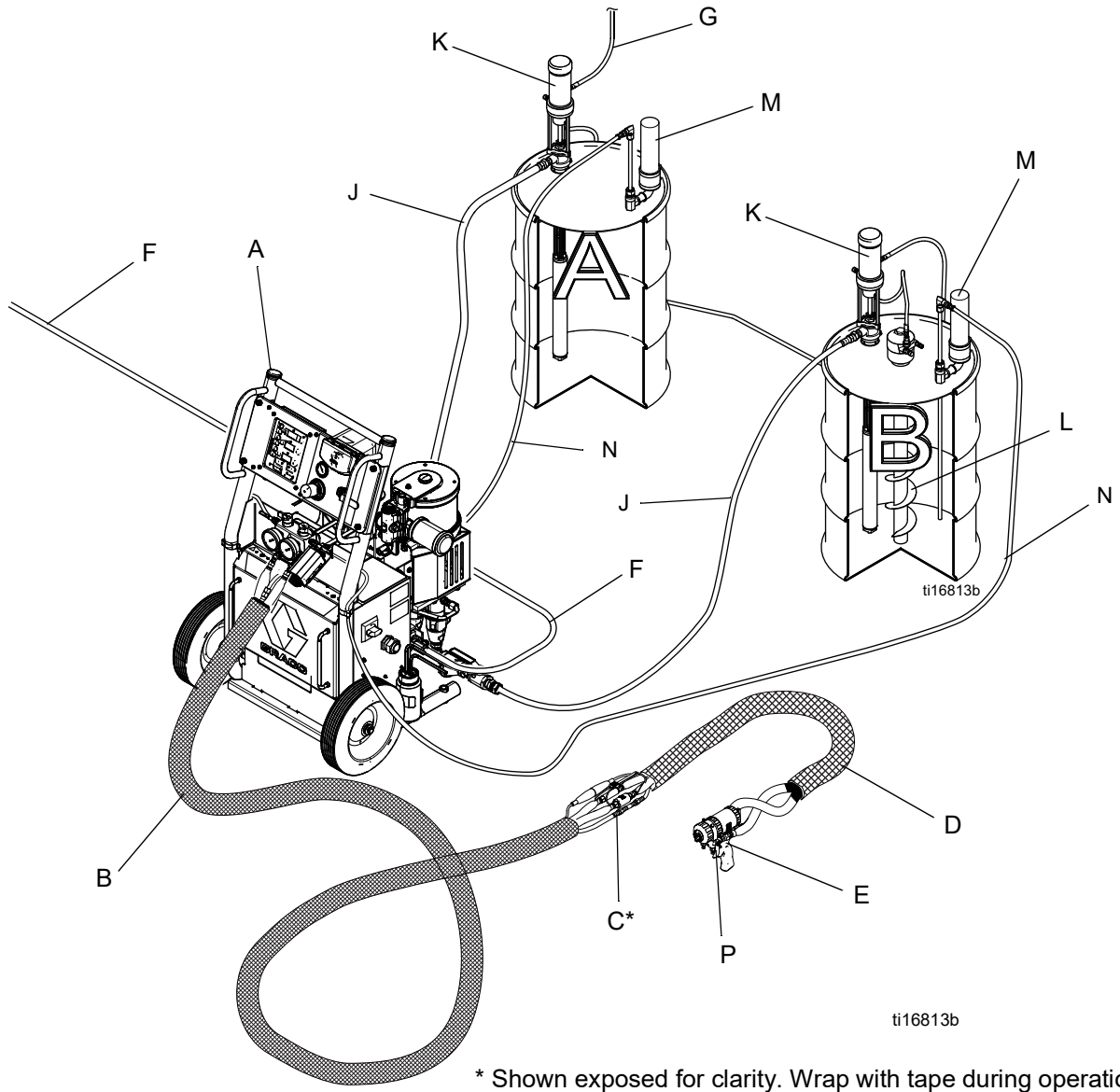

FIG. 1: Typical Installation, without Circulation

Key for FIG. 1

- | | | | |
|---|--------------------------------------|---|----------------------------------|
| A | Reactor Proportioner | M | Desiccant Dryer |
| B | Heated Hose | N | Bleed Lines/Over Pressure Relief |
| C | Fluid Temperature Sensor (FTS) | P | Gun Fluid Manifold |
| D | Heated Whip Hose | | |
| E | Spray Gun | | |
| F | Proportioner and Gun Air Supply Hose | | |
| G | Feed Pump Air Supply Lines | | |
| H | Waste Containers | | |
| J | Fluid Supply Lines | | |
| K | Feed Pumps | | |
| L | Agitator (if required) | | |

Typical Installation, with Circulation



* Shown exposed for clarity. Wrap with tape during operation.

FIG. 2: Typical Installation, with Circulation

Key for FIG. 2

- | | | | |
|---|--------------------------------------|---|---|
| A | Reactor Proportioner | M | Desiccant Dryer |
| B | Heated Hose | N | Recirculation/Over Pressure Relief Return Hoses |
| C | Fluid Temperature Sensor (FTS) | P | Gun Fluid Manifold |
| D | Heated Whip Hose | | |
| E | Spray Gun | | |
| F | Proportioner and Gun Air Supply Hose | | |
| G | Feed Pump Air Supply Lines | | |
| J | Fluid Supply Lines | | |
| K | Feed Pumps | | |
| L | Agitator (if required) | | |

Component Identification

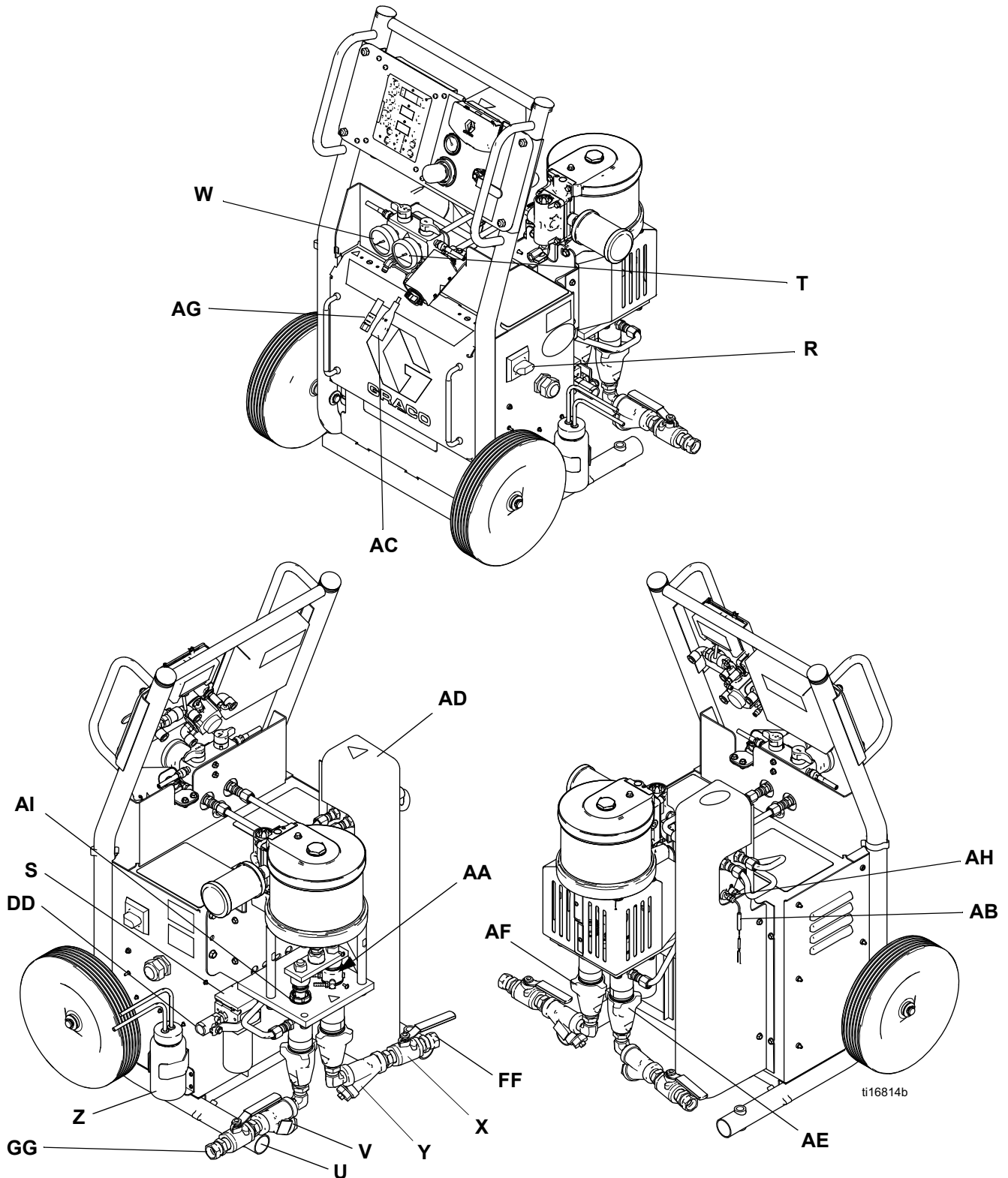
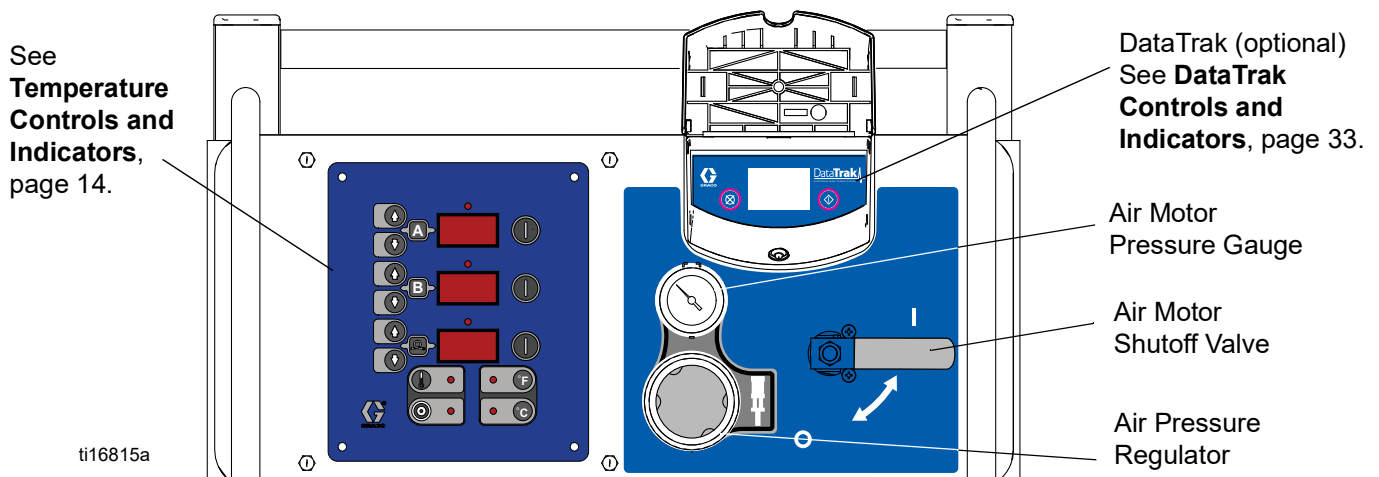

FIG. 3: Typical Installation

Key:

- R Main Disconnect Switch** - Controls power to heating circuits.
- S Main Air Filter** - Filters system air supply.
- T Resin (B) Pressure Gauge** - Displays pressure in resin proportioning system (B side).
- U Resin (B) - Inlet Supply Valve**
- V Resin (B) Fluid Y-Strainer** - (20 mesh)
- W ISO (A) Pressure Gauge** - Displays pressure in isocyanate proportioning system (A side).
- X ISO (A) - Inlet Supply Valve**
- Y ISO (A) Fluid Y-Strainer** - (20 mesh)
- Z ISO (A) Pump Lube System** - Behind Proportioner shroud. (A side only)
- AA ISO (A) - Packing Nut and Lube Cup** - (A side only)
- AB *Primary Heater Thermocouples** - Senses temperature of primary heater and inputs that information.
- AC FTS Jumper Harness** - Carries electrical signal from FTS sensor in isocyanate hose to hose temperature controller.
- AD Primary Heaters** - Heats material to required dispensing temperature.
- AE ISO (A) - (Isocyanate) Proportioning Pump** - Draws in and dispenses a fixed volume of isocyanate to gun.
- AF Resin (B) Proportioning Pump** - Draws in and dispenses a fixed volume of resin to gun.
- AG Hose Heat Connection Termination Box** - Connects power to heated hoses.
- AH *Primary Heater Over-Temperature Switches** - Sends signal to temperature controller if heater exceeds maximum temperature condition.
- AI Resin (B) Pump Wet Cup** - Access for daily wet cup refill.
- DD Main Air Inlet Ball Valve** - (1/2 NPT female fitting)
- FF ISO (A) Inlet - Fitting** (3/4 swivel fitting)
- GG Resin (B) Inlet - Fitting** (3/4 swivel fitting)

Control Panel



Temperature Controls and Indicators

NOTICE

To prevent damage to the softkey buttons, do not press the buttons with sharp objects such as pens, plastic cards, or fingernails.

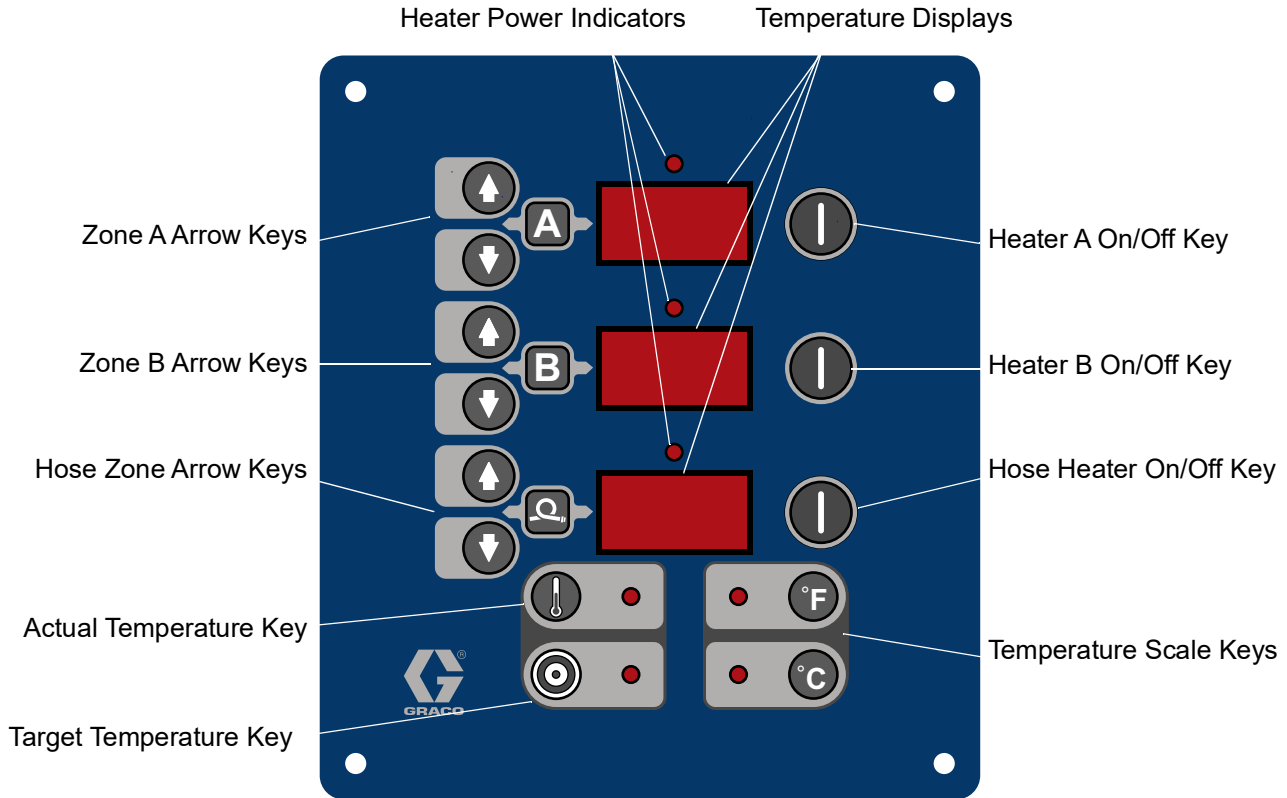

Main Power Switch

Located on right side of unit, see FIG. 3, page 12. Turns

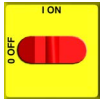
heater power ON  and OFF . Does not turn heater zones or pumps on.

Actual Temperature Key/LED

Press  to display actual temperature.



Press and hold  to display electrical current.

Target Temperature Key/LED

Press  to display target temperature.

Press and hold  to display heater control circuit board temperature.

Temperature Scale Keys/LEDs



Press  or  to change temperature scale.

Heater Zone On/Off Keys/LEDs

Press  to turn heater zones on and off. Also clears heater zone diagnostic codes, see page 36.

NOTE: LEDs flash when heater zones are on. The duration of each flash shows the extent that the heater is turned on.

Temperature Arrow Keys

Press , then press  or  to adjust temperature settings in 1 degree increments.

Temperature Displays

Show actual temperature or target temperature of heater zones, depending on selected mode. Defaults to actual at startup. Range is 32-190°F (0-88°C) for A and B, 32-180°F (0-82°C) for hose.

Circuit Breakers



Located inside Reactor cabinet.

Ref.	Size		Component
	A-25	A-XP1	
CB1	50 A	50 A	Hose Secondary (single)
CB2	30 A	30 A	Hose Primary (double)
CB3	25 A	30 A	Heater A (double)
CB4	25 A	30 A	Heater B (double)

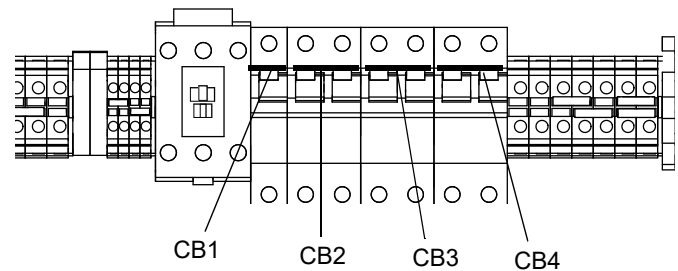

ti17569a

Setup

Locate Reactor A-25/A-XP1



1. Locate Reactor A-25 on a level surface and bolt in place to the floor with 3/8 in. (10 mm) bolts, unless the Reactor needs to remain portable.
 - Two bolts through the 2 in. (50 mm) deep caster bushings in the rear.
 - Two bolts through the 3-5/8 in. (168 mm) deep caster bushings in the front.
2. Do not expose Reactor to rain.
3. If you need to move the machine, add optional wheel kit.
4. Lift with hoist only from bar spanning across top of cart.

Determine Power Source

Reactor A-25 can be wired to three types of power source:

- 200-240 V ac, 1-phase (2-wire + ground/PE)
- 200-240 V ac, 3-phase Delta (3-wire + ground/PE)
- 350-415 V ac, 3-phase Wye (4 wire + ground/PE) (nominal line-to-neutral voltage: 200-240 V ac)

Electrical Requirements

				
<p>Improper wiring may cause electric shock or other serious injury if work is not performed properly.</p> <ul style="list-style-type: none"> • Have a qualified electrician connect power and ground to main power switch terminals and ground lug. • Ensure your installation complies with all National, State, and Local safety and fire codes. • Ensure that incoming power is disconnected and locked out at the source. 				

Power cord is not supplied.

Configure to Supply Power



Both cord connection AND jumper positioning steps on page 18 must be completed.

Step One - Connect Electrical Cord

Disregard terminal numbers on disconnect switch blocks. Wire to positions shown. Terminals will accept up to #8 AWG (10 mm²) conductors.

1. Using a flat screw driver, turn cover fasteners 90° counterclockwise. Lift and pull the front cover away.
2. Connect main power cord to electrical console as follows:
 - a. Feed power cord through strain relief (SR) on right side of unit. Push black die release lever (RL) down to release contacts block (PD) for easy wiring.

NOTE: Strain relief accepts cords 0.59 to 1.0 in. (15-25 mm) diameter.

NOTE: A-XP1 disconnect cannot be detached from the frame.

- b. Connect power leads to Power Disconnect Switch (PD). Snap contacts block (PD) back onto switch.
- c. Tighten strain relief nut.
- d. Connect ground wire to ground lug (GL).

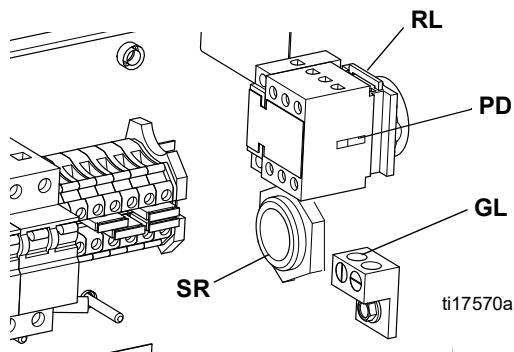

3. Replace lower front shroud. Reinstall the two screws retained in Step 1.

200-240 V ac, 1-phase: Use a screwdriver to connect two power leads to the top two middle terminal positions as shown. Connect green to ground (GND). See page 18 for proper jumper positions.

Disregard terminal numbers on disconnect switch blocks. Wire to positions shown.

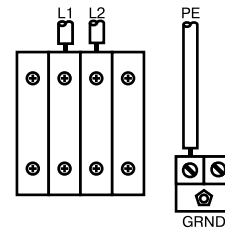

200-240 V ac, 3-phase Delta: Use a screwdriver to connect three power leads to top three left terminals as shown. Connect green to ground (GND). See page 18 for proper jumper positions.

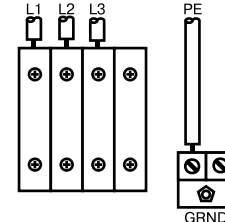

350-415 V ac, 3-phase Wye: Use a screwdriver to connect four power leads to the top terminals as shown. Connect neutral only to N. Connect green to ground (GND). See page 18 for proper jumper positions.

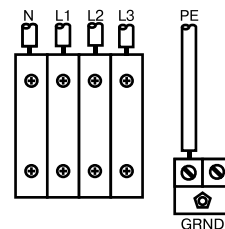

Step Two - Install Power Jumpers

Find location for power jumpers which are in a plastic bag tie wrapped to the ground lug.

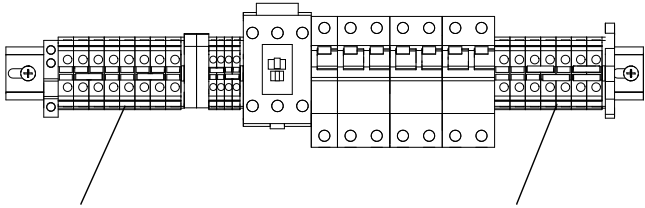

Heater Jumpers

Install Power Jumpers

ti17569a

1. Turn screws counter-clockwise on the upper part of the shroud until they stop. Pull door up and out.
2. Install red jumpers from the storage bag to the positions shown for your power.
 - Push the jumper firmly into the new position.
 - If necessary, a flat-blade screwdriver can be used under the ridge on the side of the jumper to remove them.
3. Replace front shroud.

Step Two

TB2

Terminal Blocks

Install red jumpers

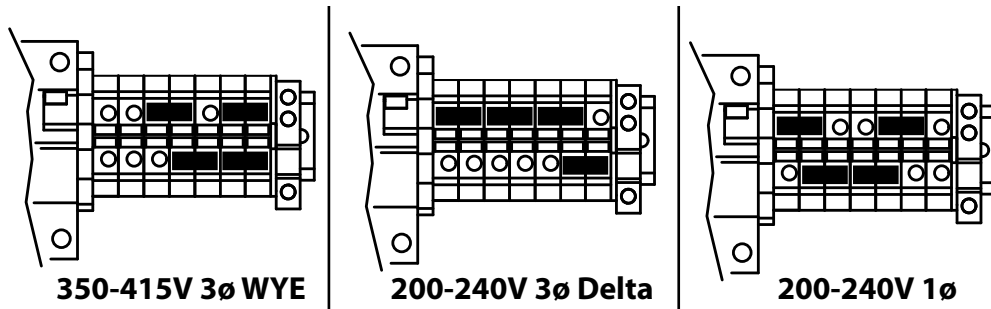

350-415V 3Ø WYE

200-240V 3Ø Delta

200-240V 1Ø

Step Three - Reposition Heater Jumpers (if necessary)

Find location of Heater Jumpers.

Machines are shipped with heaters wired for 6000 watts. To reposition heater jumpers for 3000 watts, change jumper positions as shown below.

1. Turn screws counter-clockwise on the upper part of the shroud and remove by pulling them out.
2. Move red jumpers from the storage positions to the positions shown for your power.
 - A flat-blade screwdriver can be used under the ridge on the side of the jumper to remove them.
 - Push the jumper firmly into the new position.
3. Replace lower front shroud.

Step Three

TB2

Terminal Blocks

Position red jumpers

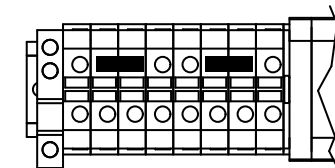

A-25: 6000 WATTS
A-XP1: 10,200 WATTS

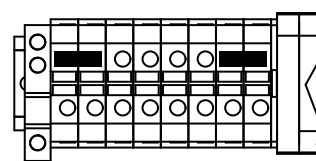

A-25: 3000 WATTS
A-XP1: 5100 WATTS

Ground System

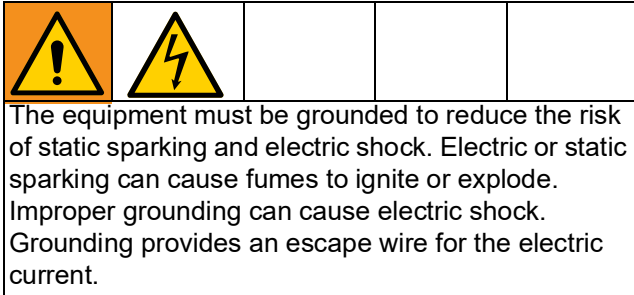

- **Reactor:** is grounded through power cord; see **Configure to Supply Power**, page 17.
- **Spray gun:** connect whip hose ground wire to FTS; see **Recirculation / Pressure Relief Lines**, page 20. Do not disconnect wire or spray without whip hose.
- **Fluid supply containers:** follow your local code.
- **Object being sprayed:** follow your local code.
- **Solvent pails used when flushing:** follow your local code. Use only metal pails that are conductive. Place them on a grounded surface. Do not place pail on a non-conductive surface, such as paper or cardboard, which interrupts grounding continuity.
- **To maintain grounding continuity when flushing or relieving pressure,** hold a metal part of spray gun firmly to the side of a grounded metal pail, then trigger gun.

Iso Pump Lubrication System Setup

Prepare isocyanate pump lubrication system as follows:

1. Lift lubricant reservoir out of bracket and remove reservoir from cap.
2. Fill reservoir 3/4 full with TSL.
3. Thread reservoir onto cap assembly and place it into bracket.

NOTE: The lubrication system is now ready for operation; no priming is required.

Fluid Supply Connections

Feed pumps are typically used. Siphon feeding is not recommended. Connect material supply to inlets of proportioning unit as follows:

1. Connect fluid inlet ball valves (U,X) and y-strainers (V, Y) to pump inlets.
2. Ensure the A- and B- inlet ball valves (U,X) on proportioning unit are closed.
3. Connect and tighten B- supply hose (J) to 3/4 NPT swivel fitting (GG) on B- inlet ball valve (U), and to resin transfer pump.

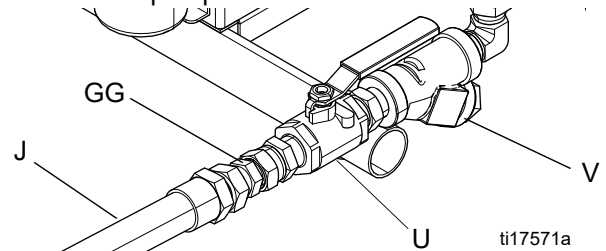

4. Connect and tighten A- supply hose (BB) to 1/2 NPT swivel fitting (FF) on A- inlet ball valve (X), and to isocyanate transfer pump. See FIG. 3, page 12.

Air Supply Connection

Connect main air supply (F) to air inlet 1/2 in. npt (f) valve (DD) at air filter (S). Hose fitting requires a 1/2 NPT male fitting.

Use a minimum of 3/8 in. ID air line (not supplied) to deliver air supply to proportioning unit. Use 1/2 in. ID hose if over 15 ft long. The main air supply must be clean and free of oil and contaminants.

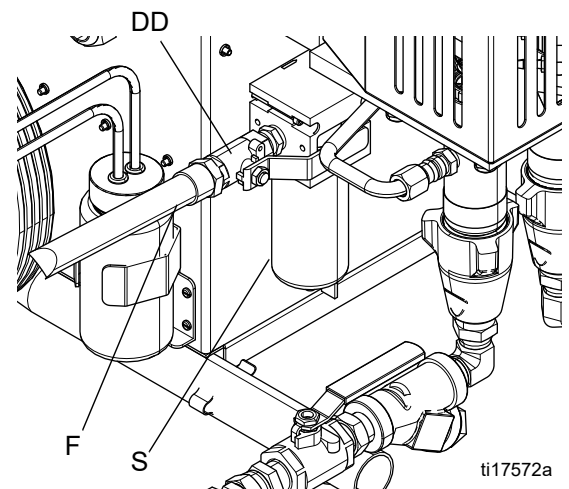

Recirculation / Pressure Relief Lines



Do not install shutoffs downstream of the PRESSURE RELIEF/SPRAY valve outlets (BA, BB). The valves function as over pressure relief valves when set to SPRAY. Lines must be open so valves can automatically relieve pressure when machine is operating.

If circulating fluid back to the supply drums, use high pressure hose rated to withstand the maximum working pressure of this equipment.

If Recirculating to Supply Drum: Connect high pressure hose (R) to relief fittings (BA, BB) of both PRESSURE RELIEF/SPRAY valves. Route hose back to component A and B drums. Refer to manual 309852.

Alternate recirculation hoses (requires adapter fittings):

249508 - ISO (A) (moisture guard) red hose, 1/4 in. (6 mm) ID; #5 JIC fittings (m x f); 35 ft (10.7 m) long.

249509 - Resin (B) blue hose; 1/4 in. (6 mm) ID, #6 JIC fittings (m x f), 35 ft (10.7 m) long.

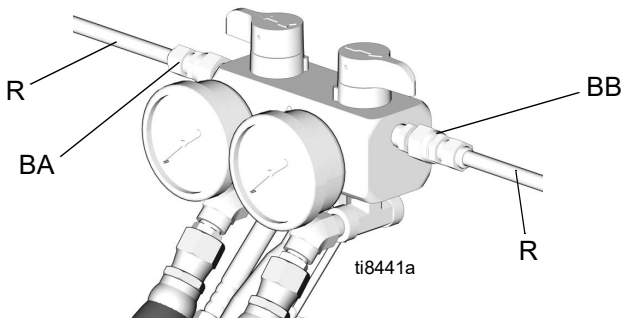

Install Fluid Temperature Sensor (FTS)

Install FTS between main hose and whip hose. See Heated Hose manual for instructions.

Connect Heated Hose

See heated hose manual for detailed instructions for Graco heated hoses.

NOTICE

The fluid temperature sensor (FTS) and whip hose must be used with heated hose; see page 20. Hose length, including whip hose, must be 60 ft (18.3 m) minimum.

1. Turn main power OFF.
2. Assemble heated hose sections, FTS, and whip hose. See Heated Hose manual for instructions.
3. Connect A and B hoses to A and B outlets on Reactor fluid manifold (FM). Hoses are color coded: red for component A (ISO), blue for component B (RES). Fittings are sized to prevent connection errors.

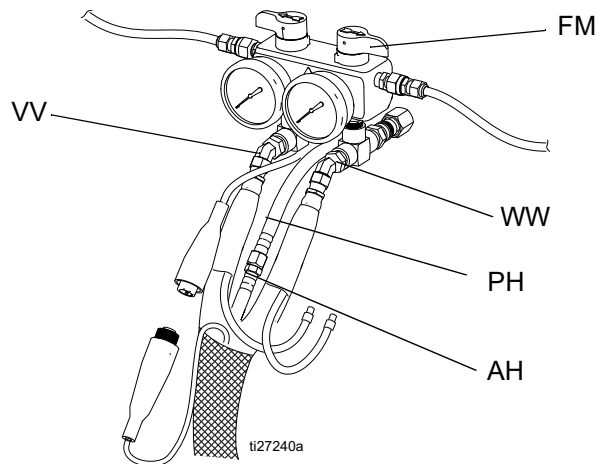

NOTE: Manifold hose fittings (VV, WW) allow use of 1/4 in. and 3/8 in. ID Reactor heated fluid hoses.

4. Connect heated hose air line (AH) to proportioner air hose.

NOTE: For proportioners with termination box (TB), follow step 5. For proportioners with electrical splice connectors (NN) follow step 6. Connect FTS cables (SS).

5. Connect hose power wires to terminal block (C) on termination box (TB). Remove box cover (D) and loosen lower strain relief (E). Route wires through strain relief and fully insert into terminal block (A and B hose wire positions are not important). Torque terminal connector screws (C) to 35-50 in-lb (4.0-5.6 N•m). Fully tighten strain relief screws and replace cover.

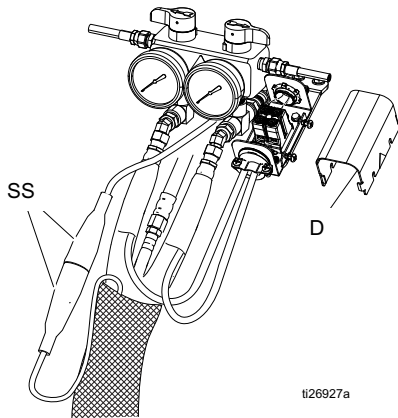

6. Connect cables (SS). Connect electrical connectors (NN). Be sure cables have slack when hose bends. Wrap cable and electrical connections with electrical tape.

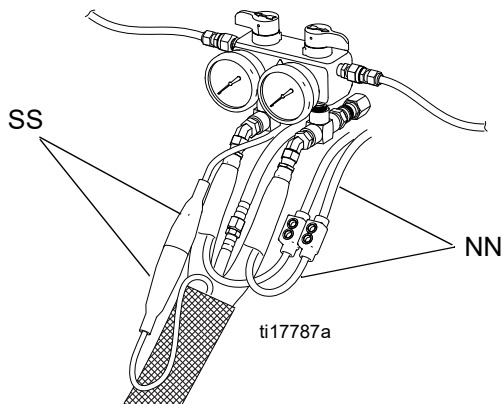

Close Gun Fluid Inlet Valves A and B

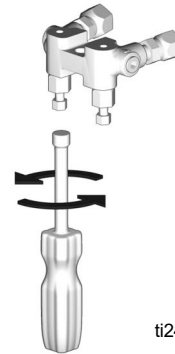

Fusion AP Gun shown.

Connect Whip Hose to Gun or Gun Fluid Manifold

For Probler P2 guns: Connect hoses to inlet valves.



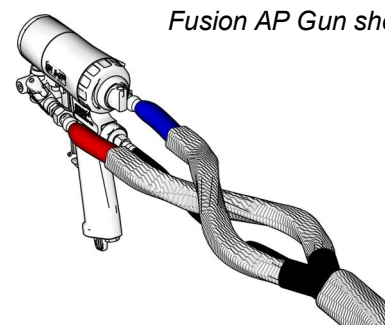

For Fusion guns: Connect hoses to inlet manifold. Do not connect manifold to gun.

1. Overlap A and B component hoses and assemble to gun or gun manifold fittings as shown.
2. Tighten fittings to A and B component hoses. Ensure hose remains flat after fittings are tightened. Loosen and retighten fittings as necessary to eliminate any torque on hoses.



Fusion AP Gun shown.

Initial Startup

				
Do not operate Reactor without all covers and shrouds in place.				

				
Always provide two grounded waste containers to keep component A and component B fluids separate.				

Load Fluid with Feed Pumps

The Reactor is tested with oil at the factory. Flush out the oil with a compatible solvent before spraying; see **Flushing**, page 28.

1. Check that Setup process is complete; see **Setup**, page 16.
2. Turn on component B agitator, if used.
3. Turn both PRESSURE RELIEF/SPRAY valves (SA, SB) to SPRAY.

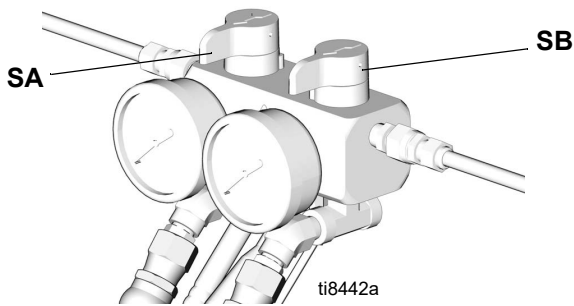

6. Purge air from hoses.

- a. **For Probler P2 guns:** Loosen hose fittings and bleed out air until air-free fluid comes from hoses.
- b. **For Fusion guns:** Hold gun fluid manifold over two grounded waste containers. Open fluid valves A and B until clean, air-free fluid comes from valves. Close valves.

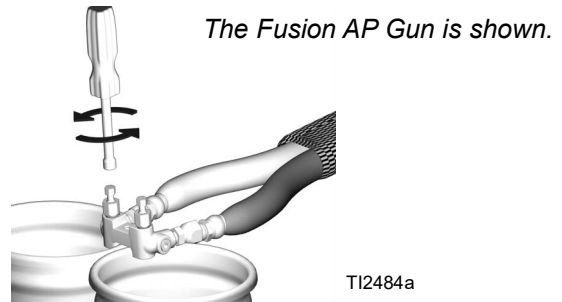

4. Open both fluid valves (FV).

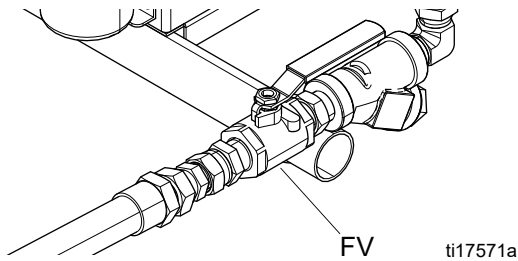

Pressure Check Hose







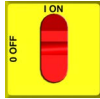

See hose manual. Pressure check for leaks. If no leaks, wrap hose and electrical connections to protect from damage.

5. Start feed pumps. Do not start proportioner air motor or pumps.

Set Temperatures





Refer to **Setup**, page 16.



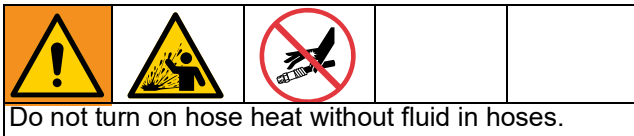

1. Turn main power ON .
2. Press  or  to change temperature scale.
3. Press  to display target temperatures.
4. To set  heat zone target temperature, press  or  until display shows desired temperature. Repeat for  and  zones.

NOTE: For  zone only, if FTS is disconnected at startup, display will show hose current (0A). See step 9.

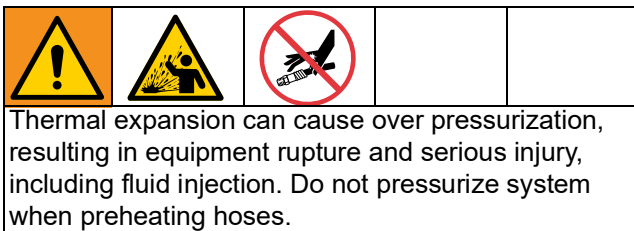





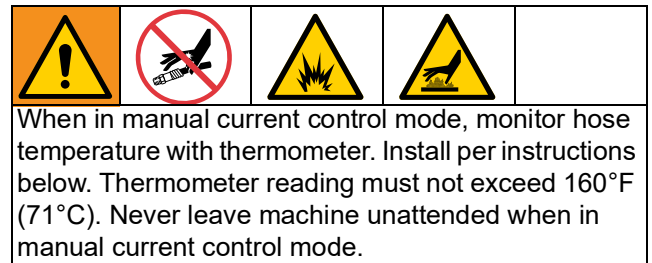

5. Turn on  heat zone by pressing . Preheat hose (15-60 min). Indicator will flash very slowly when fluid reaches target temperature. Display shows actual fluid temperature in hose near FTS.

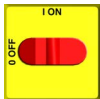



6. Turn on  and  heat zones by pressing  for each zone.
7. Hold  to view electrical currents for each zone.
8. Hold  to view heater control circuit board temperature.
9. **Manual current control mode only:**



- a. If FTS is disconnected or display shows diagnostic code E04, turn main power switch OFF  then ON  to clear diagnostic code and enter manual current control mode.  display will show current to hose. Current is not limited by target temperature.
- b. Press  or  to adjust current setting.
- c. To prevent overheating, install hose thermometer close to gun end, within operator view. Insert thermometer through foam cover of A component hose so stem is next to inner tube. Thermometer reading will be about 20°F less than actual fluid temperature.
- d. If thermometer reading exceeds 160°F (71°C), reduce current with  key.

Supply Wet-Cups with Throat Seal Liquid

				
<p>Pump rod and connecting rod move during operation. Moving parts can cause serious injury such as pinching or amputation. Keep hands and fingers away from wet-cup during operation. Close main air valve before filling wet-cup.</p>				

1. **Component A (ISO) Pump:** Keep reservoir (Z) 3/4 filled with TSL. Wet-cup piston circulates TSL through wet-cup to carry away isocyanate film on displacement rod. Change the fluid in the reservoir when it becomes milky-looking.
2. **Component B (Resin) Pump:** Check felt washers in packing nut/wet-cup (AK) daily. Keep saturated with TSL to prevent material from hardening on displacement rod. Replace felt washers when worn or contaminated with hardened material.

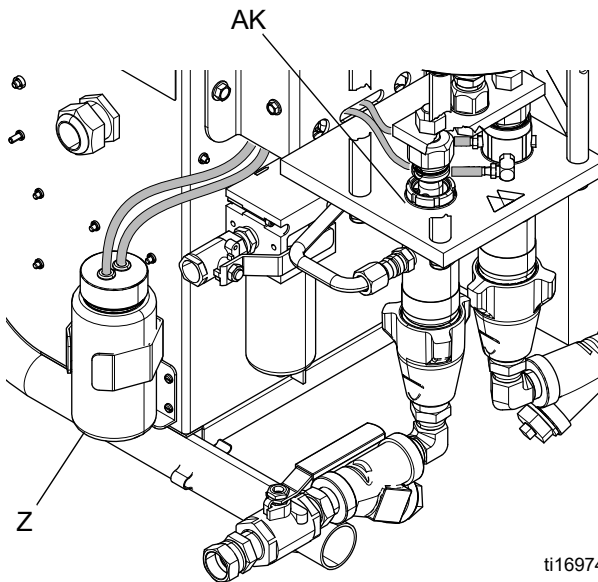

ti16974a

Spraying

The Fusion AP gun is shown.

1. After reaching spray temperatures, engage gun piston safety lock.



2. Close gun fluid inlet valves A and B.

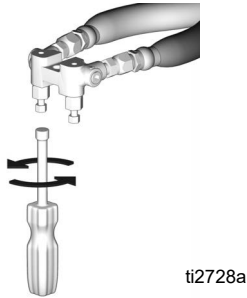

3. Attach gun fluid manifold. Connect gun air line. Open air line valve.

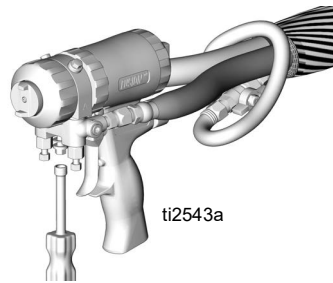

4. Set PRESSURE RELIEF/SPRAY valves (SA, SB) to SPRAY.

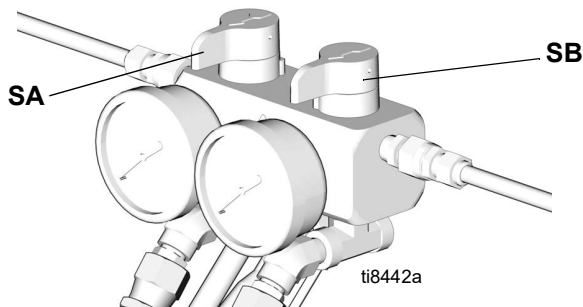

5. Open air inlet ball valve (DD).

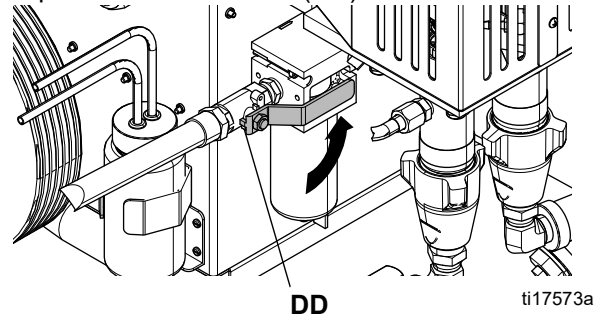

6. Turn the air regulator counterclockwise to 0 pressure.

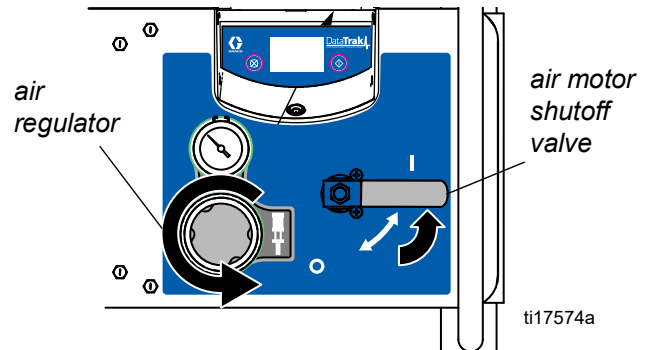

7. Open the air motor shutoff valve.

8. Close the park valve.

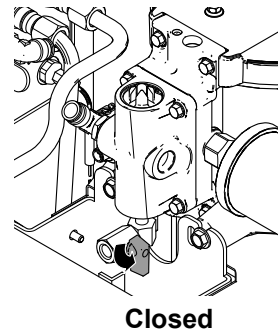

- Slowly increase the air regulator setting until the approximate stall (static) pressure is achieved on fluid gauges (GA) and (GB).

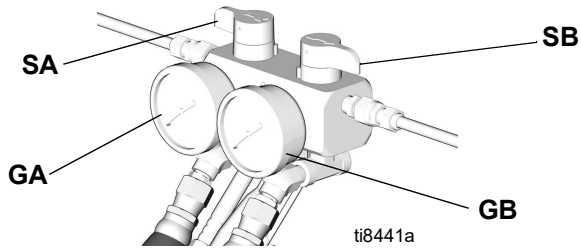

- Check fluid pressure gauges (GA, GB) to ensure proper pressure balance. If imbalanced, reduce pressure of higher component by slightly turning PRESSURE RELIEF/SPRAY valve for that component toward PRESSURE RELIEF/CIRCULATION, until gauges show balanced pressures.

NOTE: Ensure relief tubes are in waste containers.

- Open gun fluid inlet valves A and B.

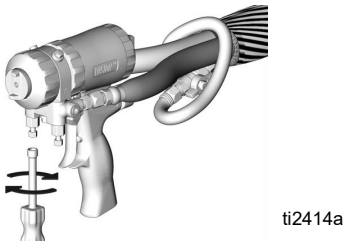

- Disengage gun piston safety lock.



- Test spray onto cardboard. Adjust the air regulator to get the minimum fluid pressure that results in a good spray pattern.

NOTE: Pumps have fluid to air ratio of 25 to 1. Feed pumps add 2X feed pressure boost to outlet pressure (on the up stroke only). For best results, use regulators on feed pumps to limit inlet feed pressure to approximately 100 psi (0.7 MPA, 7 bar).

- Check A and B fluid pressure gauges (GA, GB) to ensure proper pressure balance between A and B.

- Equipment is ready to spray.

Spray Adjustments

Flow rate, atomization, and amount of overspray are affected by four variables.

- Fluid pressure setting.** Too little pressure results in an uneven pattern, coarse droplet size, low flow, and poor mixing. Too much pressure results in excessive overspray, high flow rates, difficult control, and excessive wear.
- Fluid temperature.** Effects are similar to when fluid pressure setting is too high or too low.
- Mix chamber size.** Choice of mix chamber is based on desired flow rate within machine capability and fluid viscosity.
- Cleanoff air adjustment.** Too little cleanoff air results in droplets building up on the front of the nozzle, and no pattern containment to control overspray. Too much cleanoff air results in air-assisted atomization and excessive overspray.

Park

Park the pumps at the end of the day to cycle proportioner pumps to home position, submerging displacement rod.

1. Open the park valve.

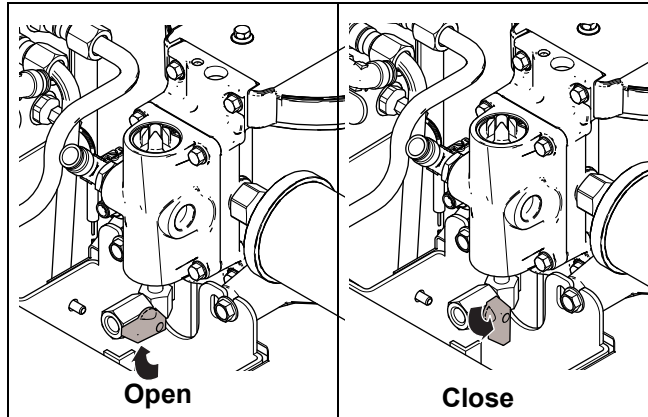

2. Trigger the gun until pumps stop at the bottom and relieve pressure.
3. Close the air motor shutoff valve.
4. Close the park valve.

Pressure Relief Procedure



The Fusion AP gun is shown.

1. Turn off feed pumps and agitator if used.
2. Park component A pump. Follow **Park**, page 27.
3. Close the air inlet valve.
4. Trigger spray gun until gauges read zero.

5. Engage gun piston safety lock.



6. Close gun fluid inlet valves A and B.

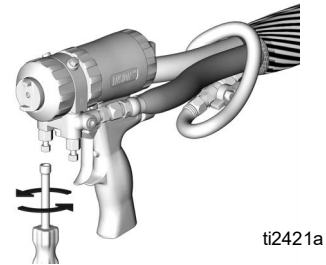

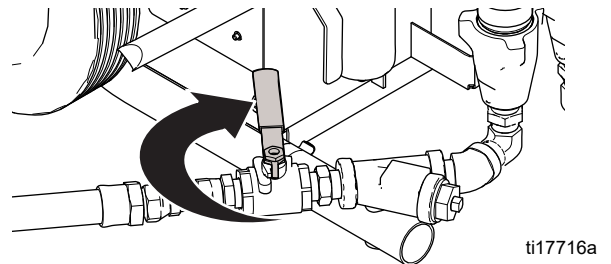

7. Close pump inlet supply valves.



Shutdown

1. Turn main heater power OFF 
2. Follow **Park**, page 27.
3. Check and fill wet-cups (AK, Z).
4. Follow gun shutdown procedure. See gun manual.

Flushing

				
Flush equipment only in a well-ventilated area. Do not spray flammable fluids. Do not turn on heaters while flushing with flammable solvents.				

- Flush out old fluid with new fluid, or flush out old fluid with a compatible moisture-free solvent.
- Use lowest possible pressure when flushing.
- To flush feed hoses, pumps, and the heater separately from the heated hoses, set PRESSURE RELIEF/SPRAY valves (SA, SB) to PRESSURE RELIEF/CIRCULATION. Flush through bleed lines (N).

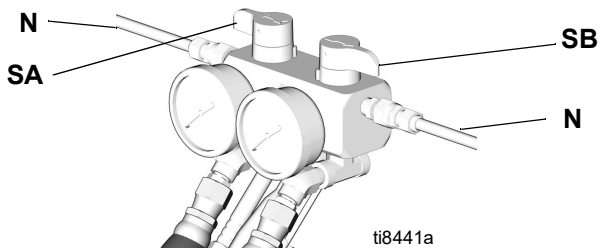

- To flush entire system, circulate through gun fluid manifold (with manifold removed from gun).
- Always leave hydraulic oil or a non-water based, non-water absorbent fluid in system. Do not use water.

				
Only use flush solvents that are compatible with Fluoroelastomer seals. Non-compatible solvents will damage seals and cause hazardous conditions, such as high pressure leaks.				

Operation

Daily Start-up Procedure



The daily start-up procedures describe normal operation. Assume that all temperature and pressure settings have been previously set, but that the heating system is not up to operating temperature.

1. Check condition isocyanate lubrication system and service as required. Change pump lubricant when it shows signs of change to a milky color.
2. Ensure supply fluid is at correct temperature as recommended by chemical system supplier. Ensure individual chemicals are correctly agitated within their drums/day tanks, and moisture protection system is properly set for operation. Recirculate heated fluid back to supply drums if necessary; see **Circulation Through Reactor**, page 31.
3. Turn on main air supply to transfer pumps.
4. Pressurize transfer pumps and open A- and B-inlet supply valves.
5. Open air inlet ball valve (DD).

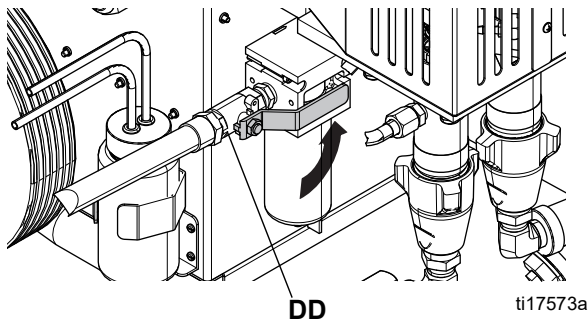

6. Turn main power ON

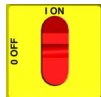

NOTICE

Uncoil heated hoses before turning on hose heater switch to prevent overheating and hot spots within hose.

7. Uncoil heated hose.
8. Check that hose setpoint temperature is correct.
9. Turn on all three heat zones.
10. The hose power controller automatically adjusts the hose current to the hose to compensate for hose length and ambient temperature. Wait for actual hose temperature readout to match hose setpoint temperature.

To prevent excessive pressure build-up in heated hoses, always bring hoses and primary heater up to operating temperature before opening air motor shutoff valve.

11. Set PRESSURE RELIEF/SPRAY valves (SA, SB) to SPRAY.

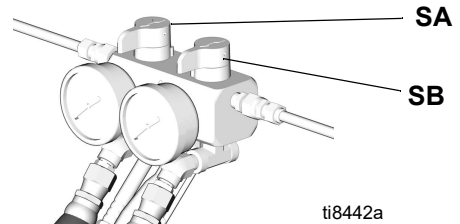

12. Check that heat zones are on and temperatures are on target, see **Set Temperatures**, page 23.
13. Open air motor shutoff valve.
14. Pumps will pressurize the fluid according to air regulator pressure.

Operation

15. Check A and B fluid pressure gauges (GA, GB) to ensure proper pressure balance between A and B. If imbalanced, bleed off the high side with valves SA and SB until balanced.

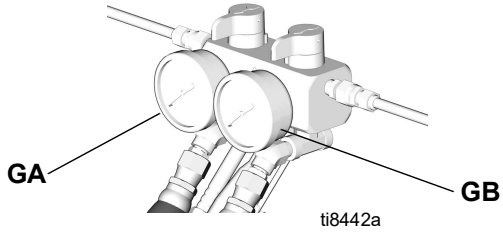

16. Open gun fluid manifold valves A and B.

The Fusion AP gun is shown.

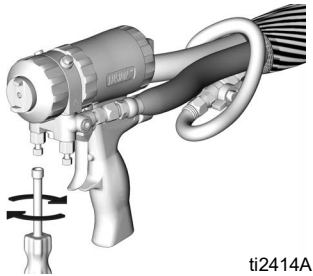

17. Disengage gun piston safety lock.



18. Test spray onto cardboard.

19. Equipment is ready to spray.

Fluid Circulation

Circulation Through Reactor

Do not circulate fluid containing a blowing agent without consulting with your material supplier regarding fluid temperature limits.				

To circulate through gun manifold and preheat hose, see **Circulation Through Gun Manifold**, page 32.

1. Follow **Initial Startup**, page 22.

Do not install shutoffs downstream of the PRESSURE RELIEF/SPRAY valve outlets (BA, BB). The valves function as overpressure relief valves when set to SPRAY . Lines must be open so valves can automatically relieve pressure when machine is operating.				

2. See **Typical Installation, with Circulation**, page 11. Route circulation lines back to respective component A or B supply drum. Use hoses rated at the maximum working pressure of this equipment. See **Technical Specifications**, page 38.
3. Set PRESSURE RELIEF/SPRAY valves (SA, SB) to

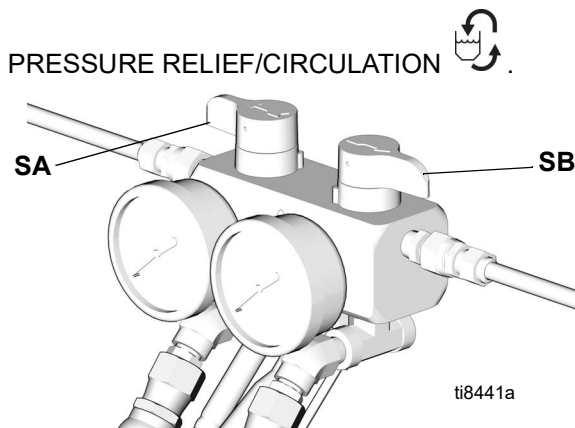



4. Turn main power ON

5. Set temperature targets, see **Set Temperatures**, page 23. Turn on **A** and **B** heat zones by pressing . **Do not** turn on heat zone unless hoses are already loaded with fluid.
6. Press to display actual temperatures.
7. Turn the air regulator to a low pressure until **A** and **B** temperatures reach targets. Increase the pressure once the temperatures are on target.

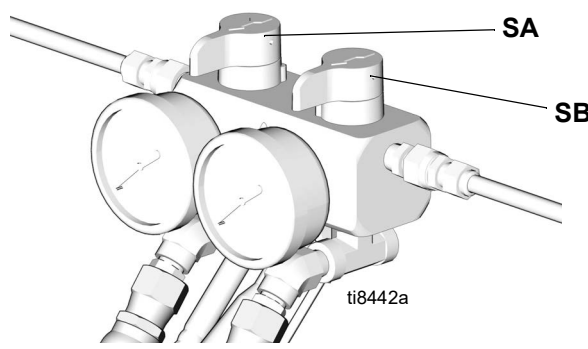
8. Turn on heat zone by pressing .
9. Set PRESSURE RELIEF/SPRAY valves (SA, SB) to SPRAY .



Circulation Through Gun Manifold

				
Do not circulate fluid containing a blowing agent without consulting with your material supplier regarding fluid temperature limits.				

Circulating fluid through the gun manifold allows rapid preheating of hose.

1. Install gun fluid manifold (P) on accessory circulation kit (CK). Connect high pressure circulation lines (R) to circulation manifold.

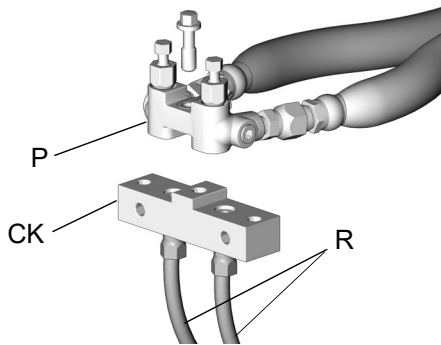

ti2767a





The Fusion AP gun manifold is shown.

Table 1: Circulation Kit (CK)



Part	Gun	Manual
246362	Fusion AP	309818
256566	Fusion CS	313058

2. Route circulation lines back to respective component A or B supply drum. Use hoses rated at the maximum working pressure of this equipment. See manual for installation instructions.
3. Follow **Initial Startup**, page 22.

4. Turn main power ON .

5. Set temperature targets, see **Set Temperatures**, page 23. Turn on , , and  heat zones by pressing .

6. Press  to display actual temperatures.

7. Turn the air regulator to a low pressure until  and  temperatures reach targets. Increase the pressure once the temperatures are on target.

DataTrak Controls and Indicators

The DataTrak on the Reactor A-25 sprayers do not have runaway protection. For setup and operation instructions see **DataTrak Operation**, page 34.

Key for FIG. 4

AB Combined Lower Displacement (user settable)

AC Flow Rate Units (user settable to \updownarrow /min, gpm [US], gpm [Imperial], oz/min [US], oz/min [Imperial], l/min, or cc/min)

AD LED (fault indicator when lit)

AE Display

PF Prime/Flush Key (Enables Prime/Flush mode. While in Prime/Flush mode, the batch totalizer [BT] will not count.) LED will flash while in Prime/Flush mode.

RK Reset Key (Resets faults. Press and hold for 3 seconds to clear the batch totalizer.) Push to toggle between flow rate and cycle rate.

CF Cycle/Flow Rate

BT Batch Totalizer

GT Grand Totalizer

RT Runaway Toggle (leave disabled)

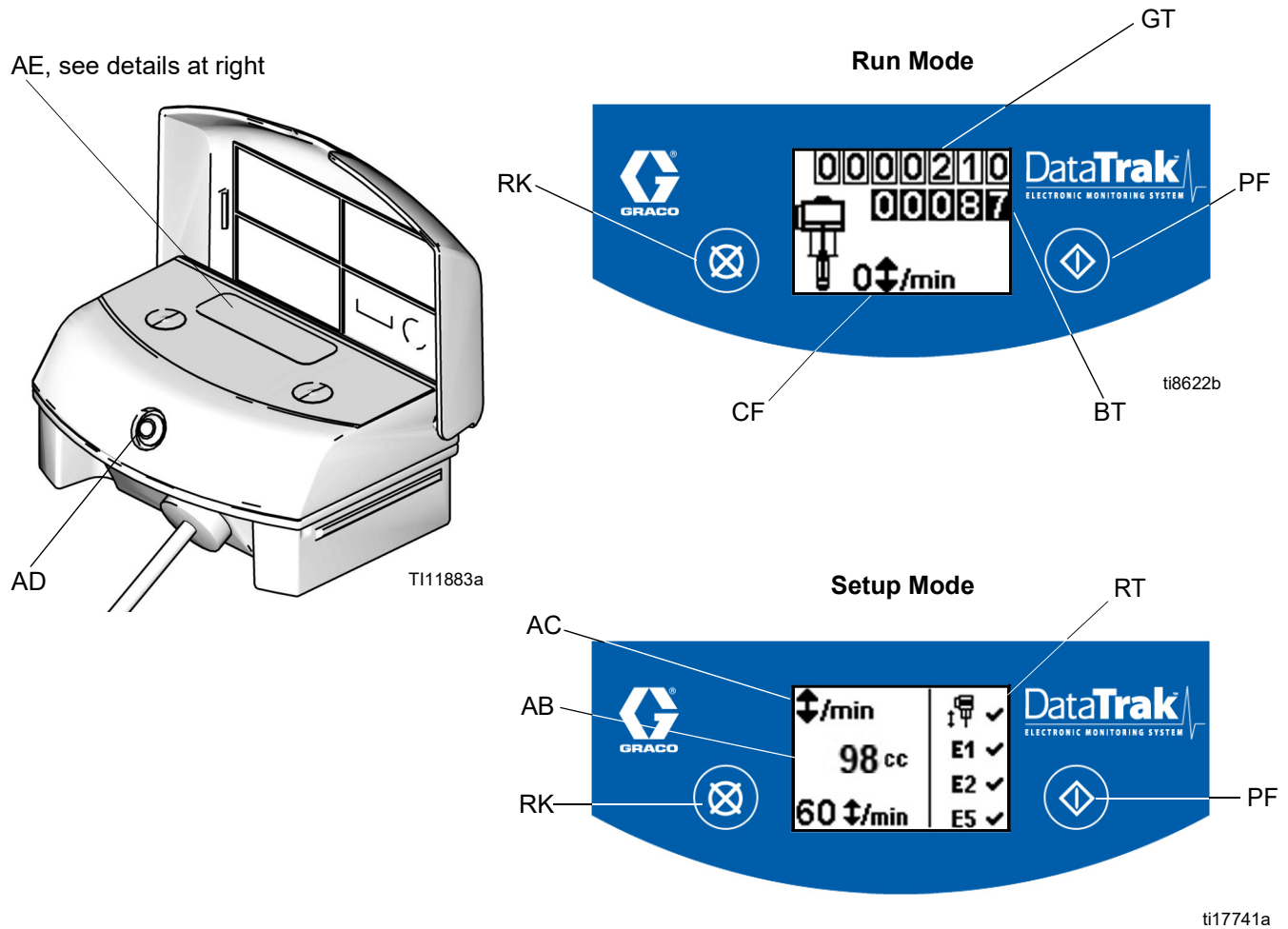

FIG. 4. DataTrak Controls and Indicators





DataTrak Operation

The display (AE) will turn off after 1 minute to save battery life. Press any key to wake up the display.

NOTICE

To prevent damage to the soft key buttons, do not press the buttons with sharp objects such as pens, plastic cards, or fingernails.

Setup Mode

1. See FIG. 4, page 33. Press and hold  for 5 seconds until Setup menu appears.
2. To enter settings for lower size, flow rate units, and disable runaway protection press  to change the value, then  to save the value and move the cursor to the next data field.
 - Set lower size to 98cc.
 - Disable runaway.
3. Move the cursor to the E5 error enable option field, then press  once more to exit Setup mode.

Run Mode

Prime/Flush

1. See FIG. 4, page 33. To enter Prime/Flush mode, press any key to wake up the display, then press . The Prime/Flush symbol will appear in the

display and the LED will flash

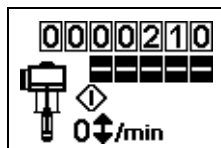

2. While in Prime/Flush mode, the batch totalizer (BT) will not count. The grand totalizer (GT) continues to count.
3. To exit Prime/Flush mode, press any key to wake up the display, then press . The Prime/Flush symbol will disappear from the display and the LED will stop flashing.

Counter/Totalizer

See FIG. 4, page 33. The last digit of the batch totalizer (BT) represents tenths of gallons or liters. To reset the totalizer, press any key to wake up the display, then press and hold  for 3 seconds.

- If AC is set to gallons or ounces, BT and GT display gallons.
- If AC is set to liters or cc, BT and GT display liters.
- If AC is set to cycles, BT and GT display cycles.

Press  to toggle between flow rate units and cycles. A letter under the BT display indicates that both BT and GT are displaying gallons (g) or liters (l). No letter means both BT and GT are displaying cycles.

Display

See FIG. 4, page 33. The display (AE) will turn off after 1 minute of inactivity in Run mode or 3 minutes in Setup mode. Press any key to wake up the display.

DataTrak will continue to count cycles when display is off.

The display (AE) may turn off if a high-level static discharge is applied to the DataTrak. Press any key to wake up the display.

Diagnostics

See **DataTrak Diagnostic Codes**, page 36.

Maintenance

- Check and add TSL to B side pump wet-cup daily.
- Check ISO lube bottle for significant discoloration or crystallization daily. Replace with fresh TSL when needed.
- Ensure ISO (A) pump is down and in PARK position during every shutdown.
- Keep any ISO (A) fluid from being exposed to atmosphere to prevent crystallization.
- Remove inlet filter screen plug (V, Y) and clean screens if increased unbalanced pressures between A and B is noticed or as needed for fluids used. Also clean after flushing.
- Close gun fluid shutoff valves when not in use.
- If using a Fusion AP or Probler P2 gun, add grease with grease gun per manual.
- Clean gun filter screens and mix chamber ports regularly, or when increased unbalanced pressures between A and B is noticed. See gun manual.
- Use lithium grease or Iso Pump Oil on all threaded fluid fittings on the “A” side.



Diagnostic Codes

Temperature Control Diagnostic Codes

Temperature control diagnostic codes appear on temperature display.

These alarms turn off heat. E99 clears automatically when communication is regained. Codes E03 through

E06 can be cleared by pressing . For other codes,

turn main power OFF  then ON  to clear.

See repair manual for corrective action.



Code	Code Name	Alarm Zone
01	High fluid temperature	Individual
02	High zone current	Individual
03	No zone current	Individual
04	FTS or thermocouple disconnected	Individual
05	Control board over temperature	Individual
06	Communication cable unplugged	Individual
30	Momentary loss of communication	All
99	Loss of communication	All

For hose zone only, if FTS is disconnected at startup, display will show hose current 0A.

DataTrak Diagnostic Codes

DataTrak can diagnose several problems with the pump. When the monitor detects a problem, the LED (AD, FIG. 4) will flash and a diagnostic code will appear on the display.

To acknowledge the diagnosis and return to the normal operating screen, press  once to wake up the display, and once more to clear the diagnostic code screen.

Symbol	Code	Code Name	Diagnosis	Cause
 E2	E-2	Diving Down	Leak during downstroke.	Worn intake valve.
 E3	E-3	Low Battery	Battery voltage too low to stop runaway.	Low battery. Replace battery; see Reactor A-25 Repair manual.
 E6 Fuse 250mA	E-6	Blown Fuse	Fuse is blown. Replace fuse; see Reactor A-25 Repair manual.	<ul style="list-style-type: none"> Faulty solenoid or solenoid wiring. Extreme temperatures (above 140°F [60°C]).

Dimensions

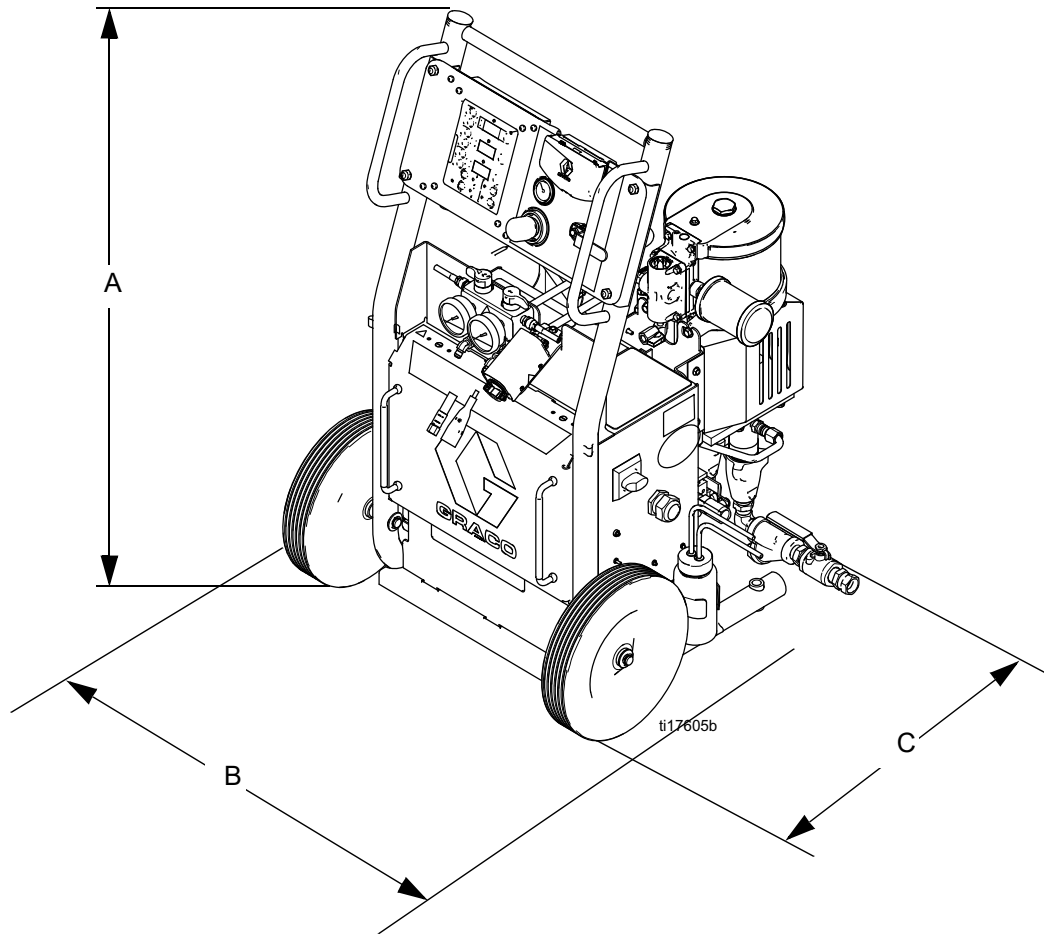

	With Wheels	Without Wheels
Dimension	in. (mm)	in. (mm)
A	43.5 (1105)	43.5 (1105)
B	29 (736.6)	21.5 (546)
C	30 (762)	24.5 (622)

Technical Specifications

Category	Data	
	A-25	A-XP1
Maximum Fluid Working Pressure	2000 psi (14 MPa, 138 bar)	3500 psi (24 MPa, 241 bar)
Maximum Air Supply Pressure	125 psi (0.9 MPa, 9 bar)	125 psi (0.9 MPa, 9 bar)
Maximum Air Working Pressure	80 psi (550 kPa, 5.5 bar)	100 psi (689 MPa, 6.9 bar)
Pressure Ratio	25:1	35:1
Air consumption	28 scfm (0.8m ³ /min) 02 tip at 1500 psi stall pressure	32 scfm (0.9 m ³ /min) 00 tip at 2000 psi stall pressure
Machine Maximum Power with hose	9000 watts	13,000 watts
Voltage Tolerance Range (50/60 Hz):		
200-240 V ac Nominal, 1-Phase	195-253 V ac	
200-240 V ac Nominal, 3-Phase Delta	195-253 V ac	
350-415 V ac Nominal, 3-Phase Wye (200-240 V ac Line-to-Neutral)	338-457 V ac	
Amperage Requirement (Full Load Peak)*	40 amps @ 230 V ac, 1-Phase 32 amps @ 230 V ac, 3-Phase 18.5 amps @ 380 V ac, 3-Phase	56 amps @ 230 V ac, 1-Phase 45 amps @ 230 V ac, 3-Phase 26 amps @ 380 V ac, 3-Phase
Maximum Heater Fluid Temperature	190 °F (88 °C)	
Maximum Hose Fluid Temperature	180 °F (82 °C)	
Maximum Ambient Temperature	120 °F (49 °C)	
Maximum Output	25 lb/min. (11.4 kg/min.)	1.5 gal/min. at 2000 psi
Output Per Cycle (A and B)	0.025 gal/cycle (0.095 ltr/cycle)	0.017 gal/cycle (0.094 ltr/cycle)
Heater Power	6000 watts	10,200 watts
Hose Power	2790 watts	
Sound Pressure (see NXT air motor manual)	70.2 dB(A)	
Sound Power (see NXT air motor manual)	80.1 dB(A)	
Viscosity Range	250-1500 centipoise (typical)	
Maximum Fluid Inlet Pressure	300 psi (2.1 MPa, 21 bar) or 15% of output pressure	
Fluid Inlet/Strainer Filter	20 mesh standard	
Air inlet Filter Mesh	40 Micron	
Component B (Resin) Inlet	3/4 npt(f) swivel	
Component A (Isocyanate) Inlet	3/4 npt(f) swivel	
Recirculation/Block Hose Connections	Iso (A) side: #5 JIC (m); Resin (B) side: #6 JIC (m)	
Maximum Heated Hose Length***	210 ft of 3/8 ID	
Weight	310 lb (140.6 kg)	
Wetted Parts	Carbon steel, stainless steel, chrome, aluminum, Fluoroelastomer, PTFE, nylon	

*Full load amps with all devices operating at maximum capabilities with 210 ft (64.1 m) of hose.

***210 ft (64 m) of heated hose will produce the maximum allowable heat capacity. 310 ft (94 m) of heated hose may be used, but will have 25% less heat capacity.

California Proposition 65

CALIFORNIA RESIDENTS

 **WARNING:** Cancer and reproductive harm – www.P65warnings.ca.gov.

Graco Standard Warranty

Graco warrants all equipment referenced in this document which is manufactured by Graco and bearing its name to be free from defects in material and workmanship on the date of sale to the original purchaser for use. With the exception of any special, extended, or limited warranty published by Graco, Graco will, for a period of twelve months from the date of sale, repair or replace any part of the equipment determined by Graco to be defective. This warranty applies only when the equipment is installed, operated and maintained in accordance with Graco's written recommendations.

This warranty does not cover, and Graco shall not be liable for general wear and tear, or any malfunction, damage or wear caused by faulty installation, misapplication, abrasion, corrosion, inadequate or improper maintenance, negligence, accident, tampering, or substitution of non-Graco component parts. Nor shall Graco be liable for malfunction, damage or wear caused by the incompatibility of Graco equipment with structures, accessories, equipment or materials not supplied by Graco, or the improper design, manufacture, installation, operation or maintenance of structures, accessories, equipment or materials not supplied by Graco.

This warranty is conditioned upon the prepaid return of the equipment claimed to be defective to an authorized Graco distributor for verification of the claimed defect. If the claimed defect is verified, Graco will repair or replace free of charge any defective parts. The equipment will be returned to the original purchaser transportation prepaid. If inspection of the equipment does not disclose any defect in material or workmanship, repairs will be made at a reasonable charge, which charges may include the costs of parts, labor, and transportation.

THIS WARRANTY IS EXCLUSIVE, AND IS IN LIEU OF ANY OTHER WARRANTIES, EXPRESS OR IMPLIED, INCLUDING BUT NOT LIMITED TO WARRANTY OF MERCHANTABILITY OR WARRANTY OF FITNESS FOR A PARTICULAR PURPOSE.

Graco's sole obligation and buyer's sole remedy for any breach of warranty shall be as set forth above. The buyer agrees that no other remedy (including, but not limited to, incidental or consequential damages for lost profits, lost sales, injury to person or property, or any other incidental or consequential loss) shall be available. Any action for breach of warranty must be brought within two (2) years of the date of sale.

GRACO MAKES NO WARRANTY, AND DISCLAIMS ALL IMPLIED WARRANTIES OF MERCHANTABILITY AND FITNESS FOR A PARTICULAR PURPOSE, IN CONNECTION WITH ACCESSORIES, EQUIPMENT, MATERIALS OR COMPONENTS SOLD BUT NOT MANUFACTURED BY GRACO. These items sold, but not manufactured by Graco (such as electric motors, switches, hose, etc.), are subject to the warranty, if any, of their manufacturer. Graco will provide purchaser with reasonable assistance in making any claim for breach of these warranties.

In no event will Graco be liable for indirect, incidental, special or consequential damages resulting from Graco supplying equipment hereunder, or the furnishing, performance, or use of any products or other goods sold hereto, whether due to a breach of contract, breach of warranty, the negligence of Graco, or otherwise.

FOR GRACO CANADA CUSTOMERS

The Parties acknowledge that they have required that the present document, as well as all documents, notices and legal proceedings entered into, given or instituted pursuant hereto or relating directly or indirectly hereto, be drawn up in English. Les parties reconnaissent avoir convenu que la rédaction du présente document sera en Anglais, ainsi que tous documents, avis et procédures judiciaires exécutés, donnés ou intentés, à la suite de ou en rapport, directement ou indirectement, avec les procédures concernées.

Graco Information

For the latest information about Graco products, visit www.graco.com.

For patent information, see www.graco.com/patents.

TO PLACE AN ORDER, contact your Graco distributor or call to identify the nearest distributor.

Phone: 612-623-6921 **or Toll Free:** 1-800-328-0211, **Fax:** 612-378-3505

All written and visual data contained in this document reflects the latest product information available at the time of publication. Graco reserves the right to make changes at any time without notice.

Original instructions. This manual contains English. MM 3A1569

Graco Headquarters: Minneapolis

International Offices: Belgium, China, Japan, Korea

GRACO INC. AND SUBSIDIARIES • P.O. BOX 1441 • MINNEAPOLIS MN 55440-1441 • USA
Copyright 2020, Graco Inc. All Graco manufacturing locations are registered to ISO 9001.

www.graco.com

Revision K, January 2023