



## E-Flo® DC Motor

3A2526T  
EN

Electric drive for low to medium volume paint circulation pumps.  
For professional use only.



### **Important Safety Instructions**

Read all warnings and instructions in this manual. Save these instructions.

*See page 3 for model part numbers and approvals information.*

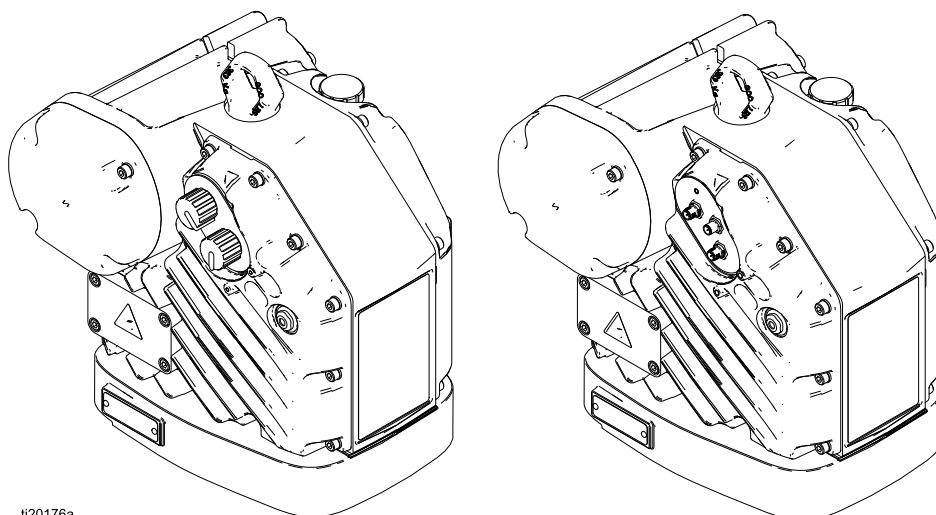

ti20176a

# Contents

Related Manuals .....	2	Shutdown .....	13
Models .....	3	Pressure Relief Procedure .....	13
Basic Models .....	3	Advanced Motor Operation .....	13
Basic Models with Region-Specific Approvals .....	4	Basic Motor Operation .....	14
Advanced Models .....	5	Maintenance .....	16
Advanced Models with Region-Specific Approvals .....	6	Preventive Maintenance Schedule .....	16
Warnings .....	7	Change the Oil .....	16
Installation .....	10	Check the Oil Level .....	16
Check the Oil Level Before Using the Equipment .....	10	Error Code Troubleshooting .....	17
Power Supply Requirements .....	10	Accessories .....	18
Connect the Power Supply .....	11	Appendix A - System Control Drawing 24N637 .....	19
Grounding .....	12	Dimensions and Mounting Holes .....	24
Intrinsically Safe Installation Requirements for Advanced Motors .....	12	E-Flo DC Motor Dimensions .....	24
Operation .....	13	Mounting Hole Pattern .....	24
Startup .....	13	Technical Data .....	25

## Related Manuals

Manual No.	Description
3A4801	E-Flo DC Repair–Parts
3A2527	Advanced Control Module Instructions–Parts

# Models

## Basic Models

Motor Part No.	Series	Horsepower	Maximum Force, lbf (N)
EM0011	C	1	1400 (6227)
EM0021	C	2	2800 (12455)



**Ex** II 2 G  
 Ex db IIA T6 Gb 0°C ≤ Ta ≤ 40°C  
 FM12ATEX0067X  
 FM21UKEX0205X  
 IECEx FMG 12.0028X

**FM** APPROVED For Class I, Div. 1, Group D T6.  
 Class 1, Zone 1, AEx db IIA T6 0°C ≤ Ta ≤ 40°C  
 Ex d IIA T6 Gb 0°C ≤ Ta ≤ 40°C

**E-Flo® DC Motor**

**GRACO INC.**  
 P.O. Box 1441  
 Minneapolis, MN  
 55440 U.S.A.

**PART NO. SERIES NO. MFG. YR. SERIAL NO.**

VOLTS	Um: 250 V	kVA	Hz
			50/60

**CE** 2575

**Ex** II 2 G  
 Ex db IIA T6 Gb  
 0°C ≤ Ta ≤ 40°C  
 FM12ATEX0067X  
 FM21UKEX0205X  
 IECEx FMG 12.0028X

**UK CA** 0359  
 Explosion proof. For Class I, Div 1, Group D T6.  
 Class 1, Zone 1, AEx db IIA T6 0°C ≤ Ta ≤ 40°C  
 Ex d IIA T6 Gb 0°C ≤ Ta ≤ 40°C  
 Use cables rated 70°C minimum.  
 Conduit seal required within 18 inches for  
 US and Canada.

**FM** APPROVED

16T557k

Figure 1 Basic Motor Identification Label

### List of Standards

- IEC 60079-0: 2017 (Ed. 7)
- IEC 60079-1: 2014 (Ed. 7)
- EN IEC 60079-0: 2018
- EN 60079-1: 2014 (Ed. 7)
- ANSI/ISA 60079-0: 2013
- ANSI/ISA 60079-1: 2015
- FM 3615:2018
- CSA C22.2 No. 0.4:2017
- CSA C22.2 No. 0.5:2016
- CSA C22.2 No. 30:R2016
- CSA-C22.2 No. 60079-0:2015
- CSA-C22.2 No. 60079-1:2016
- CAN/CSA C22.2 No. 61010.1:R2017

### Specific Conditions of Use:

1. Consult the manufacturer if dimensional information on the flameproof joint is necessary.
2. Consult the manufacturer for genuine replacement fasteners. M8 x 30 socket-head cap screws of Class 12.9 steel or better with a minimum yield strength of 1100 MPa (160,000 psi) are acceptable alternatives.

### Basic Models with Region-Specific Approvals

Motor Part No.	Series	Horsepower	Maximum Force, lbf (N)
EM0013	C	1	1400 (6227)
EM0023	C	2	2800 (12455)

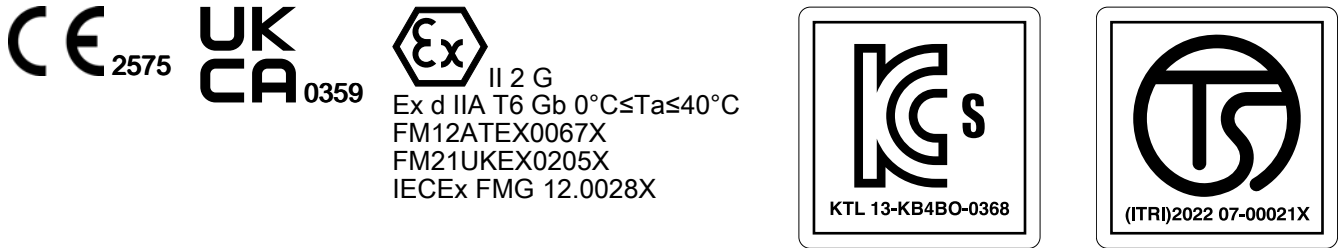

All Models



Model EM0013

Model EM0023

**E-Flo® DC Motor**

PART NO.	SERIES NO.	MFG. YR.	SERIAL NO.	VOLTS	Um: 250 V	kVA	Hz
部品番号	シリーズ NO.	MFG. 年月	シリアル NO.	電圧(V)			
零件号	系列号	制造年份	序列号	电压			50/60

**Use cables rated 70°C minimum.**

全てのケーブルは70°Cの定格である必要があります。  
使用最低额定温度为70°C的电缆。

**Ex d IIA T4 Gb, 2021322301003946**

**Ex db IIA T6 Gb**  
0°C ≤ Ta ≤ 40°C  
FM12ATEX0067X  
FM21UKEX0205X  
IECEx FMG 12.0028X

**GRACO INC.**  
P.O. Box 1441  
Minneapolis, MN  
55440 U.S.A.

16W333g

Figure 2 Basic Motor with Region-Specific Approvals Identification Label

**List of Standards**

- IEC 60079-0: 2017 (Ed. 7)
- IEC 60079-1: 2014 (Ed. 7)
- EN IEC 60079-0: 2018
- EN 60079-1: 2014 (Ed. 7)

**Specific Conditions of Use:**

1. Consult the manufacturer if dimensional information on the flameproof joint is necessary.
2. Consult the manufacturer for genuine replacement fasteners. M8 x 30 socket-head cap screws of Class 12.9 steel or better with a minimum yield strength of 1100 MPa (160,000 psi) are acceptable alternatives.

## Advanced Models

Motor Part No.	Series	Horsepower	Maximum Force, lbf (N)
EM0012	C	1	1400 (6227)
EM0015	C	1	1400 (6227)
EM0022	C	2	2800 (12455)
EM0025	C	2	2800 (12455)



II 2 (1) G  
 Ex db [ia Ga] IIA T6 Gb 0°C ≤ Ta ≤ 40°C  
 FM12ATEX0067X  
 FM21UKEX0205X  
 IECEx FMG 12.0028X



APPROVED For Class I, Div. 1, Group D T6.  
 Class 1, Zone 1, AEx db [ia] IIA T6 0°C ≤ Ta ≤ 40°C  
 Ex db [ia] IIA T6 0°C ≤ Ta ≤ 40°C

GRACO INC.  
 P.O. Box 1441  
 Minneapolis, MN  
 55440 U.S.A.

### E-Flo® DC Motor

PART NO.	SERIES NO.	MFG. YR.	SERIAL NO.

VOLTS	Um: 250 V	kVA	Hz
			50/60

16T5561

II 2 (1) G  
 Ex db [ia Ga] IIA T6 Gb  
 0°C ≤ Ta ≤ 40°C  
 FM12ATEX0067X  
 FM21UKEX0205X  
 IECEx FMG 12.0028X

Explosion proof with intrinsically safe connections.  
 For Class I, Div 1, Group D T6. Install per 24N637.  
 Class 1, Zone 1, AEx db [ia] IIA T6 0°C ≤ Ta ≤ 40°C  
 Ex db [ia] IIA T6 0°C ≤ Ta ≤ 40°C  
 Use cables rated 70°C minimum.  
 Conduit seal required within 18 inches for US and Canada.

Figure 3 Advanced Motor Identification Label

### List of Standards

- IEC 60079-0: 2017 (Ed. 7)
- IEC 60079-1: 2014 (Ed. 7)
- IEC 60079-11: 2011 (Ed. 6)
- EN IEC 60079-0: 2018
- EN 60079-1: 2014 (Ed. 7)
- EN 60079-11: 2012
- FM 3600:2018
- FM 3610:2018
- FM 3615:2018
- FM 3810:2018
- CSA C22.2 No. 0.4:2017
- CSA C22.2 No. 0.5:2016
- CSA C22.2 No. 30:R2016
- CSA C22.2 No. 157:R2016
- CSA-C22.2 No. 60079-0:2015
- CSA-C22.2 No. 60079-1:2016
- CAN/CSA C22.2 No. 61010-1:R2017
- CAN/CSA-E60079-11:2011
- ANSI/ISA 60079-0:2013
- ANSI/ISA 60079-1:2015
- ANSI/ISA 60079-11:2011

### Specific Conditions of Use:

1. Consult the manufacturer if dimensional information on the flameproof joint is necessary.
2. Consult the manufacturer for genuine replacement fasteners. M8 x 30 socket-head cap screws of Class 12.9 steel or better with a minimum yield strength of 1100 MPa (160,000 psi) are acceptable alternatives.

### Advanced Models with Region-Specific Approvals

Motor Part No.	Series	Horsepower	Maximum Force, lbf (N)
EM0014	C	1	1400 (6227)
EM0016	C	1	1400 (6227)
EM0024	C	2	2800 (12455)
EM0026	C	2	2800 (12455)

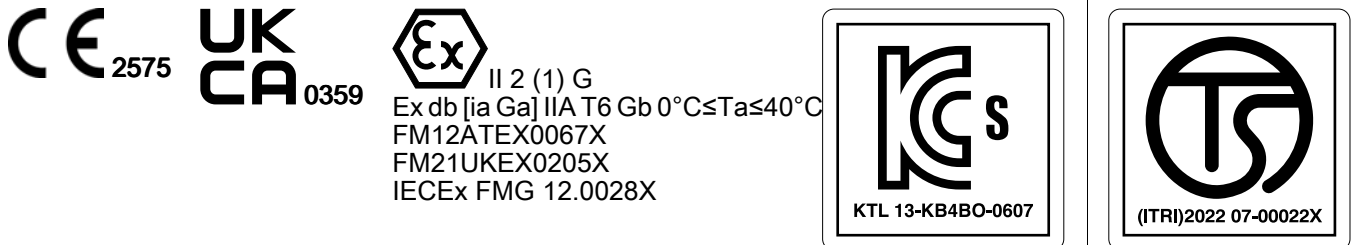

All Models

Models EM0014, EM0022, EM0024



Model EM0014



Model EM0024



Model EM0026

**E-Flo® DC Motor**

PART NO. 零件号	SERIES NO. 系列号	MFG. YR. 制造年份	SERIAL NO. 序列号	VOLTS 电压	Um: 250 V	kVA	Hz
							50/60

Use cables rated 70°C minimum.  
使用最低额定温度为70°C的电缆。

Ex d [ia Ga] IIA T6 Gb, 2021322301003985

Ex db [ia Ga] IIA T6 Gb  
0°C ≤ Ta ≤ 40°C  
FM12ATEX0067X  
FM21UKEX0205X  
IECEx FMG 12.0028X

GRACO INC.  
P.O. Box 1441  
Minneapolis, MN  
55440 U.S.A.

16W334h

Figure 4 Advanced Motor with Region-Specific Approvals Identification Label

**List of Standards**







- IEC 60079-0: 2017 (Ed. 7)
- IEC 60079-1: 2014 (Ed. 7)
- IEC 60079-11: 2011 (Ed. 6)
- EN IEC 60079-0: 2018
- EN 60079-1: 2014 (Ed. 7)
- EN 60079-11: 2012





**Specific Conditions of Use:**

1. Consult the manufacturer if dimensional information on the flameproof joint is necessary.
2. Consult the manufacturer for genuine replacement fasteners. M8 x 30 socket-head cap screws of Class 12.9 steel or better with a minimum yield strength of 1100 MPa (160,000 psi) are acceptable alternatives.

# Warnings

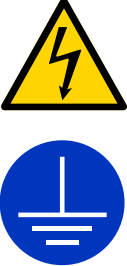
The following warnings are for the setup, use, grounding, maintenance, and repair of this equipment. The exclamation point symbol alerts you to a general warning and the hazard symbols refer to procedure-specific risks. When these symbols appear in the body of this manual or on warning labels, refer back to these warnings. Product-specific hazard symbols and warnings not covered in this section may appear throughout the body of this manual where applicable.







 <span style="font-size: 2em; font-weight: bold; margin-left: 10px;">WARNING</span>	
    	<p><b>FIRE AND EXPLOSION HAZARD</b></p> <p>Flammable fumes, such as solvent and paint fumes, in work area can ignite or explode. To help prevent fire and explosion:</p> <ul style="list-style-type: none"> <li>• Use equipment only in well-ventilated area.</li> <li>• Eliminate all ignition sources; such as pilot lights, cigarettes, portable electric lamps, and plastic drop cloths (potential static sparking).</li> <li>• Ground all equipment in the work area. See <b>Grounding</b> instructions.</li> <li>• Keep work area free of debris, including solvent, rags, and gasoline.</li> <li>• Do not plug or unplug power cords, or turn power or light switches on or off when flammable fumes are present.</li> <li>• Use only grounded hoses.</li> <li>• Hold gun firmly to side of grounded pail when triggering into pail. Do not use pail liners unless they are antistatic or conductive.</li> <li>• <b>Stop operation immediately</b> if static sparking occurs or you feel a shock. Do not use equipment until you identify and correct the problem.</li> <li>• Keep a working fire extinguisher in the work area.</li> </ul> <p>Static charge may build up on plastic parts during cleaning and could discharge and ignite flammable vapors. To help prevent fire and explosion:</p> <ul style="list-style-type: none"> <li>• Clean plastic parts only in well-ventilated area.</li> <li>• Do not clean with a dry cloth.</li> <li>• Do not operate electrostatic guns in equipment work area.</li> </ul>
	<p><b>SPECIAL CONDITIONS FOR SAFE USE</b></p> <ul style="list-style-type: none"> <li>• Consult the manufacturer if dimensional information on the flameproof joints is necessary.</li> <li>• Consult the manufacturer for genuine replacement terminal compartment/wiring entry and enclosure fasteners. M8x30 socket headed cap screws of Class 12.9 steel or better with a minimum yield strength of 1100 MPa (160,000 psi) are acceptable alternatives.</li> </ul>

 <h1 style="margin: 0;">WARNING</h1>	
	<p><b>ELECTRIC SHOCK HAZARD</b></p> <p>This equipment must be grounded. Improper grounding, setup, or usage of the system can cause electric shock.</p> <ul style="list-style-type: none"> <li>• Turn off and disconnect power at main switch before disconnecting any cables and before servicing or installing equipment.</li> <li>• Connect only to grounded power source.</li> <li>• All electrical wiring must be done by a qualified electrician and comply with all local codes and regulations.</li> </ul>
	<p><b>INTRINSIC SAFETY</b></p> <p>Intrinsically safe equipment that is installed improperly or connected to non-intrinsically safe equipment will create a hazardous condition and can cause fire, explosion, or electric shock. Follow local regulations and the following safety requirements.</p> <ul style="list-style-type: none"> <li>• Be sure your installation complies with national, state, and local codes for the installation of electrical apparatus in a Class I, Group D, Division 1 Hazardous Location, including all of the local safety fire codes, NFPA 33, NEC 500 and 516, and OSHA 1910.107.</li> <li>• Equipment that comes in contact with the equipment's intrinsically safe terminals must meet the entity parameter requirements specified in Control Drawing 24N637. See <a href="#">Intrinsically Safe Installation Requirements for Advanced Motors, page 12</a>. This includes safety barriers, DC voltage meters, ohmmeters, cables, and connections. Remove the unit from the hazardous area when troubleshooting.</li> <li>• Do not install any equipment approved only for a non-hazardous location in a hazardous area, as defined in Article 500 of the National Electrical Code (USA) or your local electrical code. See the ID label for the intrinsic safety rating for your equipment.</li> <li>• Ground the motor. Use a 12 gauge minimum ground wire, connected to a true earth ground. See <a href="#">Grounding, page 12</a>.</li> <li>• Do not operate the motor with any cover removed.</li> <li>• Do not substitute system components, as this may impair intrinsic safety.</li> </ul>
	<p><b>BURN HAZARD</b></p> <p>Equipment surfaces and fluid that is heated can become very hot during operation. To avoid severe burns:</p> <ul style="list-style-type: none"> <li>• Do not touch hot fluid or equipment.</li> </ul>
	<p><b>MOVING PARTS HAZARD</b></p> <p>Moving parts can pinch, cut, or amputate fingers and other body parts.</p> <ul style="list-style-type: none"> <li>• Keep clear of moving parts.</li> <li>• Do not operate equipment with protective guards or covers removed.</li> <li>• Pressurized equipment can start without warning. Before checking, moving, or servicing equipment, follow the <b>Pressure Relief Procedure</b> and disconnect all power sources.</li> </ul>





# WARNING

 	<p><b>PRESSURIZED EQUIPMENT HAZARD</b></p> <p>Fluid from the equipment, leaks, or ruptured components can splash in the eyes or on skin and cause serious injury.</p> <ul style="list-style-type: none"> <li>• Follow the <b>Pressure Relief Procedure</b> when you stop spraying/dispensing and before cleaning, checking, or servicing equipment.</li> <li>• Tighten all fluid connections before operating the equipment.</li> <li>• Check hoses, tubes, and couplings daily. Replace worn or damaged parts immediately.</li> </ul>
	<p><b>TOXIC FLUID OR FUMES HAZARD</b></p> <p>Toxic fluids or fumes can cause serious injury or death if splashed in the eyes or on skin, inhaled, or swallowed.</p> <ul style="list-style-type: none"> <li>• Read Safety Data Sheets (SDSs) to know the specific hazards of the fluids you are using.</li> <li>• Store hazardous fluid in approved containers, and dispose of it according to applicable guidelines.</li> </ul>
	<p><b>PERSONAL PROTECTIVE EQUIPMENT</b></p> <p>Wear appropriate protective equipment when in the work area to help prevent serious injury, including eye injury, hearing loss, inhalation of toxic fumes, and burns. Protective equipment includes but is not limited to:</p> <ul style="list-style-type: none"> <li>• Protective eyewear, and hearing protection.</li> <li>• Respirators, protective clothing, and gloves as recommended by the fluid and solvent manufacturer.</li> </ul>
 	<p><b>EQUIPMENT MISUSE HAZARD</b></p> <p>Misuse can cause death or serious injury.</p> <ul style="list-style-type: none"> <li>• Do not operate the unit when fatigued or under the influence of drugs or alcohol.</li> <li>• Do not exceed the maximum working pressure or temperature rating of the lowest rated system component. See <b>Technical Data</b> in all equipment manuals.</li> <li>• Use fluids and solvents that are compatible with equipment wetted parts. See <b>Technical Data</b> in all equipment manuals. Read fluid and solvent manufacturer's warnings. For complete information about your material, request Safety Data Sheets (SDSs) from distributor or retailer.</li> <li>• Do not leave the work area while equipment is energized or under pressure.</li> <li>• Turn off all equipment and follow the <b>Pressure Relief Procedure</b> when equipment is not in use.</li> <li>• Check equipment daily. Repair or replace worn or damaged parts immediately with genuine manufacturer's replacement parts only.</li> <li>• Do not alter or modify equipment. Alterations or modifications may void agency approvals and create safety hazards.</li> <li>• Make sure all equipment is rated and approved for the environment in which you are using it.</li> <li>• Use equipment only for its intended purpose. Call your distributor for information.</li> <li>• Route hoses and cables away from traffic areas, sharp edges, moving parts, and hot surfaces.</li> <li>• Do not kink or over bend hoses or use hoses to pull equipment.</li> <li>• Keep children and animals away from work area.</li> <li>• Comply with all applicable safety regulations.</li> </ul>

# Installation

<p>Installation of this equipment involves potentially hazardous procedures. Only trained and qualified personnel who have read and who understand the information in this manual should install this equipment.</p>				

**NOTE:** To install an advanced motor, also see [Intrinsically Safe Installation Requirements for Advanced Motors](#), page 12.

## Check the Oil Level Before Using the Equipment

The motor is pre-filled with oil. Before using the equipment, replace the shipping plug with the vented fill cap (P) that is included with the motor.

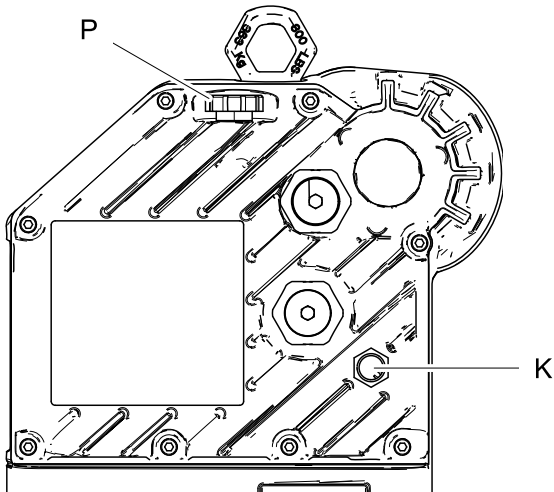

ti18022a

Figure 5 Sightglass and Oil Fill Cap

## Power Supply Requirements

<p>Improper wiring may cause electric shock or other serious injury if work is not performed properly. Have a qualified electrician perform any electrical work. Be sure your installation complies with all National, State and Local safety and fire codes.</p>				

See Table 1 for power supply requirements. The system requires a dedicated circuit protected with a circuit breaker.

Table 1 . Power Supply Specifications

Model*	Voltage	Phase	Hz	kVA
EM001x	100–130 /200–240 Vac	1	50/60	1.5
EM002x	200–240 Vac	1	50/60	2.9

\* The last digit of the Model No. varies. See the **Models** tables on pages 3–6.

## Hazardous Area Cabling and Conduit Requirements

### Explosion Proof

All electrical wiring in the hazardous area must be encased in Class I, Division I, Group D approved explosion-proof conduit. Follow all National, State, and Local electric codes.

A conduit seal (D) is required within 18 in. (457 mm) of the motor for the US and Canada.



All cables must be rated at 70°C.

### Flame Proof (ATEX and UKEX)

Use appropriate conduit, connectors, and cable glands rated for ATEX II 2 G. Follow all National, State, and Local electric codes.

All cable glands and cables must be rated at 70°C.

## Connect the Power Supply

				
<p>Improper wiring may cause electric shock or other serious injury if work is not performed properly. Have a qualified electrician perform any electrical work. Be sure your installation complies with all National, State and Local safety and fire codes.</p>				

1. Ensure that the fused safety switch (B) is shut off and locked out.

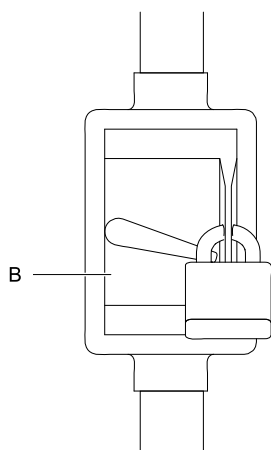

ti20170a

Figure 6 Locked Out Fused Safety Switch

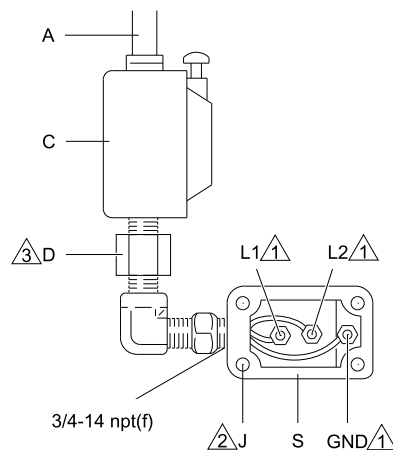

2. Install a start/stop control (C) in the electrical supply line (A), within easy reach of the equipment. The start/stop control must be approved for use in hazardous locations.
3. Open the electrical compartment (S) on the motor.

4. Bring the power wires into the electrical compartment through the 3/4–14 npt(f) inlet port. Connect the wires to the terminals, as shown. Torque the terminal nuts to 15 in-lb (2 N•m) maximum. **Do not over-torque.**
5. Close the electrical compartment. Torque the cover screws (J) to 15 ft-lb (20 N•m).



ti18021a

Figure 7 Connect the Power Wires

Notes for Fig. 7	
	Tighten all terminal nuts to 15 in-lb (2 N•m) maximum. <b>Do not over-torque.</b>
	Tighten cover screws to 15 ft-lb (20 N•m).
	A conduit seal (D) is required within 18 in. (457 mm) of the motor for the US and Canada.

## Grounding

<p>This equipment must be grounded to reduce the risk of static sparking and electric shock. Electric or static sparking can cause fumes to ignite or explode. Improper grounding can cause electric shock. Grounding provides an escape wire for the electric current.</p>				

Loosen the ground screw and attach a ground wire (Y). Tighten the ground screw securely. Connect the other end of the ground wire to a true earth ground.

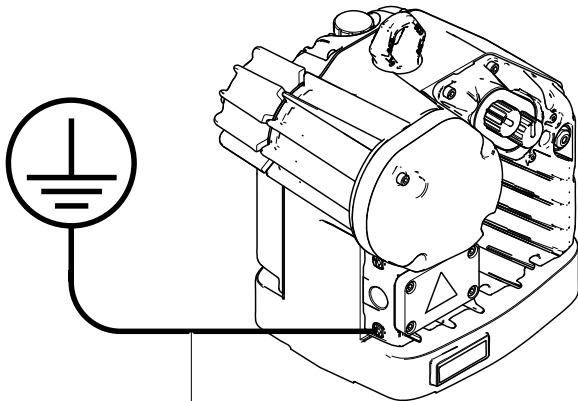

ti18019a

Figure 8 Ground Wire

## Intrinsically Safe Installation Requirements for Advanced Motors

<p>Do not substitute or modify system components as this may impair intrinsic safety. For installation, maintenance, or operation instructions, read instruction manuals. Do not install equipment approved only for non-hazardous location in a hazardous location. See the identification label for the intrinsic safety rating for your model.</p>				

See [Appendix A - System Control Drawing 24N637, page 19](#), for installation requirements and entity parameters. Follow all installation instructions in your system manual.

**NOTE:** For multiple advanced motors (EM00X2, EM00X4, EM00X5, and EM00X6) using a single advance control module, all motors must be bonded to the same high integrity equipotential system.

# Operation

## Startup

1. Unlock the fused safety switch (B) and turn it on. See [Connect the Power Supply, page 11](#).
2. Press the start pushbutton (C).
3. Check that the power indicator (L) is lit (steady on).
4. See [Advanced Motor Operation, page 13](#) or [Basic Motor Operation, page 14](#) for further instructions.

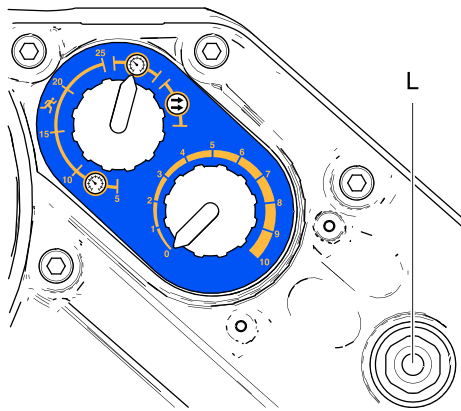

ti20259a

Figure 9 Power Indicator

## Shutdown

Follow the [Pressure Relief Procedure, page 13](#).

## Pressure Relief Procedure

<p>This equipment stays pressurized until pressure is manually relieved. To help prevent serious injury from splashing fluid and moving parts, follow the Pressure Relief Procedure when you stop spraying and before cleaning, checking, or servicing the equipment.</p>				

1. Disengage the start/stop control (C). See [Connect the Power Supply, page 11](#).
2. Shut off and lock out the fused safety switch (B).
3. Relieve all fluid pressure as explained in your separate E-Flo DC pump manual.

## Advanced Motor Operation

The Advanced E-Flo DC motors require installation of the 24P822 Control Module Accessory Kit to provide the interface for users to enter selections and view information related to setup and operation. See the Control Module Accessory Kit manual 3A2527 for installation and operation information.

<b>NOTICE</b>
<p>To prevent damage to the softkey buttons, do not press the buttons with sharp objects such as pens, plastic cards, or fingernails.</p>

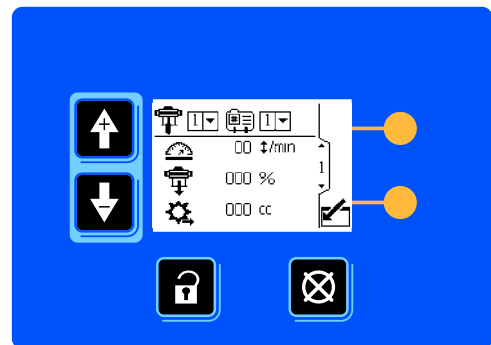



ti19866a

Figure 10 Control Module Accessory

## Basic Motor Operation

The basic motor has three operating modes:

- Pressure Mode 
- Pressure Mode with Integrated Runaway Protection 
- Flow Mode 

**NOTE:** Before changing from one mode to another, turn the Control Knob (N) fully counterclockwise to 0.

### Pressure Mode

When in pressure mode, the motor will adjust the speed to maintain a constant fluid pressure.

1. Turn the Control Knob (N) fully counterclockwise to 0.
2. Pull the Mode Select switch (M) out to set. Turn the switch to Pressure . Push the switch in to lock.
3. Pull the Control Knob (N) out to set. Turn the knob clockwise to increase the pressure, or counterclockwise to decrease the pressure. Push the knob in to lock.

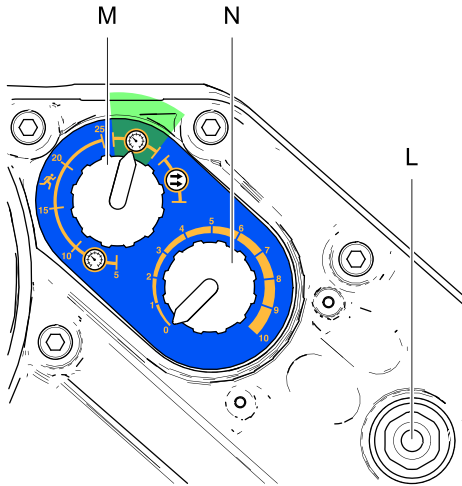

ti20171a

Figure 11 Pressure Mode

### Pressure Mode with Integrated Runaway Protection

In pressure mode with integrated runaway protection, the motor will adjust the speed to maintain a constant fluid pressure, but will shut down if it exceeds a user-set speed.

1. Turn the Control Knob (N) fully counterclockwise to 0.
2. Pull the Mode Select switch (M) out to set. In the Runaway  range, turn the switch to the desired shutdown speed in cycles per minute (5, 10, 15, 20, or 25). Push the switch in to lock.
3. Pull the Control Knob (N) out to set. Turn the knob clockwise to increase the pressure, or counterclockwise to decrease the pressure. Push the knob in to lock.

**NOTE:** The motor will shut down if the selected speed is exceeded for 5 cycles. To reset, turn the Control Knob (N) fully counterclockwise to 0, then turn to the desired pressure.

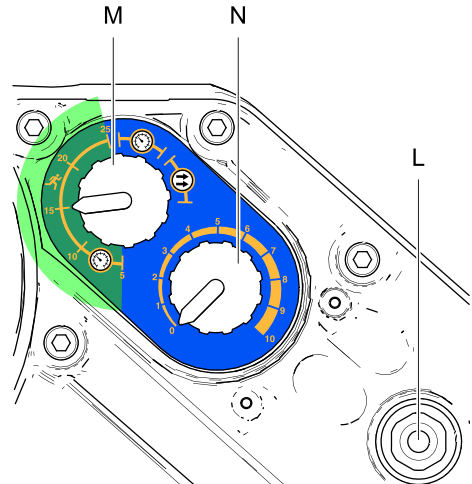

ti20172a

Figure 12 Pressure Mode with Integrated Runaway Protection

## Flow Mode

When in flow mode, the motor will maintain a constant speed regardless of the fluid pressure, up to the pump's maximum working pressure. See [Technical Data, page 25](#).

1. Turn the Control Knob (N) fully counterclockwise to 0.
2. Pull the Mode Select switch (M) out to set. Turn the switch to Flow . Push the switch in to lock.
3. The amount of flow is determined by the cycle rate set with the Control Knob (N). The knob's scale (0–10) corresponds to a cycle adjustment range of 0-30 cycles per minute. Turn the Control Knob (N) clockwise to increase the cycle rate (flow), or counterclockwise to decrease the cycle rate (flow).

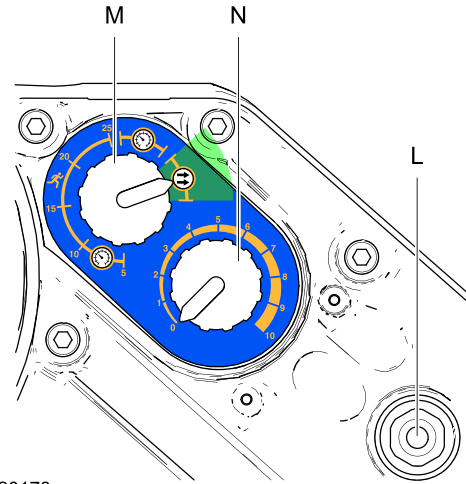

ti20173a

Figure 13 Flow Mode

# Maintenance

## Preventive Maintenance Schedule

The operating conditions of your particular system determine how often maintenance is required. Establish a preventive maintenance schedule by recording when and what kind of maintenance is needed, and then determine a regular schedule for checking your system.

## Change the Oil

**NOTE:** Change the oil after a break-in period of 200,000–300,000 cycles. After the break-in period, change the oil once a year. Order two Part No. 16W645 ISO 220 silicone-free synthetic gear oil.

1. Place a minimum 2 quart (1.9 liter) container under the oil drain port. Remove the oil drain plug (25). Allow all oil to drain from the motor.
2. Reinstall the oil drain plug (25). Torque to 25–30 ft-lb (34–40 N•m).
3. Open the fill cap (P) and add Graco Part No. 16W645 ISO 220 silicone-free synthetic gear oil. Check the oil level in the sight glass (K). Fill until the oil level is near the halfway point of the sight glass. The oil capacity is approximately 1.5 quarts (1.4 liters). **Do not overfill.**
4. Reinstall the fill cap.

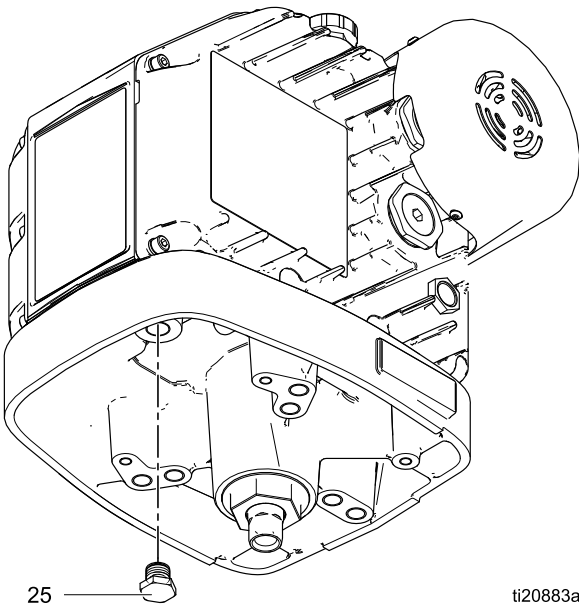
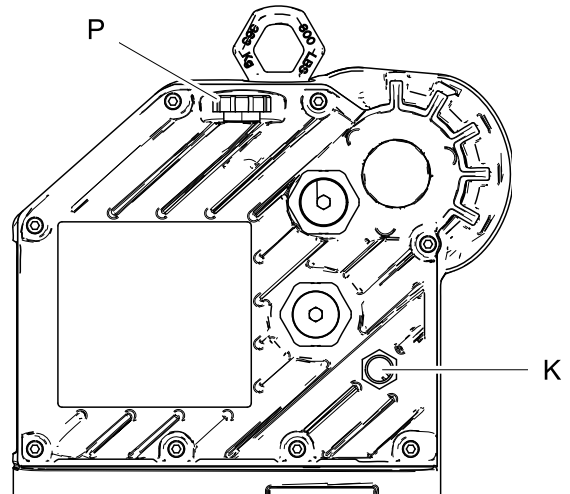

Figure 14 Oil Drain Plug

## Check the Oil Level

Check the oil level in the sight glass (K). The oil level should be near the halfway point of the sight glass when the unit is not running. If low, open the fill cap (P) and add Graco Part No. 16W645 ISO 220 silicone-free synthetic gear oil as required. **Do not overfill.**



ti19679b



Figure 15 Sightglass and Oil Fill Cap



# Error Code Troubleshooting

**NOTE:** The blink code is displayed using the power indicator on the motor. The blink code given below indicates the sequence. For example, blink code 2–6

indicates 2 blinks, then 6 blinks. The sequence then repeats.

Blink Code	Description
1	Flow exceeds maximum target; also indicates pump runaway condition exists.
2	Brown out; voltage supplied to motor is too low.
3	Over voltage; the motor supply voltage is too high. For DuraFlo and Xtreme lowers, cavitation at changeover can cause this alarm by turning the motor into a generator. For all lowers, if the inlet is pressurized enough, the motor can be pushed to generate enough voltage to cause this alarm.
4	An internal control board hardware failure is detected.
5	Over temperature.
6	The Mode Select knob is set between Pressure  and Flow  . Set the knob to the correct mode.
7	Low supply voltage detected at startup.
2–6	AC power is lost.
3–5	Internal thermistor disconnected.
3–4	Software versions do not match.
3–6	Circuit board communication failure.
4–5	Internal software error.
5–6	A calibration of the automatic encoder and stroke range is in process. (This process is initiated from the DIP switch that is internal to the motor.)

# Accessories

Motor Part No.	Description	Kits	Kit Description
Models EM00X2 and EM00X5	E-Flo DC Advanced Motors	24P822	Control Module, for Advanced Motors; see manual 3A2527.
Models EM00X4 and EM00X6	E-Flo DC Advanced Motors	24X599	Control Module, for Advanced Motors; see manual 3A2527.
Models EM00X2, EM00X4, EM00X5, and EM00X6	E-Flo DC Advanced Motors	16P911	CAN Cable, 3 ft (1 m)
		16P912	CAN Cable, 25 ft (8 m)
		24P979	Pneumatic Control for Back Pressure Regulator; see manual 332142.
		24R050	Pressure Transducer Kit
		16U729	Start/Stop Switch. Allows pump to be shut off while maintaining power to the control module.
All motors in this manual	Connection kits, to mount an E-Flo DC Motor to an existing pump lower. Kits include tie rods, tie rod nuts, adapter, and coupler.	288203	For 3000 and 4000 cc 4-Ball Lowers
		288204	For Dura-Flo 1800 and 2400 Lowers
		288205	For Dura-Flo 600, 750, 900, and 1200 Lowers
		288206	For Dura-Flo 1000 Lowers
		288207	For Xtreme 145, 180, 220, 250, and 290 Lowers
		288209	For 750, 1000, 1500, and 2000 cc 4-Ball Lowers with Enclosed or Open Wet Cup
		288860	For Xtreme 85 and 115 Lowers
		17K525	For 750, 1000, 1500, and 2000 cc Sealed 4-Ball Lowers

# Appendix A - System Control Drawing 24N637

## NOTES FOR FIG. 16 AND 17:

1. The non-intrinsically safe terminals (power rail) must not be connected to any device which uses or generates more than  $U_m = 250$  Vrms or dc unless it has been determined that the voltage has been adequately isolated.
2. For multiple advanced motors (EM00X2, EM00X4, EM00X5, and EM00X6) using a single advance control module, all motors must be bonded to the same high integrity equipotential system.
3. Do not remove any cover until power has been removed.
4. Installation should be in accordance with ANSI/ISA RP12.06.01, installation of intrinsically safe systems for hazardous (classified) locations, and the National Electrical Code (ANSI/NFPA 70).
5. Installation in Canada should be in accordance with the Canadian Electrical Code, CSA C22.1, Part 1, Appendix F.
6. For ATEX and UKEX, install per EN 60079-14 and applicable local and national codes.
7. Between one and eight motors may be connected in series. The motors are connected with a CAN cable (16P911 or 16P912). The side of the cable with the red marking is connected to Port 1 of one motor and the unmarked side of the cable is connected to Port 2 of the next motor.
8. The first motor in the series (the one with no CAN cable on Port 2) is installed with the power jumper 24N910 connected to Port 2 and Port 3.

9. The "last" motor in the series is connected to either an IS apparatus in the hazardous location or an associated IS apparatus in the non-hazardous location. The side of the CAN cable with the red marking is connected to Port 1 of the last motor and the unmarked side of the cable is connected to the IS or associated IS apparatus.
10. The output entity parameters given for Pins 1 and 4 in each of Ports 1 and 2 are the total current and power available to both pins added together. The current on Pin 1 and Pin 4 added together will not exceed the listed  $I_o$ , and the power output from Pin 1 and Pin 4 added together will not exceed the listed  $P_o$ .

	<p><b>WARNING:</b> Substitution of components may impair intrinsic safety.</p>
	<p><b>ADVERTISSEMENT:</b> La substitution de composants peut compromettre la securite intrinseque.</p>

**Table 2 . Calculation Procedures**

Zones
$U_o \leq U_i$
$I_o \leq I_i$
$P_o \leq P_i$
$C_o \geq C_i + C_{cable}$
$L_o \geq L_i + L_{cable}$
$L_o / R_o \geq L_i / R_i$

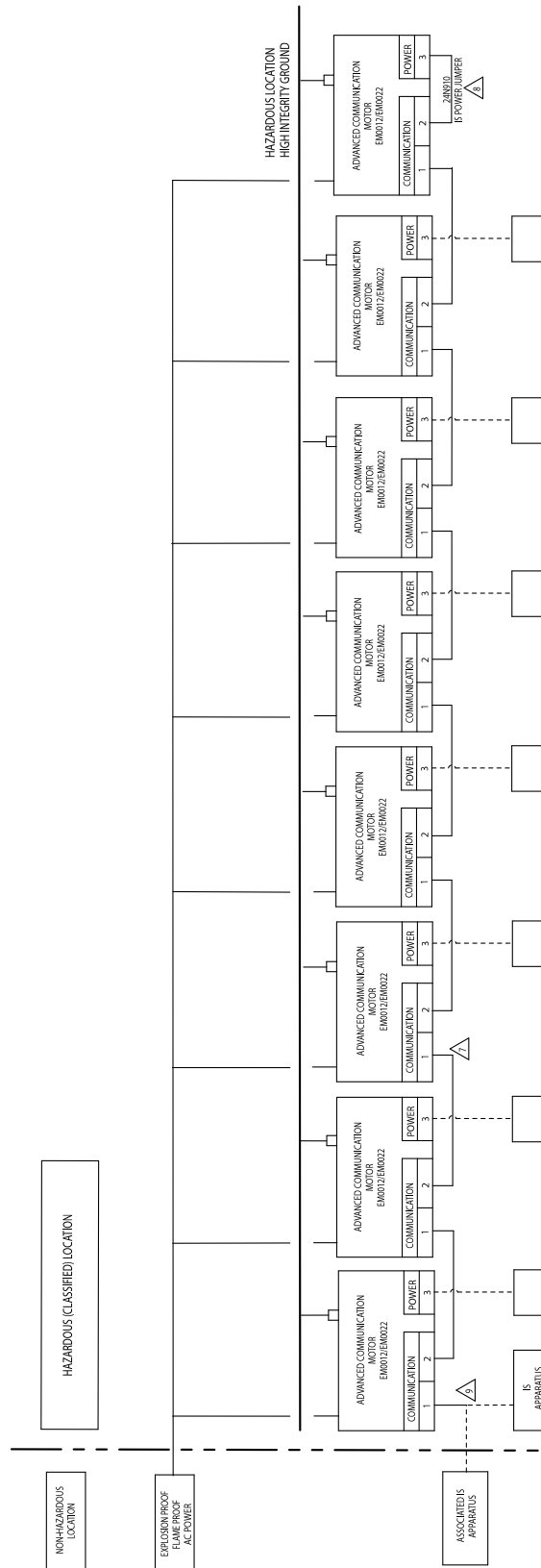
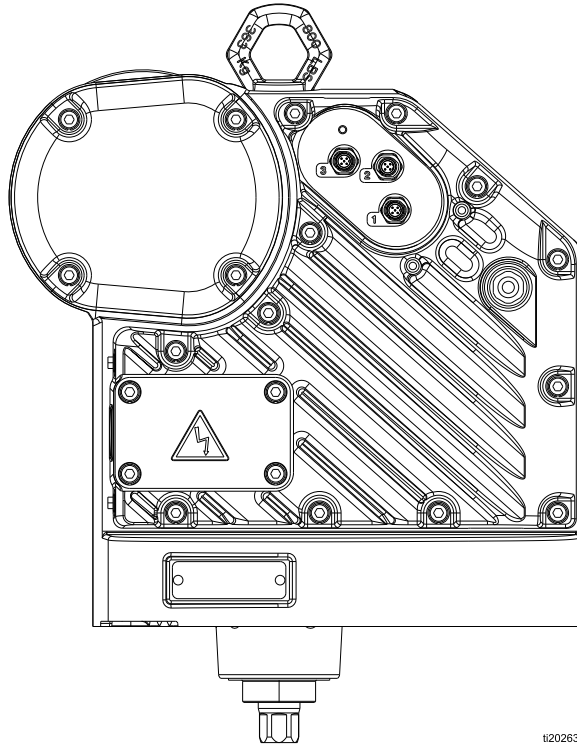

Figure 16 System Control Drawing 24N637, Sheet 1



ti20263a

Figure 17 System Control Drawing 24N637, Sheet 2

Table 3 . Port 3: Power Barrier Output Parameters

Power Barrier Output Parameters							
Port 3: Male M12 5 Pin "A" Key	Pin	Units	Voc	Isc	Pt	La	Ca
			Vmax	mA	mW	μH	μF
	1	CAN Data Low	Not Connected				
	2	Power	17.9	646	2891	681	7.7
	3	IS Ground Return	—	—	—	—	—
	4	CAN Data High	Not Connected				
	5	Shield	—	—	—	—	—

ti20262a

**Table 4 . Ports 1 and 2: CAN Data/Power In and Out Entity Parameters**

CAN Data High/Low Input Loads								
Port 2: Male M12 5 Pin "B" Key   Port 1: Male M12 5 Pin "A" Key  	Pin	Units	Vmax	I <sub>max</sub>	P <sub>i</sub>	L <sub>i</sub>	C <sub>i</sub>	
			Vmax	mA	mW	μH	μF	
	1	CAN Data Low	See Table 5 for Data based on the Number of Motors					
	2	VIN Power	17.9	725	2900	128	0	
	3	Signal Ground	—	—	—	—	—	
	4	CAN Data High	See Table 5 for Data based on the Number of Motors					
	5	Shield	—	—	—	—	—	
CAN Data High/Low Output Barriers								
Port 2: Male M12 5 Pin "B" Key   Port 1: Male M12 5 Pin "A" Key  	Pin	Units	Voc	I <sub>sc</sub>	P <sub>t</sub>	L <sub>a</sub>	C <sub>a</sub>	
			Vmax	mA	mW	μH	μF	
	1	CAN Data Low	See Table 5 for Data based on the Number of Motors					
	2	VIN Power	17.9	646	2891	681	7.7	
	3	Signal Ground	—	—	—	—	—	
	4	CAN Data High	See Table 5 for Data based on the Number of Motors					
	5	Shield	—	—	—	—	—	

Table 5 . Ports 1 and 2, Pins 1 and 4: CAN Data High and Low (applies to all CAN data pins shorted together or to any individual pin; see Note 10 on page 26)

CAN Data High/Low Input Loads						
Number of Motors	Units	Vmax	I <sub>max</sub>	P <sub>i</sub>	Li	Ci
		Vmax	mA	mW	μH	μF
1		6	700	900	67	0.2
2		6	700	900	67	0.4
3		6	700	900	67	0.6
4		6	700	900	67	0.8
5		6	700	900	67	1.0
6		6	700	900	67	1.2
7		6	700	900	67	1.4
8		6	700	900	67	1.6
CAN Data High/Low Output Barriers						
Number of Motors	Units	V <sub>oc</sub>	I <sub>sc</sub>	P <sub>t</sub>	La	Ca
		Vmax	mA	mW	mH	μF
1		4.94	102	79	27.3	1000
2		4.94	179	158	8.88	1000
3		4.94	246	237	4.70	1000
4		4.94	305	316	3.06	1000
5		4.94	358	395	2.22	1000
6		4.94	407	474	1.72	1000
7		4.94	452	553	1.39	1000
8		4.94	494	632	1.17	1000

# Dimensions and Mounting Holes

## E-Flo DC Motor Dimensions

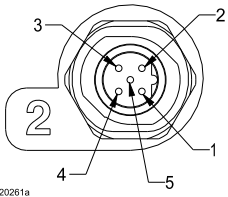
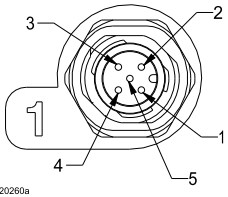
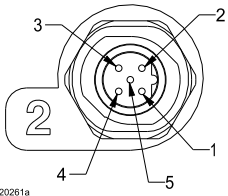
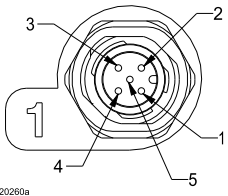
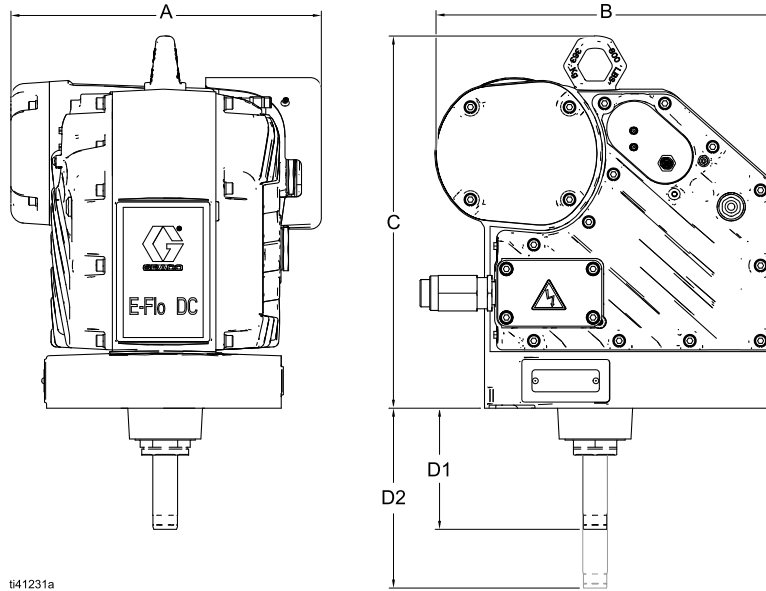

ti41231a

A	B	C	D1	D2
14.07 in. (35.74 cm)	15.54 in. (39.47 cm)	16.79 in. (42.65 cm)	5.44 in. (13.82 cm)	8.18 in. (20.78 cm)

## Mounting Hole Pattern

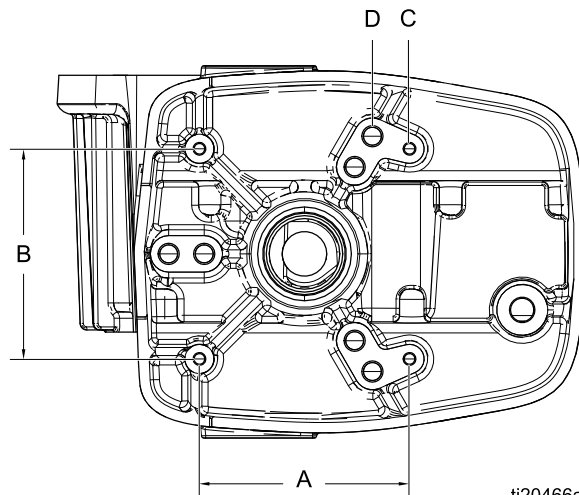

ti20466a

A	B	C	D
6.186 in. (157 mm)	6.186 in. (157 mm)	Four 3/8–16 Mounting Holes	Six 5/8–11 Tie Rod Holes: <ul style="list-style-type: none"> <li>• 8 in. (203 mm) x 120° bolt circle</li> <li>OR</li> <li>• 5.9 in. (150 mm) x 120° bolt circle</li> </ul>



# Technical Data

E-Flo DC Motors	U.S.	Metric
<b>Input voltage/Power:</b>		
Models EM0011, EM0012, EM0013, EM0014, EM0015, and EM0016	100–130/ 200–240 VAC single phase, 50/60 Hz, 1.5 kVA	
Models EM0021, EM0022, EM0023, EM0024, EM0025, and EM0026	200–240 VAC, single phase, 50/60 Hz, 2.9 kVA	
<b>Maximum potential fluid pressure:</b>		
Models EM0011, EM0012, EM0013, EM0014, EM0015, and EM0016	218000/v (volume of lower in cc) = psi	14500/v (volume of lower in cc) = bar
Models EM0021, EM0022, EM0023, EM0024, EM0025, and EM0026	436000/v (volume of lower in cc) = psi	29500/v (volume of lower in cc) = bar
Maximum continuous cycle rate	20 cpm	
<b>Maximum force:</b>		
Models EM0011, EM0012, EM0013, EM0014, EM0015, and EM0016	1400 lbf	6227 N
Models EM0021, EM0022, EM0023, EM0024, EM0025, and EM0026	2800 lbf	12455 N
Power inlet port size	3/4–14 npt(f)	
Ambient temperature range	32–104°F	0–40°C
Sound data	Less than 70 dB(A)	
Oil capacity	1.5 quarts	1.4 liters
Oil specification	Graco Part No. 16W645 ISO 220 silicone-free synthetic gear oil	
Weight	99 lb	45 kg

## California Proposition 65

### CALIFORNIA RESIDENTS

 **WARNING:** Cancer and reproductive harm — [www.P65warnings.ca.gov](http://www.P65warnings.ca.gov).

# Graco Standard Warranty

Graco warrants all equipment referenced in this document which is manufactured by Graco and bearing its name to be free from defects in material and workmanship on the date of sale to the original purchaser for use. With the exception of any special, extended, or limited warranty published by Graco, Graco will, for a period of twelve months from the date of sale, repair or replace any part of the equipment determined by Graco to be defective. This warranty applies only when the equipment is installed, operated and maintained in accordance with Graco's written recommendations.

This warranty does not cover, and Graco shall not be liable for general wear and tear, or any malfunction, damage or wear caused by faulty installation, misapplication, abrasion, corrosion, inadequate or improper maintenance, negligence, accident, tampering, or substitution of non-Graco component parts. Nor shall Graco be liable for malfunction, damage or wear caused by the incompatibility of Graco equipment with structures, accessories, equipment or materials not supplied by Graco, or the improper design, manufacture, installation, operation or maintenance of structures, accessories, equipment or materials not supplied by Graco.

This warranty is conditioned upon the prepaid return of the equipment claimed to be defective to an authorized Graco distributor for verification of the claimed defect. If the claimed defect is verified, Graco will repair or replace free of charge any defective parts. The equipment will be returned to the original purchaser transportation prepaid. If inspection of the equipment does not disclose any defect in material or workmanship, repairs will be made at a reasonable charge, which charges may include the costs of parts, labor, and transportation.

**THIS WARRANTY IS EXCLUSIVE, AND IS IN LIEU OF ANY OTHER WARRANTIES, EXPRESS OR IMPLIED, INCLUDING BUT NOT LIMITED TO WARRANTY OF MERCHANTABILITY OR WARRANTY OF FITNESS FOR A PARTICULAR PURPOSE.**

Graco's sole obligation and buyer's sole remedy for any breach of warranty shall be as set forth above. The buyer agrees that no other remedy (including, but not limited to, incidental or consequential damages for lost profits, lost sales, injury to person or property, or any other incidental or consequential loss) shall be available. Any action for breach of warranty must be brought within two (2) years of the date of sale.

**GRACO MAKES NO WARRANTY, AND DISCLAIMS ALL IMPLIED WARRANTIES OF MERCHANTABILITY AND FITNESS FOR A PARTICULAR PURPOSE, IN CONNECTION WITH ACCESSORIES, EQUIPMENT, MATERIALS OR COMPONENTS SOLD BUT NOT MANUFACTURED BY GRACO.** These items sold, but not manufactured by Graco (such as electric motors, switches, hose, etc.), are subject to the warranty, if any, of their manufacturer. Graco will provide purchaser with reasonable assistance in making any claim for breach of these warranties.

In no event will Graco be liable for indirect, incidental, special or consequential damages resulting from Graco supplying equipment hereunder, or the furnishing, performance, or use of any products or other goods sold hereto, whether due to a breach of contract, breach of warranty, the negligence of Graco, or otherwise.

## FOR GRACO CANADA CUSTOMERS

The Parties acknowledge that they have required that the present document, as well as all documents, notices and legal proceedings entered into, given or instituted pursuant hereto or relating directly or indirectly hereto, be drawn up in English. Les parties reconnaissent avoir convenu que la rédaction du présente document sera en Anglais, ainsi que tous documents, avis et procédures judiciaires exécutés, donnés ou intentés, à la suite de ou en rapport, directement ou indirectement, avec les procédures concernées.

## Graco Information

For the latest information about Graco products, visit [www.graco.com](http://www.graco.com). For patent information, see [www.graco.com/patents](http://www.graco.com/patents).

**To place an order**, contact your Graco Distributor or call to identify the nearest distributor.

**Phone:** 612-623-6921 **or Toll Free:** 1-800-328-0211 **Fax:** 612-378-3505

All written and visual data contained in this document reflects the latest product information available at the time of publication.

Graco reserves the right to make changes at any time without notice.

Original Instructions. This manual contains English, MM 3A2526

**Graco Headquarters:** Minneapolis

**International Offices:** Belgium, China, Japan, Korea

**GRACO INC. AND SUBSIDIARIES • P.O. BOX 1441 • MINNEAPOLIS, MN 55440-1441 • USA**  
**Copyright 2012, Graco Inc. All Graco manufacturing locations are registered to ISO 9001.**

[www.graco.com](http://www.graco.com)  
Revision T, October 2022