

Programmable Skipline Controller for RoadLazer™ RoadPak™ Line Striping System

3A5387B

EN

For the application of road marking reflective materials. For professional use only.

Model 24S169 - Controller Only

Model 25M711 - Controller, Cable, Remote Switch and Bracket

Model 25D887 - OEM Control and Electrical components



Important Safety Instructions

Read all warnings and instructions in this manual, related manuals, and on the equipment. Be familiar with the controls and the proper usage of the equipment. Save these instructions.



Table of Contents

Warnings	3	Setup Menu	14
Component Identification and Function	4	Setup/System/General	15
Front of Controller	4	Setup/System/Calibrations	16
Component Identification and Function	5	Units	18
Back of Controller	5	Pump Setup	18
Installation	6	Life Totals	18
Mount Programmable Skipline Control	6	Gun Color	19
Connect the Control Cable	6	Gun Width	19
Navigation Overview	7	Paint & Bead Gun Offsets	20
Main Menu	8	Paint & Bead Gun Delays	20
Remote Trigger	9	Align Solids (Aligning Solid [no-passing] lines with skip lines)	21
Quick Setup Menu	10	Shadow	22
Menu Page 1/3	10	Marker Layout	23
Menu Page 2/3	10	Midspot	24
Quick Setup Menu (continued)	11	Zipper	25
Menu Page 3/3 (2 Gun Standard Units ONLY) .	11	Speed Range	26
Counter Channels Menu	12	Switch Test	26
Guns	12	Input Test	26
Trip	12	Button Test	26
Pattern	12	Pulse Counts	27
Pumps	13	GPS Status	27
Totals	13	System Delay Setup	28
Options	13	Troubleshooting	29
		Information System	30
		Parts	31
		OEM Kit (25D887) and Control Kit (25M711) . .	31
		Wiring Diagram	32
		Schematics - OEM Components	32
		OEM Installation	33
		Additional Accessories and Electrical Options .	33
		Technical Specifications	34
		Graco Standard Warranty	35
		Graco Information	36

Warnings

The following warnings are for the setup, use, grounding, maintenance, and repair of this equipment. The exclamation point symbol alerts you to a general warning and the hazard symbols refer to procedure-specific risks. When these symbols appear in the body of this manual or on warning labels, refer back to these Warnings. Product-specific hazard symbols and warnings not covered in this section may appear throughout the body of this manual where applicable.

WARNING



EQUIPMENT MISUSE HAZARD

Misuse can cause death or serious injury.

- Do not operate the unit when fatigued or under the influence of drugs or alcohol.
- Do not exceed the maximum working pressure or temperature rating of the lowest rated system component. See **Technical Data** in all equipment manuals.
- Use fluids and solvents that are compatible with equipment wetted parts. See **Technical Data** in all equipment manuals. Read fluid and solvent manufacturer's warnings. For complete information about your material, request Safety Data Sheet (SDS) from distributor or retailer.
- Do not leave the work area while equipment is energized or under pressure.
- Turn off all equipment and follow the **Pressure Relief Procedure** when equipment is not in use.
- Check equipment daily. Repair or replace worn or damaged parts immediately with genuine manufacturer's replacement parts only.
- Do not alter or modify equipment. Alterations or modifications may void agency approvals and create safety hazards.
- Make sure all equipment is rated and approved for the environment in which you are using it.
- Use equipment only for its intended purpose. Call your distributor for information.
- Route hoses and cables away from traffic areas, sharp edges, moving parts, and hot surfaces.
- Do not kink or over bend hoses or use hoses to pull equipment.
- Keep children and animals away from work area.
- Comply with all applicable safety regulations.

Component Identification and Function

Front of Controller



	Switch / Indicator	Explanation
A - D	Programmable Quick Select Buttons	Provides menu specific commands as display on LCD screen. See page 7.
E	Power ON/OFF Switch	ON enables battery DC power to the Skipline Control. OFF removes power from the Control and grounds the engine spark-plug. Engine can not be started when this switch is in the OFF position. NOTE: This switch is also used to perform an emergency shutdown of the entire system.
F	Paint Gun Switches 1, 2, 3, 4 and 5	Enables/disables paint guns 1, 2, 3, 4 and 5. Up: Skip Line. Center: Off. Down: Continuous Line.
G	RESET/HOLD Switch	HOLD: Disables paint guns 1, 2, 3, 4 and 5 and resets the internal cycle counter. RESET: Resets the internal cycle counter but does not affect continuous line activity. If switch is held in RESET, a new cycle will not begin until the switch is released.
J	Joystick	Used to navigate between menus, adjusting values and resetting values.
K	Remote Trigger	Allows user to operate guns in Manual, Automatic, or Semi Automatic modes.

Component Identification and Function

Back of Controller

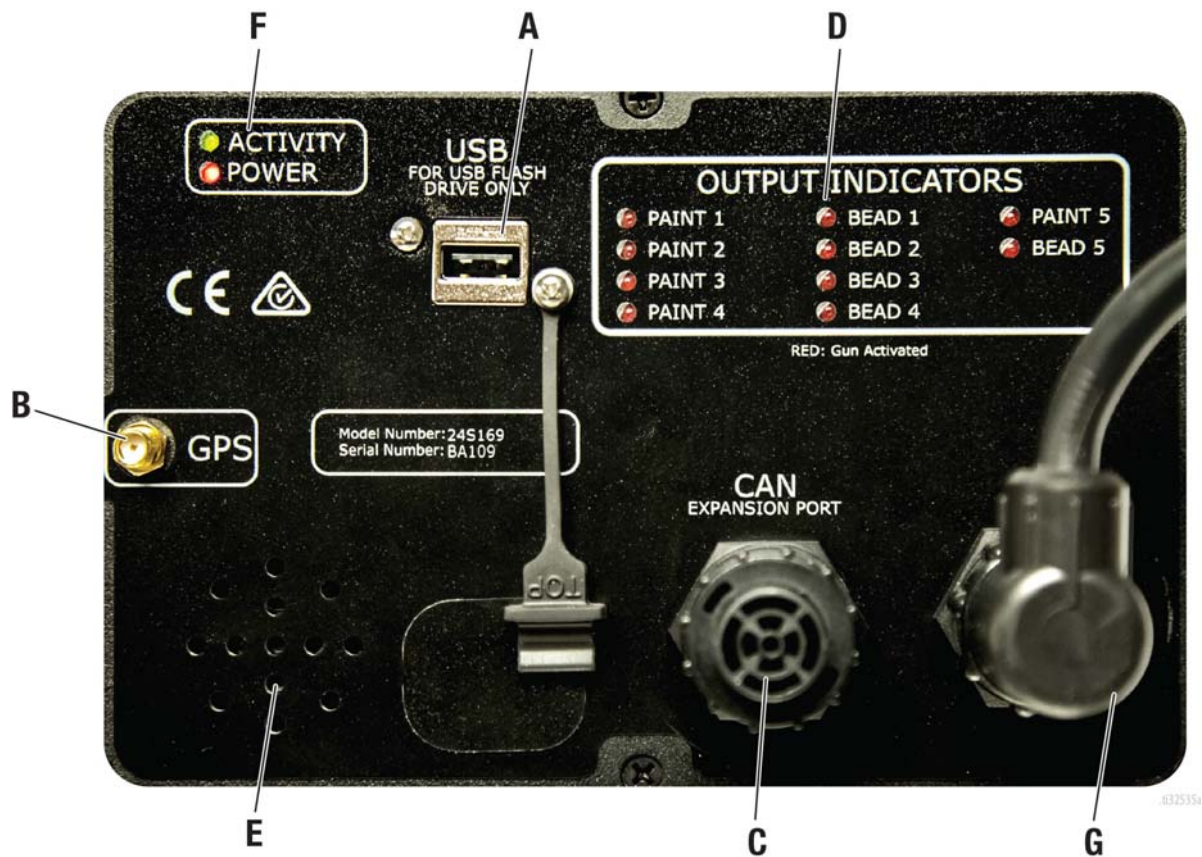

	Switch / Indicator	Explanation
A	USB Port	Used for data extraction and software update.
B	GPS Connector	Ability to record GPS coordinates with data extraction.
C	CAN Expansion Port	Allows for additional devices to be connected to the SkipLine Controller, such as a printer.
D	Output Indicators	If LED is illuminated, the associated Paint or Bead gun is activated.
E	Speaker	Provides audio for speed alarms and warnings.
F	Activity/Power Indicator	LED's to indicate functionality of the control.
G	I/O cable port	The control cable connects here and at the striping system. The cable also brings in 12 VDC from the striping system. See page XX.

Installation

Mount Programmable Skipline Control

Mount the Skipline Controller where it is easily visible and will not interfere with your view of the road. It should take no longer to look at the controller than it does to look at a rear-view mirror.

Place the Control in a position that is comfortable and easy to use. If you decide to mount the control, mount the 0.50" (13mm) wide mounting bracket to a solid location.

Connect the Control Cable

Clean all connections of dirt, burrs and moisture before connecting them to the system.

Navigation Overview

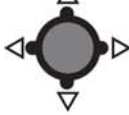

- The Joystick navigates the user through the four top level menus and down into each screen to adjust values or settings.
- The cursor location is always highlighted in green unless you change themes.
- To navigate between the four top level menus, the cursor must be at the top of the display.
- When in a menu, press and hold the joystick in the up position to jump the cursor to the top of the menu.





MAIN MENU	QUICK SETUP	COUNTER CHANNELS	SETUP
<p>See Page 8</p> <p>Programmable Quick Selects: A, B, C, D</p> <p>Pattern Preview</p> <p>Speed Display</p> <p>Mil Build Display</p> <p>Adjustable Paint & Space Values</p> <p>Global Bead Adjustment</p> <p>Odometer</p> <p>Distance Measurement</p>	<p>See Page 9</p> <p><i>Enable or Disable the following:</i></p> <p>Quick Selects Setup: A, B, C, D</p> <p>System Delay: On/Off</p> <p>Modes: Normal/Test/Shadow/Marker/Zipper</p> <p>Remote Trigger: Off/Manual/Auto/Semi</p> <p>Start On: Paint/Space</p> <p>Bead Test</p> <p>Bead Guns: On/Off</p> <p>Black Beads: On/Off</p> <p>Align Solids: On/Off</p> <p>Midspot: None/Odd/Even/Both</p> <p>Speed Alarm: On/Off</p> <p>Gun #1 Color: Yellow/White/Black</p> <p>Gun #2 Color: Yellow/White/Black</p>	<p>See Page 11</p> <p>Gun Counters</p> <p>Gun Trip Counters</p> <p>Pattern Counters</p> <p>Pump Gallon Counters</p> <p>Total Solid & Skip Line</p> <p>Options: Save/Clear/Print</p>	<p>See Page 13</p> <p>System:</p> <ul style="list-style-type: none"> • General: Language, Adv/Retard, Space/Cycle • Calibration: Distance/Pump • Units: English/Metric • Pump Setup: Yellow/White/Black • Life Totals <p>Gun Setup:</p> <ul style="list-style-type: none"> • Color & Width • Paint & Bead Gun Offsets • Paint & Bead Gun Delays <p>Extras:</p> <ul style="list-style-type: none"> • Alignment • Shadow • Marker Layout • Midspot • Zipper • Speed Range <p>Help:</p> <ul style="list-style-type: none"> • Switch Test • Input test • Button Test • Pulse Count • GPS Status <p style="text-align: right;">132444a</p>

Main Menu

The main menu is the first top-level screen that provides fast access to the most important day-to-day parameters of operation. The main menu is the recommended screen to use during striping operations.



Ref.	Description
1	Quick Selects A, B, C, D: Four programmable “favorites” that can easily be accessed from the main menu. Any setup options from the Quick Setup Menu can be programmed into a Quick Select Button. See page 9.
2	Pattern Presets: If chosen as a Quick Select option, 8 different Paint/Space values can be programmed as pattern presets. This feature works like the radio presets in a car. To set a preset, input the desired Paint and Space values and then press and hold the quick select button to set it. To choose to spray a preset pattern, navigate to the desired pattern and press the button. The Paint/Space values will be populated with the preset values.
3	Bead Adjustments: Fine tune the bead guns turning on and off to ensure the paint line is fully beaded and to prevent wasting beads on unpainted areas.
4	Speedometer: Measures and displays the speed of the vehicle.
5	Application Rate: Displays the mil build being applied. Gun width must be entered for proper calculation.
6	Pattern Preview: Provides a preview of the current pattern that will be emitted from the guns based off of the settings the user has inputted.
7	Gun Setup Preview: For some zipper patterns and Shadow patterns paint guns will be in line with each other. This can be inputted into the controller and displayed on the gun locator in the pattern preview. When a gun is firing, the gun number lights up white and when it's not, it will stay gray.

Ref.	Description
8	Distance: Shows the distance traveled since the Start switch was turned to the ON position. It will reset every time the switch is flipped to the ON position. Odometer: Shows the total Distance traveled with the Start switch on regardless of the gun switch positions, since the last counter channel clear.
9	<div style="display: flex; align-items: flex-start;"> <div style="margin-right: 10px;">  </div> <div> <p>Start Switch ON: The start switch is on. Solid guns may be on, but skip guns are off.</p> </div> </div> <div style="display: flex; align-items: flex-start; margin-top: 10px;"> <div style="margin-right: 10px;">  </div> <div> <p>Skip-Watch: The start switch is on, and the paint guns are in skip portion of the pattern (as opposed to the gap portion).</p> </div> </div> <div style="display: flex; align-items: flex-start; margin-top: 10px;"> <div style="margin-right: 10px;">  </div> <div> <p>GPS: The GPS icon indicates the status of the GPS. Animated signal bars indicate the GPS is searching for a satellite lock. No bars indicates a failure to associate (check antenna).</p> </div> </div> <div style="display: flex; align-items: flex-start; margin-top: 10px;"> <div style="margin-right: 10px;">  </div> <div> <p>USB Drive Attached: A USB drive is attached to the skip timer. Typically, USB drives should not be left attached after the counter channel export process is complete.</p> </div> </div> <div style="display: flex; align-items: flex-start; margin-top: 10px;"> <div style="margin-right: 10px;">  </div> <div> <p>USB Error: A USB device is attached, but is either not a USB drive or is not compatible.</p> </div> </div>

Remote Trigger

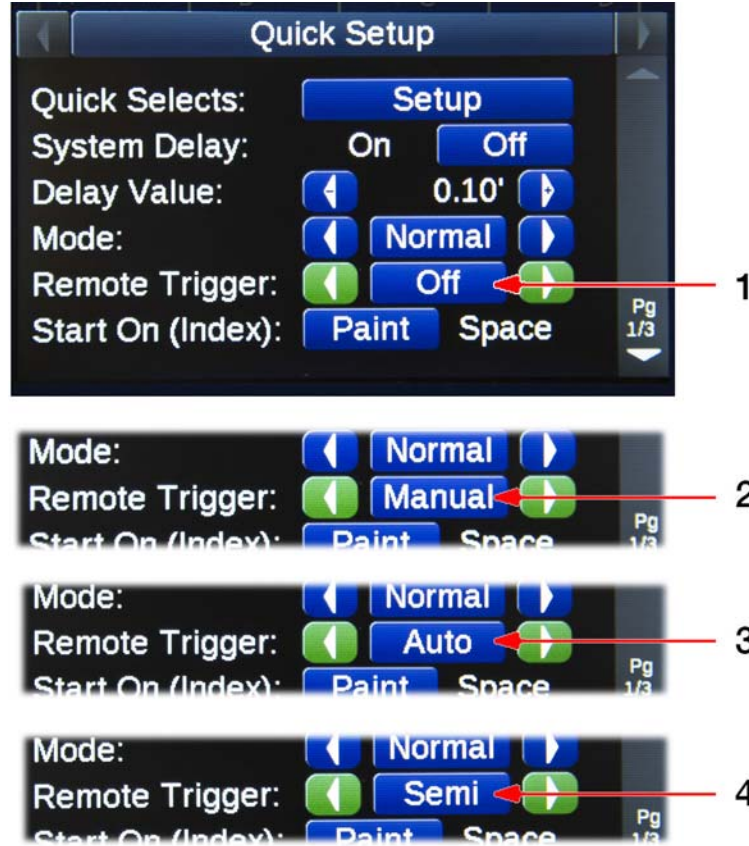

Ref.	Description
1	OFF: The remote trigger is ignored and the control works as if the remote trigger wasn't there.
2	Manual: The user must move the Start switch to the ON position and then the user must press and hold the remote trigger button continuously to activate any guns that are set to solid or skip. When the user releases the remote trigger button the guns will stop spraying. When not spraying, turn the Start switch to the OFF position to prevent accidental button presses activating the guns.
3	Automatic: The user must move the Start switch to the ON position and then the user must press and release the remote trigger button to activate any guns that are set to solid or skip. Those guns will continue to spray until the user presses the remote trigger button again. When not spraying, turn the Start switch to the OFF position to prevent accidental button presses activating the guns.
4	Semi-Automatic: The user must move the Start switch to the ON position. If a gun is set to skip, one single skip line will be laid when the remote button is pressed. If guns are only set to solid, one press of the remote trigger turns them on and another press of the remote trigger turns them off. A solid line can be spraying and then a gun switch gets flipped to skip. The remote trigger will start laying a skip line every time the remote trigger button is pressed, while still spraying the solid line. The guns can be turned off by moving the Start switch to the OFF position.

Quick Setup Menu

Menu Page 1/3

The Quick Setup menu provides quick access to enable or disable features that may be used during day-to-day operations. There are 3 pages in the Quick Setup menu.

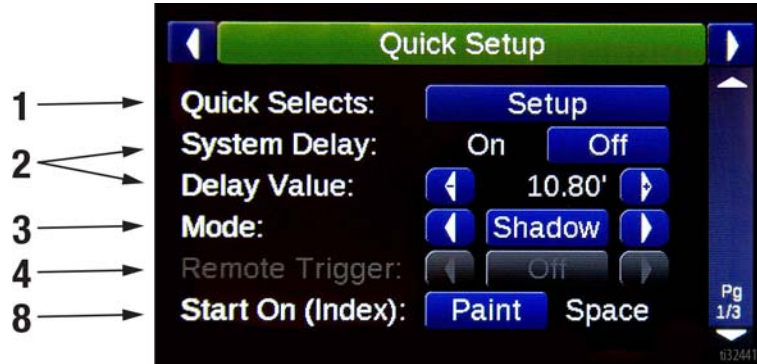

Ref.	Description
1	Quick Selects Setup: Enter the setup menu to choose the four options you want to be selectable by buttons A, B, C, and D on the main screen.
2	System Delay: Delays the Start and Stop of the guns in either solid or skip by the specified distance inputted in "Delay Value". Allows one-man operation by eliminating the need to look back at the gun to trigger then at the correct time. See Page 28.
3	Modes: Determines how the skip timer will behave: <ul style="list-style-type: none"> • Normal: Normal skip-timing behavior. • Test: Guns will come on immediately. This allows operators to test guns, regardless of any offsets or other settings.

Ref.	Description
3	<ul style="list-style-type: none"> • Shadow: Shadow patterns are enabled and can be sprayed per the chosen configuration in the Setup/Extras/Shadow menu. • Marker: Marker layout patterns are enabled and can be sprayed per the configuration in the Setup/Extras/Marker Layout menu. • Zipper: Zipper layout patterns are enabled and can be sprayed per the configuration in the Setup/Extras/Marker Layout menu.
4	Remote Trigger: Determines how the Remote Trigger will operate the control box. Off/Manual/Auto/Semi Auto. See Page 29.
5	Start On (Index): Choose if the skip pattern will start with paint first or space first.

Menu Page 2/3

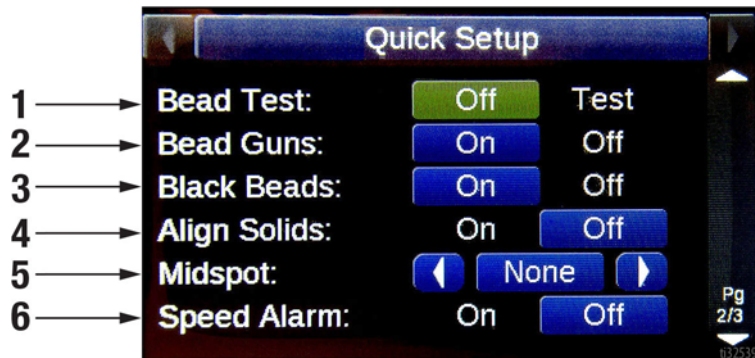

Ref.	Description
1	Bead Test: Press and hold the joystick to the right to test proper flow of any bead guns that are not set to the OFF position.
2	Bead Guns: Option to have beads guns activate when the paint guns are activated.
3	Black Beads: Option to have bead guns activate or not when the paint gun color is set to black.
4	Align Solids: Settings for a solid gun's alignment to a skip line can be enabled or disabled per the configuration in the Setup/Extras/Alignment menu.

Ref.	Description
5	Midspot: Choose to have a midspot or midspots sprayed between every odd skipline, even skipline, or both skiplines. Number of midspots and midspot dot length is setup in the Setup/Extras/Midspot menu.
6	Speed Alarm: Enable or Disable the Speed Alarm. Speed alarm configuration is setup in the Setup/Extras/Speed Range menu.

Quick Setup Menu (continued)

Menu Page 3/3 (2 Gun Standard Units ONLY)



1 →
2 →



Ref.	Description
1	Select the color so that pump counter accuracy and preview screen matches.
2	Same as above if a second gun is plumbed two-color.

Gun #1 and Gun#2 correspond to paint gun switches 1 and 2 only.

Counter Channels Menu

The Counter Channel menu provides access to distance and volume usage counters. Clearing the counter channels is common at the beginning of a new job.



Use the joystick to access the following Counter Channels pages: Guns, Trip, Pattern, Pumps, Totals and Options.

Guns



The gun counter channels allow the user to record width and/or color changes individually for each gun, providing enhanced records and job tracking. Counter channels fill in dynamically after a gun has distance associated with it. Guns that haven't been used won't appear on the screen.

Trip



The trip counter channels act like the trip odometer on vehicles. You can clear any trip counter individually, but the regular gun counters will remain intact, preserving your job footages and application rates. This feature may be useful for tracking a subsection of a job.

Pattern



The pattern counter channel will track different patterns that are sprayed with gun switch 1 and gun switch 2 only. This feature may be useful to contractors that bill jobs by pattern distance.

Pumps



The pump counter channel will track the gallons pumped for each color. Pumps must be set up with the proper color in the Setup/System/Pump Setup menu.

Totals



The totals counter channel will track the total distance of solid line sprayed, the total distance of skip line sprayed, and the total odometer distance recorded.

Options



This Skipline Controller has data logging capability and it can be extracted on a USB Flash Drive or printed out.

Save and Clear:

Saves the counter channels to internal memory and then clears the counters. This data can be extracted on a USB Flash drive and viewed in excel at a later date.

Clear without saving:

Will not save the counter channels. This is useful to clear usage or distances from testing or setup, without adding clutter among meaningful data.

Print Counters:

If a paper tape printer was purchase the data can be immediately printed out from for that job.

Setup Menu

The Setup menu has several sub-sections for fast and easy navigation of advanced system configurations.

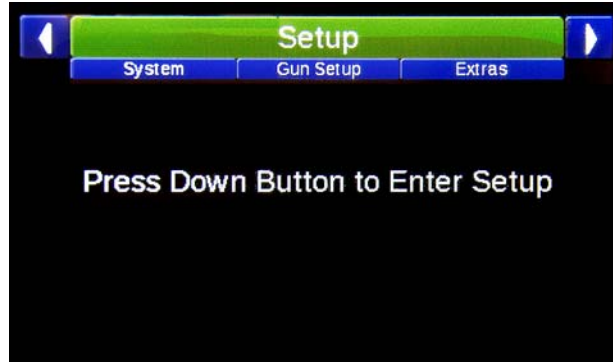

Use the joystick to access the following pages:

Setup/System/

- General, page 15.
- Calibrations, page 16.
- Units, page 18.
- Pump Setup, page 18.
- Life Tools, page 18.

Setup/Gun Setup/

- Gun Color, page 19.
- Gun Width, page 19.
- Paint & Bead Gun Offsets, page 20.
- Paint & Bead Gun Delays, page 20.

Setup/Extras/

- Alignment, page 21.
- Shadow, page 22.
- Marker Layout, page 23.
- Midspot, page 24.
- Zipper, page 25.
- Speed Range, page 26.

Setup/Help/

- Switch Test, page 26.
- Input Test, page 26.
- Button Test, page 26.
- Pulse Counts, page 27.
- GPS Status, page 27.

Setup/System/General

The General tab allows the user to adjust the systems basic settings.



tt32547/a

Ref.	Description
1	Language: English, French, Spanish, German, Chinese, Russian
2	Screen Brightness
3	Volume
4	Theme
5	Audio Warning: On/Off

Ref.	Description
6	Cycle/Space: Choose to use Paint and Cycle verbiage and distances for Skip Patterns or choose to use Paint and Space verbiage and distances for Skip Patterns.
7	Adv/Retard: On/Off.
8	Time zone: Set the time zone for accurate GPS tracking.

Setup/System/Calibrations

The skip timer must be properly calibrated for Distance and Pump Volume.

Distance Calibration

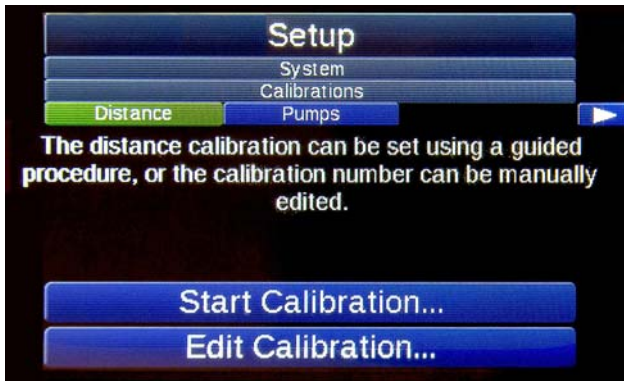

NOTE: The sensor will need to be recalibrated periodically due to wheel wear, and whenever the gun arm wheel is replaced. Tire air pressure can also affect calibration.

NOTE: Before calibrating, ensure that the gun-arm wheel is inflated to 40 psi and verify the control is counting the pulses prior to calibrating.

1. Measure and tape off an exact distance up to 1000 feet. Suggested distance of 300 feet. Any error made in this measurement causes inaccurate line lengths.
2. Select "Start Calibration..." to begin the guided calibration process. This is the recommended process for calibration. Alternately, select "Edit Calibration..." to view or directly modify the calibration number.

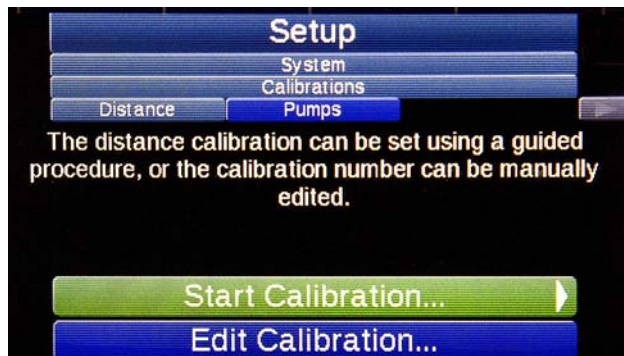

3. Align the vehicle with the start of a calibration course. Then select "Begin Calibrating".

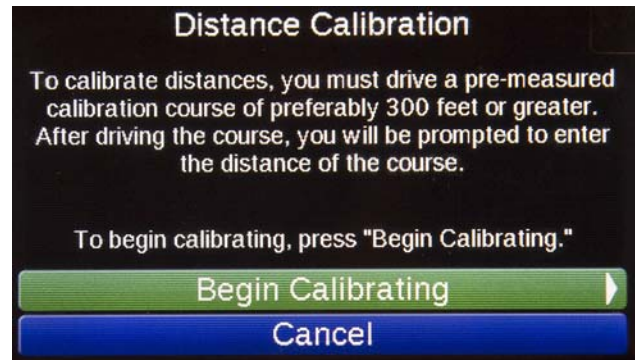

4. Drive the distance of the course. When you get to the finish point, select "Finish"

NOTE: The "Old Calibration Distance" number is likely incorrect. It is useful to see to ensure that motion pulses are being received.

5. Correct the distance measured, to the actual distance traveled and select "Save Calibration".

For Example: If the course was 300 feet and the measured distance was 281', you would change 281' to 300' on the screen.

6. If there was an error, verify the motion sensor is installed correctly and getting the correct pulses.

Pump Calibration/OEM Setup

The RoadPak Pumps come pre-calibrated and should not need changed. If a different pump is being used, follow the instructions below.



Pump calibrations are correlated to paint color in each pump.

1. Start by selecting a pump color to calibrate. Yellow, White, or Black.
2. Select "Start Calibration..." to begin the guided calibration process. This is the recommended process for calibration. Alternately, select "Edit Calibration..." to view or directly modify the calibration number.
3. Select a gun to use for the calibration and select "Begin Calibrating". Only select a gun that is plumbed to the pump you are calibrating.

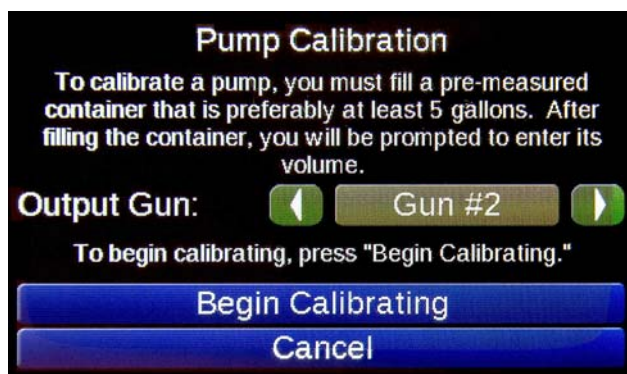

4. Place a container with known volume under this gun. Lower pump pressure to minimize over-spray.
5. Once the pre-measured container is under the selected gun, press "Start Paint" to begin the calibration. The button will change to "Stop Paint".

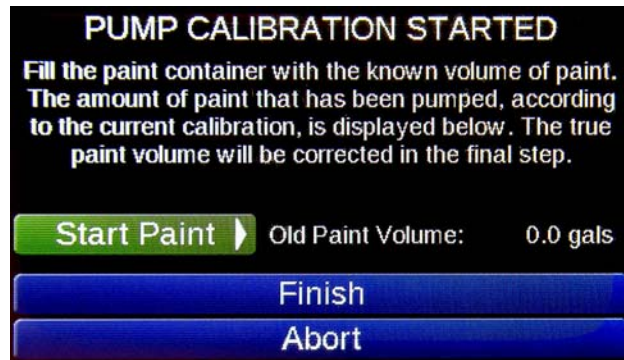

6. Once the pre-measured container has been filled to its pre-measure capacity, press "Stop Paint". If not yet filled, use "Start Paint"/"Stop Paint" until paint level is at the correct height.
7. Press "Finish" when done.
8. Adjust the number displayed to match the volume of the pre-measured container.

Units

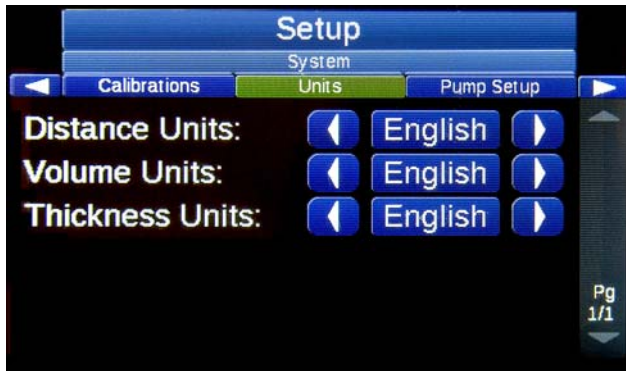

Adjust Unit for Distance, Volume and Thickness between English and Metric Units.

Pump Setup



Input what color each pump is set up with. This is necessary for proper data logging for Gallons pumped.

Life Totals

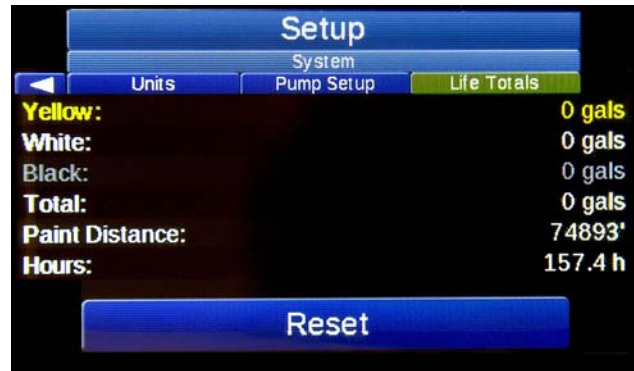

Life Totals provide a total number of painted distance and gallons pumped of each color. This number survives counter channel resets. The primary purpose of life totals is to assist the operator in knowing when to service pumps and other equipment.

The Life Totals are often reset at the time of equipment maintenance or rebuilds.

Gun Color



Set the color for each gun. The proper color setting is important for accuracy in mil thickness calculations, data logging, report printouts, and the pattern preview on the main screen.

NOTE: If a gun color is set to “None” that gun is will be disabled and will not fire even if it’s switch is in a skip or solid position. The gun indicator number in the pattern preview disappears on the main screen when it is disabled.

Gun Width

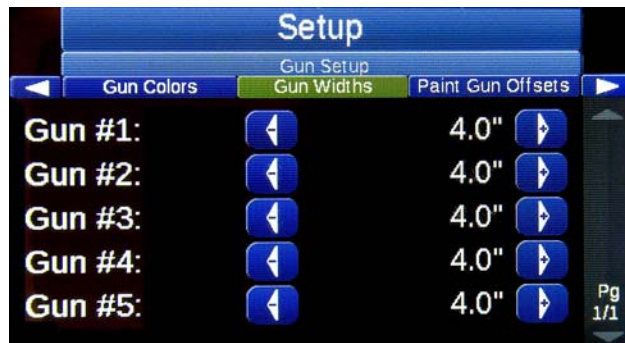

Set the gun widths to match the actual application width of the material on the road. Setting proper gun widths is important for accuracy in mil thickness, calculations, data logging, and report printouts.

Paint & Bead Gun Offsets

Paint Gun Offsets



Bead Gun Offsets



Gun offsets account for distance delays when marking the pattern. Set gun offsets for all items in the gun line.

Gun offsets are the distance from the front-most gun to the current gun. The front-most gun should be set to 0.00'.

IMPORTANT: Do not correct time factors with distance. Only distance factors should be corrected with distance, otherwise the skip timers will not be as accurate in placing paint and bead materials on top of each other at different vehicle speeds.

Paint & Bead Gun Delays

Paint Gun Delays

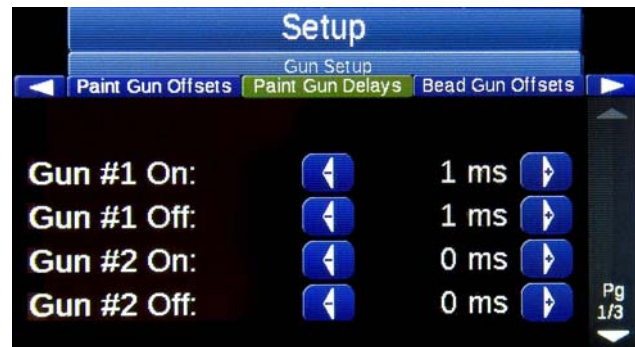

Bead Gun Delays



Gun delays correct the mechanical response delay of the gun. Most material applicators experience a time delay between the time the electrical signal is applied from the skip timer, until the gun actually opens and material can flow.

Some applicators take longer to turn off (pushing against high pressure) than to turn on (pushing with high pressure). This could cause a 10.0' striper, for example, to be longer, i.e. 10.5' to 11.0'.

With gun offsets already set correctly, adjust the gun factor to correct the line lengths.

Align Solids (Aligning Solid [no-passing] lines with skip lines)

The alignment tab allows the user the ability to choose where the solid lines (no-passing lines) will start and stop in relation to their skip line. This setting is enabled or disabled on the Quick Setup Page. **NOTE:** This feature can be viewed on the pattern preview.

The first green line represents the point where a solid line is activated. The second green line represents the point where the solid gun is deactivated or turned off.

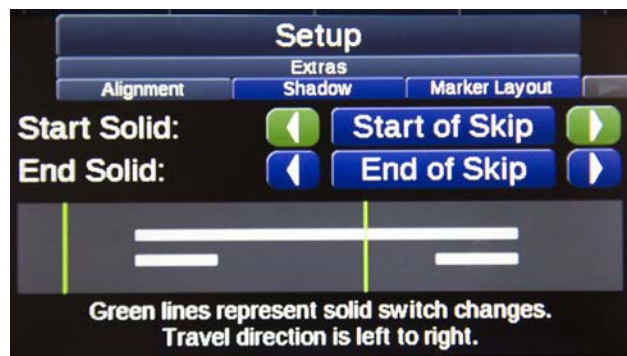
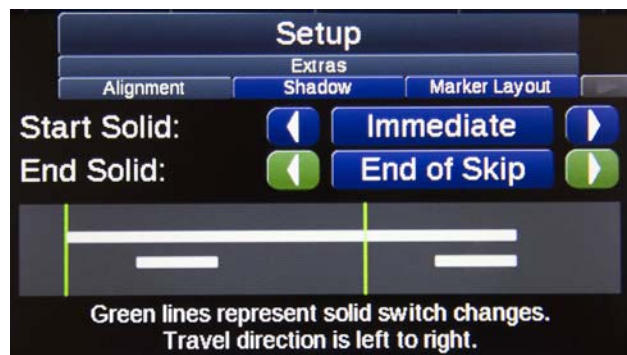
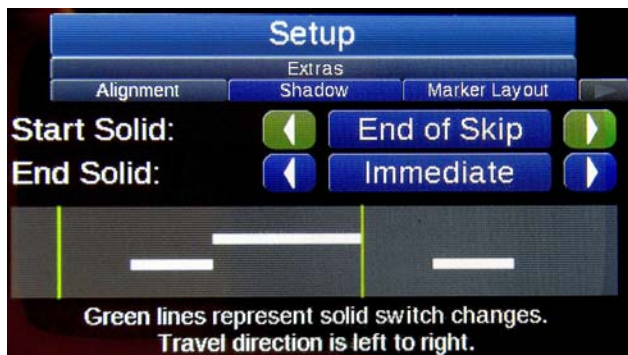
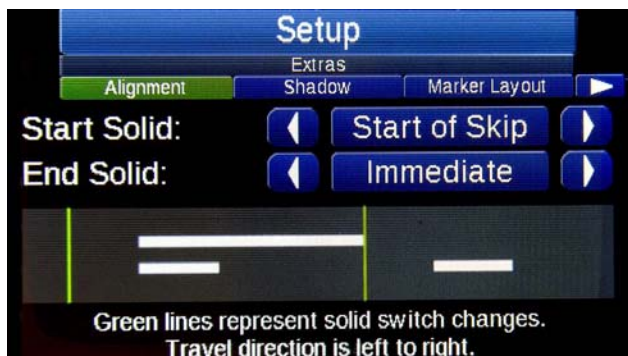

Shadow

Shadow mode can be enabled on the Quick Setup menu.

Shadow Mode applies paint before and/or after the stripe. When the shadow gun is in skip, the fore shadow/aft shadow lengths will be applied as entered in the setup menu.

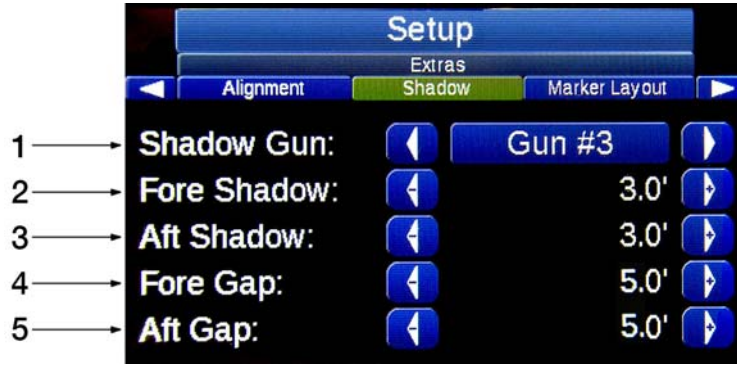

Ref.	Description
1	Shadow Gun
2	Fore Shadow: The length of paint to be applied before the beginning of the striper.
3	Aft Shadow: The length of paint to be applied after the end of the stripe.
4	Fore Gap: The space between the For Shadow and the stripe.
5	Aft Gap: The space between the Aft Shadow and the stripe.

NOTE: The shadow gun will be in-line with the skip pattern gun, and the proper paint gun offset will need to be entered into the controller.

NOTE: When the black gun is in solid, it will gap fill (i.e. black paint will be on for the entire gap between the end of the last stripe and the start of the next).

Shadow Line Example



Marker Layout

Marker Layout Mode can be enabled on the Quick Setup menu. When enabled, the main screen striper parameter is ignored and the marker layout patterns are engaged for the guns. The pattern preview area will show the current marker layout settings per the pattern setup. Choose a spray gun and toggle that switch to the skip position.

Create the desired patterns by setting the distance between markers in the Marker Layout Setup Menu.



Ref.	Description
1	Thirty different dot patterns can be saved and called up on the main screen.
2	Each dot pattern can have up to 40 consecutive measurements. By leaving zeros in any space, the Marker Layout Mode will skip to the next measurement in a continuous loop. Menu page 1 and 2 shown below.

Marker Layout Mode Example:

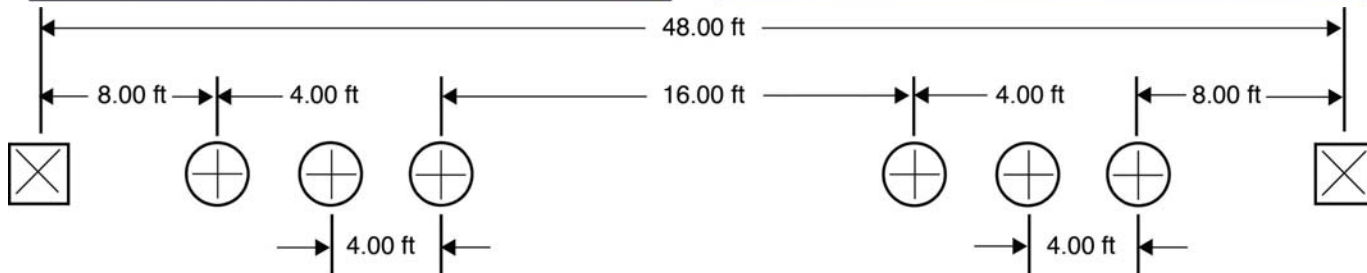

Dot size can be adjusted on Midspot Menu. See page XX.

Midspot

Midspot can be enabled or disabled on the Quick Setup Screen. Midspot parameters can be set in the Midspot Menu tab below. All midspots can be seen in the pattern preview.



Ref.	Description
1	Number of Dots: The number of dots to be laid between the skip lines. These will be centered and equally spaced.
2	Dot Spacing: The distance between each dot.
3	Dot Length: Sets the length. This controls Midspot and marker layout dot length.

Midspot Example:



Zipper

Zipper Mode can be enabled on the Quick Setup Screen. Zipper patterns must be set up in the Zipper Menu tab, and can be seen in the pattern preview on the Main Menu screen.



How to setup Zipper Patter:

- Set Gun Colors
- Set Second Rank
- Set Standard or Gap Fill
- Set Gun Offsets
- Set to Zipper Mode
- Check Pattern Preview

Second Rank

Second Rank is when one or more guns are a distance behind the other guns. See chart below for example:

Description
<p>Second Rank: None Imagine 5 guns lined up side by side. Since all 5 guns are in a line, there is no second rank.</p>
<p>Second Rank: Lines 2-5 Gun 1 is in front. Guns 2, 3, 4 and 5 are in a line but are a distance behind gun 1.</p>
<p>Second Rank: Lines 3-5 Gun 1 and 2 are in front. Guns 3, 4 and 5 are in a line but are a distance behind gun 1 and 2.</p>

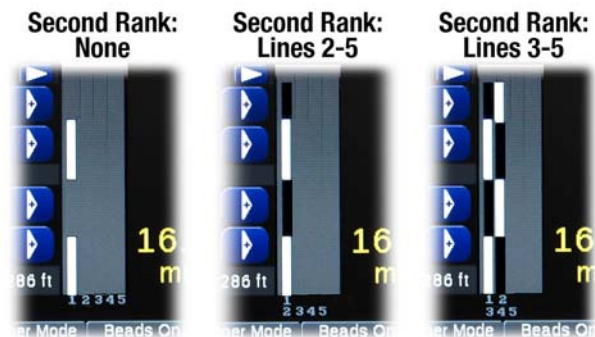

Second Rank can be set to apply only in Zipper Mode or in all modes on page 2.

Speed Range

Speed alarms will trigger when the START switch is on.

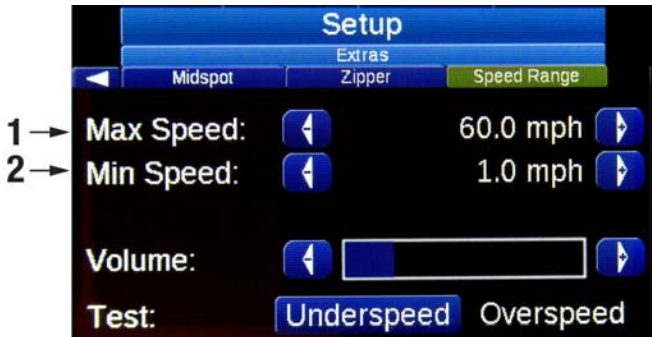

Ref.	Description
1	Maximum Speed: If speed rises above this value, the overspeed alarm will be triggered.
2	Minimum Speed: If speed falls below this value, the under-speed alarm will be triggered.

Switch Test

Verify switch functionality by flipping the switches and confirm they move on the screen. If a switch does not move on the screen, the signal is not being sent. The switch board will most likely need to be replaced.



Input Test

Connect an input ground. The corresponding icon should light up to show it is working.

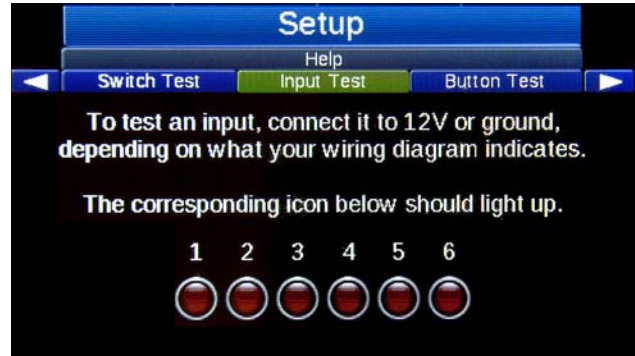

Button Test

Test the A,B,C,D buttons and the joystick command. If the corresponding symbol on the screen doesn't illuminate, the button board or joystick may need replaced.

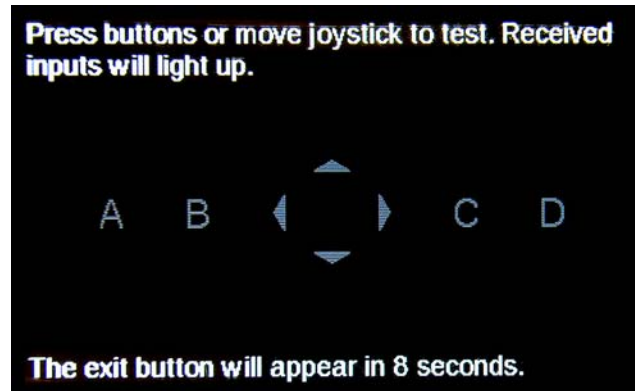
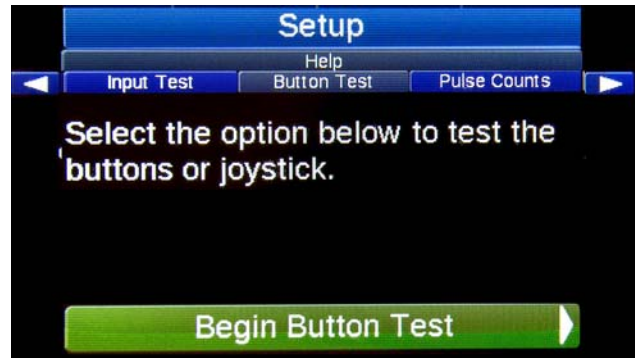

Pulse Counts

Distance counter and pump counters can be checked for functionality from this screen. One revolution should result in 50 +/-2 tooth counts for the distance sensor. Each pump cycle should be 1 pump pulse for the different pump.



GPS Status

To ensure the GPS antenna is properly working

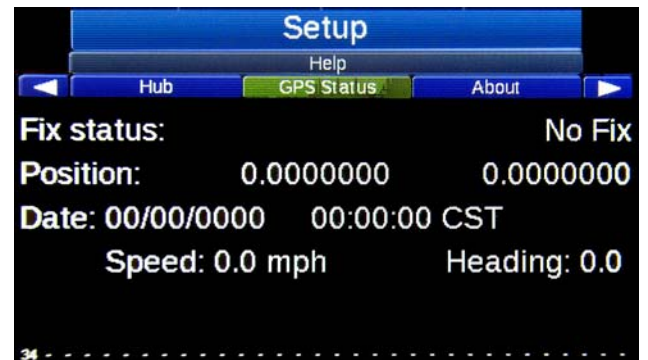

System Delay Setup

The start and stop of the guns in either solid lines or skiplines may be delayed by a specified distance. The One Operator System Delay™ is designed to make the striping job a one person operation by eliminating the need to look back at the guns to trigger them at the correct time. With the System Delay set, all gun activity is controlled using the mechanical pointer reference point on the road ahead of the vehicle.

1. Enable the System Delay in Quick Setup.



2. Sight the mechanical pointer with start of paint stripe (B).
3. Measure delay distance from start of paint stripe to gun. Measure from (A) to (B).
4. Enter measured delay distance.



When system delay is ON, all gun switches including HOLD/RESET will be delayed by the distance set in system delay.

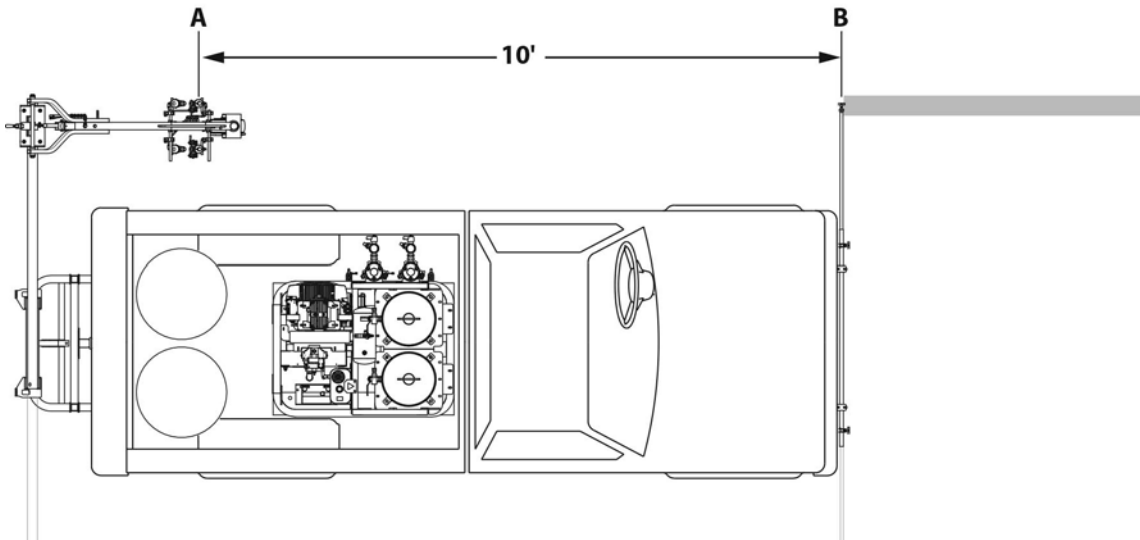

Troubleshooting

Problem	Cause	Solution
Control will not turn on.	12 VDC power supply low, or disconnected.	Connect the I/O cable. Charge the RoadLazer battery. Check the battery connections.
Guns will not spray.	Various causes.	Toggle RESET on the controller. Check the paint supply. Check the gun ball valves. See manual 306861. Check the RoadLazer and engine fuses. See manual 308611 or 3A1214 and separate engine manual.
MPH readout reads zero, or inconsistent reading.	Improper sensor alignment.	Sensor should be .03 in. from the timing gear, and centered.
Glass beads miss a portion of a stripe when turned on.	Paint and bead gun delays not set properly.	Adjust Paint and Bead Gun Delay values.
Glass beads stay on longer than the paint guns, wasting beads.	Bead Off Delay is too high.	Lower the Bead Off Delay value.
Skipline is longer than the actual programmed distance.	The gun solenoids are taking longer to turn off than to turn on.	Increase the value of the Paint Gun on Delay.
Guns will not stop spraying.	The system delay is set to ON while the vehicle is stopped. Gun needle and seat are worn out.	Turn the Skipline Controller's main power switch OFF. Replace. See manual 308613.

Information System

The Information System Menu provides a descriptive alert system to assist with understanding current activity, warnings, and critical errors that need attention.

Information messages assist the operator in understanding certain behaviors or conditions that may be intentional, but could be confusing or interpreted as incorrect behavior due to setting configurations.



Description
Clear Alert: Scroll the joystick down to the “Clear” command button on the message. Most messages will disappear if the related error condition is no longer detected.
Audible Chime: Each message level (info, warning, error) has a distinct audible chime. These let the operator know audibly when there is an issue.
Warning and Error Messages will automatically disappear after the problem is no longer detected.
Information Messages will not reappear for the same event when cleared by the operator. However, warning and critical error messages will reappear in two minutes after being cleared by the operator when the problem is still detected by the system.

Parts

OEM Kit (25D887) and Control Kit (25M711)

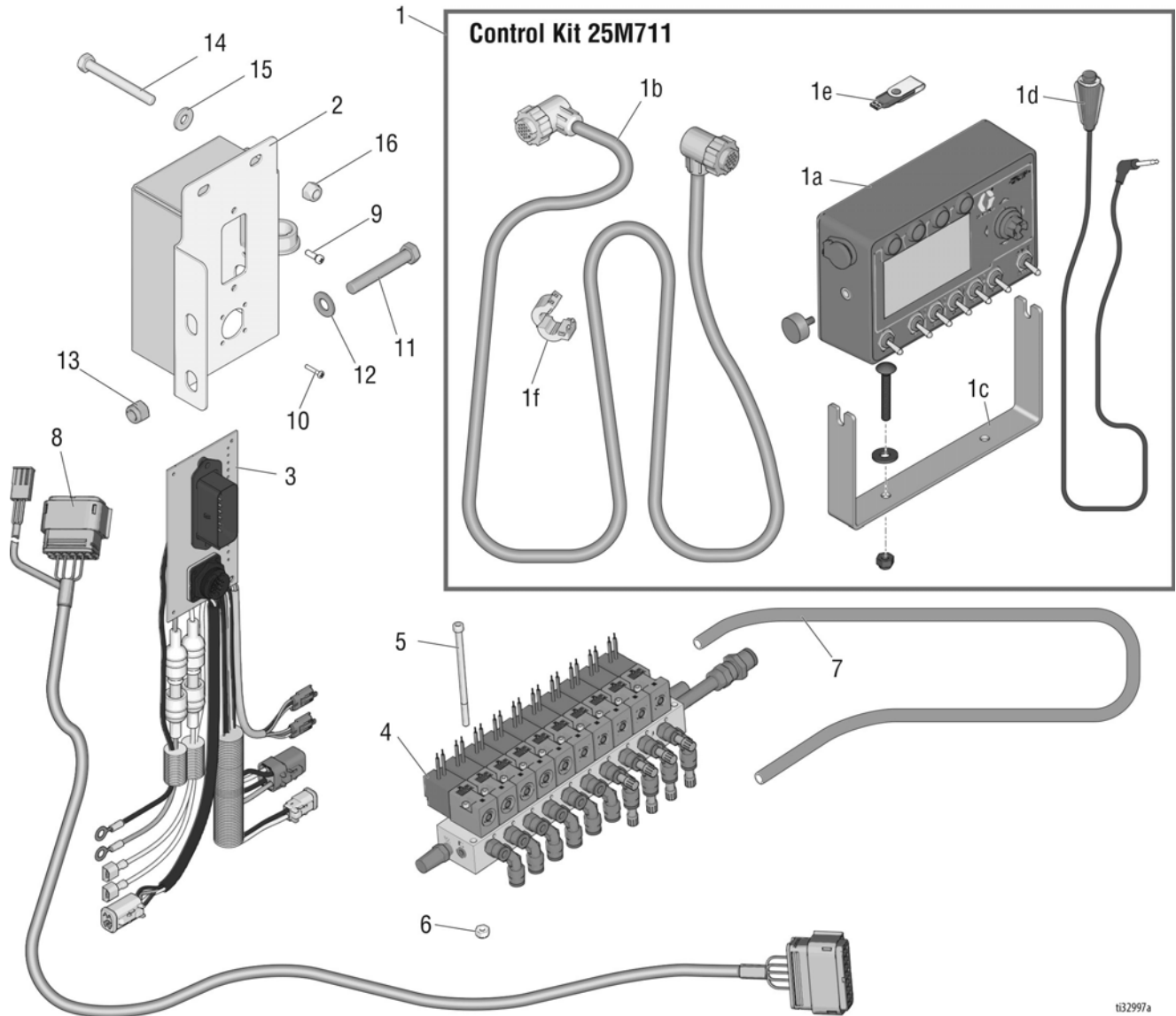

132997a

Ref.	Part	Description	Qty.	Ref.	Part	Description	Qty.
1	25M711	KIT, control, RoadPak/HD	1	6	116969	NUT, lock, #10-24	2
1a	24S169	CONTROL, RoadPak/HD, SkipLine	1	7	16G833	HOSE, air	1
1b	24F469	CABLE, 18 control, 30 ft.	1	8	131237	CABLE, solenoids, 23 ft.	1
1c	17V199	BRACKET, control, SkipLine	1	9	120463	SCREW, machine, #8-32 x .5"	2
1d	113617	SWITCH, remote	1	10	111714	SCREW, machine #4-40 x 6.25"	4
1e	17L724	FLASH DRIVE, USB 2.0	1	11	516595	BOLT, hex, 3/8-16 x 2.5"	2
1f	17V688	SUPPRESSOR, ferrite	1	12	100731	WASHER, 3/8"	4
2	17U066	BOX, junction, RoadPak/HD	1	13	101566	NUT, lock, 3/8-16	2
3	25M795	KIT, control, RoadPak/HD	1	14	113664	SCREW, cap, 5/16-18 x 2.75"	2
4	17U196	SOLENOID, air, 10-position	1	15	100527	WASHER, 5/16"	4
5	124983	SCREW, cap, #10-24 x 3.75"	2	16	111040	NUT, lock, 5/16-18	2

Wiring Diagram

Schematics - OEM Components

Control Cable Diagram for RoadPak System

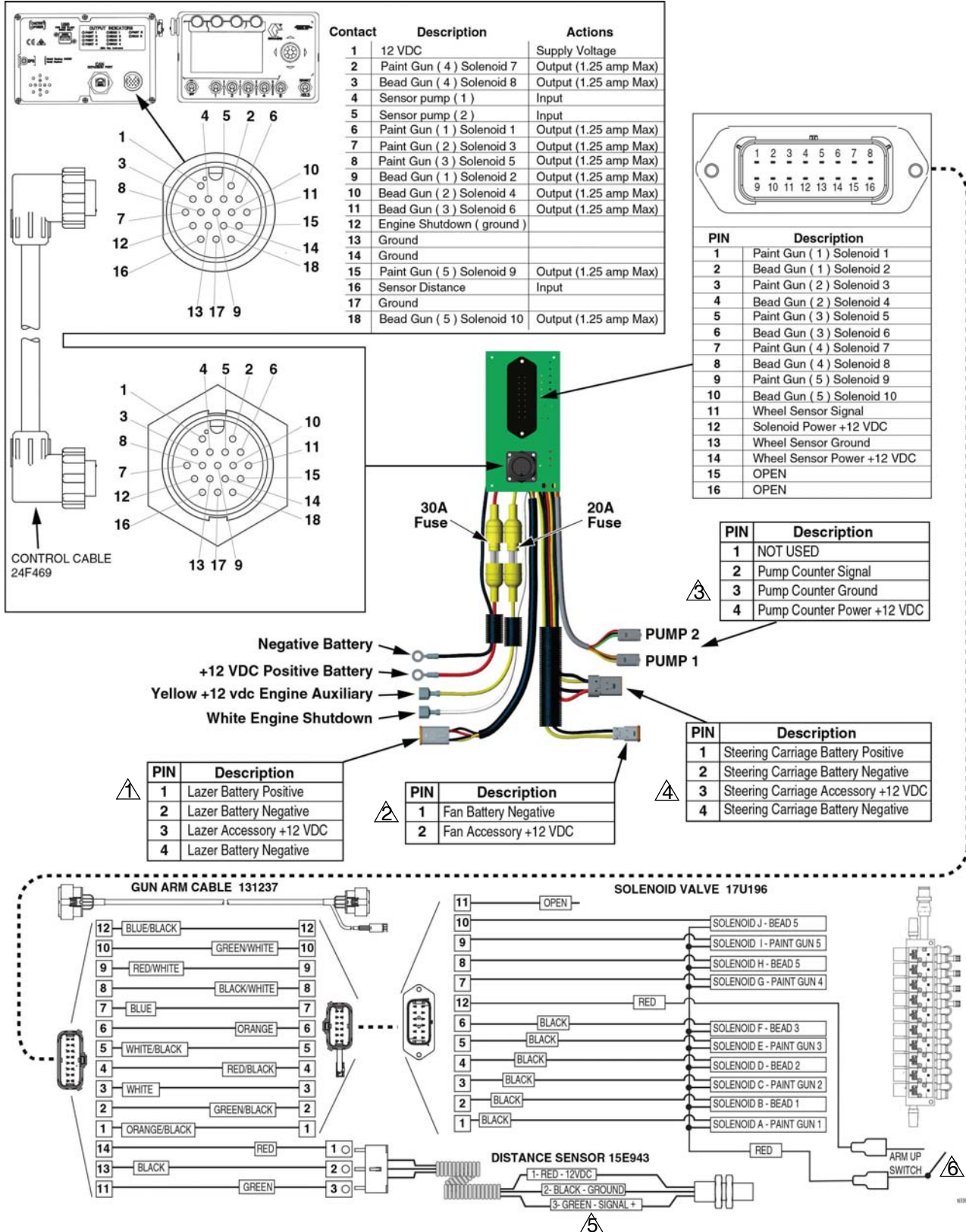

OEM Installation

Additional Accessories and Electrical Options

- △ Plug in for LazerGuide 3000 Long-Line Laser PN 17U930
- △ Plug in for optional cooling fan or use for other accessories not supplied by Graco
- △ Plug in for Pump Counter PN 16J511
- △ Plug in for Steerable Carriage PN 25M712 (can only be used with RoadPak Gun Arms)
Use in conjunction with Rear Seat Kit PN 25M716
- △ Plug in for Distance Sensor PN 15E943 or Sensor Kit 287968
- △ Arm up switch
 - Option 1: Bypass by splicing wires together
 - Option 2: Purchase switch PN 116833 and install switch to activate when gun carriage is stowed to prevent premature gun activation during transport

Technical Specifications

Skipline Controller		
	US	Metric
Electrical Requirements		
Control		12Vdc
Sender input		12Vdc
Ground		Negative
Gun output switch to ground		2A max
Reverse polarity and noisy sparks		Protected
Operating speed range		
	Up to 20 mph	Up to 32 kph
Operating temperature		
	32 - 130° F	0 - 54° C
Storage temperature		
	10 - 160° F	-12 - 71° C
Weight		
	3 lbs.	1.4 kg
Dimensions		
	7.25 in. x 4.50 in. x 2.25 in.	184 mm x 114 mm x 57 mm

Graco Standard Warranty

Graco warrants all equipment referenced in this document which is manufactured by Graco and bearing its name to be free from defects in material and workmanship on the date of sale to the original purchaser for use. With the exception of any special, extended, or limited warranty published by Graco, Graco will, for a period of twelve months from the date of sale, repair or replace any part of the equipment determined by Graco to be defective. This warranty applies only when the equipment is installed, operated and maintained in accordance with Graco's written recommendations.

This warranty does not cover, and Graco shall not be liable for general wear and tear, or any malfunction, damage or wear caused by faulty installation, misapplication, abrasion, corrosion, inadequate or improper maintenance, negligence, accident, tampering, or substitution of non-Graco component parts. Nor shall Graco be liable for malfunction, damage or wear caused by the incompatibility of Graco equipment with structures, accessories, equipment or materials not supplied by Graco, or the improper design, manufacture, installation, operation or maintenance of structures, accessories, equipment or materials not supplied by Graco.

This warranty is conditioned upon the prepaid return of the equipment claimed to be defective to an authorized Graco distributor for verification of the claimed defect. If the claimed defect is verified, Graco will repair or replace free of charge any defective parts. The equipment will be returned to the original purchaser transportation prepaid. If inspection of the equipment does not disclose any defect in material or workmanship, repairs will be made at a reasonable charge, which charges may include the costs of parts, labor, and transportation.

THIS WARRANTY IS EXCLUSIVE, AND IS IN LIEU OF ANY OTHER WARRANTIES, EXPRESS OR IMPLIED, INCLUDING BUT NOT LIMITED TO WARRANTY OF MERCHANTABILITY OR WARRANTY OF FITNESS FOR A PARTICULAR PURPOSE.

Graco's sole obligation and buyer's sole remedy for any breach of warranty shall be as set forth above. The buyer agrees that no other remedy (including, but not limited to, incidental or consequential damages for lost profits, lost sales, injury to person or property, or any other incidental or consequential loss) shall be available. Any action for breach of warranty must be brought within two (2) years of the date of sale.

GRACO MAKES NO WARRANTY, AND DISCLAIMS ALL IMPLIED WARRANTIES OF MERCHANTABILITY AND FITNESS FOR A PARTICULAR PURPOSE, IN CONNECTION WITH ACCESSORIES, EQUIPMENT, MATERIALS OR COMPONENTS SOLD BUT NOT MANUFACTURED BY GRACO. These items sold, but not manufactured by Graco (such as electric motors, switches, hose, etc.), are subject to the warranty, if any, of their manufacturer. Graco will provide purchaser with reasonable assistance in making any claim for breach of these warranties.

In no event will Graco be liable for indirect, incidental, special or consequential damages resulting from Graco supplying equipment hereunder, or the furnishing, performance, or use of any products or other goods sold hereto, whether due to a breach of contract, breach of warranty, the negligence of Graco, or otherwise.

Graco Information

For the latest information about Graco products, visit www.graco.com.

For patent information, see www.graco.com/patents.

TO PLACE AN ORDER, contact your Graco distributor or call 1-800-690-2894 to identify the nearest distributor.

*All written and visual data contained in this document reflects the latest product information available at the time of publication.
Graco reserves the right to make changes at any time without notice.*

Original instructions. This manual contains English. MM 3A5387

Graco Headquarters: Minneapolis

International Offices: Belgium, China, Japan, Korea

GRACO INC. AND SUBSIDIARIES • P.O. BOX 1441 • MINNEAPOLIS MN 55440-1441 • USA
Copyright 2017, Graco Inc. All Graco manufacturing locations are registered to ISO 9001.

www.graco.com

Revision B, May 2019